

LYOPRO

LEVEL

2023-2024
NEW PRODUCT CATALOGUE

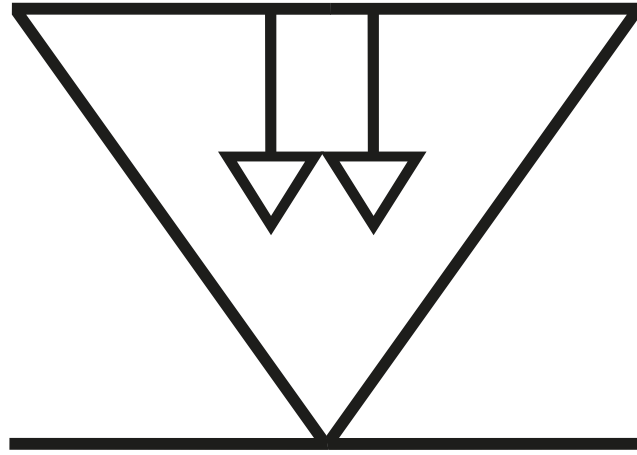

LYOPRO

LEVEL

Lighting with you

LYOPRO es una empresa joven y dinámica que da mucha importancia a la **luz** tanto en interiores como en exteriores.

Realizamos proyectos de iluminación mediante un completo estudio lumínico tras conversación con el equipo de trabajo (**distribución sobre plano, fotomontajes, cálculos lumínicos, renderizados y 3D**), ajustándonos a las necesidades tanto económicas como estéticas, aportando ideas innovadoras y creativas para conseguir que la luz forme parte de la decoración.

Minucioso **seguimiento a pie de obra**, estableciendo reuniones con los profesionales para garantizar los resultados.

*LYOPRO is a young and dynamic company that attaches great importance to **light** both indoors and outdoors.*

*We carry out lighting projects through a complete lighting study after conversation with the work team (**plan distribution, photomontages, lighting calculations, renderings and 3D**), adjusting to both economic and aesthetic needs, providing innovative and creative ideas to ensure that light become part of the decor.*

*Detailed **follow-up on site**, establishing meetings with professionals to guarantee results.*

LYOPRO est une entreprise jeune et dynamique qui attache une grande importance à la **lumière** aussi bien en intérieur qu'en extérieur.

Nous réalisons des projets d'éclairage à travers une étude d'éclairage complète après conversation avec l'équipe de travail (**distribution des plans, photomontages, calculs d'éclairage, rendus et 3D**), en nous adaptant aux besoins économiques et esthétiques, en apportant des idées innovantes et créatives pour que la lumière fasse partie de le décor.

Suivi **détaillé sur place**, mise en place de rencontres avec des professionnels pour garantir les résultats.



CATÁLOGO LEVEL

LYOPRO vamos más allá en su progresión y desarrollamos un catálogo donde queremos hacer patente la consolidación de nuestra marca en un sector especializado como es el mundo del **CONTRACT**, la arquitectura e ingeniería. Para ello plasmamos en nuestro catálogo **LEVEL**, todas aquellas necesidades que los profesionales se encuentran para poder seleccionar luminarias acordes a los requerimientos que se solicitan en una obra, ya sea a nivel estético, económico, rendimientos, garantías, etc, además de dar a nuestros clientes la posibilidad de confeccionar sus propias luminarias, eligiendo colores, ópticas, formas, etc, en un gran número de los artículos presentados. Con **LEVEL** podemos alcanzar cualquier objetivo lumínico que se nos brinde.

Para ello **LYOPRO LEVEL** cuenta en su contenido con un gran número de luminarias con un elevado confort visual, rendimiento y prestaciones.

*LYOPRO goes further in its progression and we develop a catalog where we want to make clear the consolidation of our brand in a specialized sector such as the world of **CONTRACT**, architecture and engineering. For this, we capture in our **LEVEL** catalog, all those needs that professionals find to be able to select luminaires according to the requirements that are requested in a work, be it aesthetically, economically, yields, guarantees, etc., in addition to giving our customers the possibility of making their own luminaires, choosing colors, optics, shapes, etc., in a large number of the articles presented. With **LEVEL** we can achieve any lighting objective that is given to us.*

*For this, **LYOPRO LEVEL** has in its content a large number of luminaires with high visual comfort, performance and benefits.*

LYOPRO va plus loin dans sa progression et nous développons un catalogue où nous voulons souligner la consolidation de notre marque dans un secteur spécialisé tel que le monde du **CONTRAT**, de l'architecture et de l'ingénierie. Pour cela, nous capturons dans notre catalogue **LEVEL**, tous les besoins que les professionnels trouvent pour pouvoir sélectionner les luminaires en fonction des exigences demandées dans un travail, que ce soit esthétiquement, économiquement, rendements, garanties, etc., en plus de donner à nos clients la possibilité de réaliser leurs propres luminaires, en choisissant les couleurs, les optiques, les formes, etc., dans un grand nombre d'articles présentés. Avec **LEVEL**, nous pouvons atteindre n'importe quel objectif d'éclairage qui nous est donné.

Pour cela, **LYOPRO LEVEL** dispose dans son contenu d'un grand nombre de luminaires à haut confort visuel, performances et prestations.

SHOWROOM

Lyopro Showroom es una nueva forma de enseñar nuestras luminarias al mundo. Un espacio creado para que nuestros clientes puedan ver en directo el impacto lumínico de las luminarias y su componente estético, diseño, material y calidad de todos y cada uno de los productos que conforman los distintos portfolios de nuestra marca. Un lugar construido a través de diferentes estancias para poder comprobar todo aquello que necesitas para seleccionar aquello que más le conviene a tu proyecto. Este proyecto de Showroom en Valencia nace de la necesidad de que nuestros clientes puedan conocer las luminarias que les recomendamos en cada uno de sus proyectos, es un espacio de creación en común con nuestros clientes. En nuestro Lyopro Showroom, podrás pasear por diferentes estancias en las que ver en funcionamiento nuestras luminarias más características de nuestros catálogos: LYOPRO IDENTITY, LYOPRO LED PROFILE, LYOPRO LEVEL.

Disponemos de una red de Técnicos Comerciales expertos en el asesoramiento con nuestros clientes.

Lyopro Showroom is a new way of exhibiting and displaying our lighting solutions to the public. We created this space so that our clients can have a closer look at all the details of the lighting products from the different collections, such as their aesthetic, design, materials and quality. A place built through different stays to be able to check everything you need to select what you most suits your project. We conceptualised the Valencia showroom with the needs of our clients in mind because we wanted to be able to showcase our products. At the Lyopro Showroom, you can walk through different rooms where you can see our most well known products from our catalogues: LYOPRO IDENTITY, LYOPRO LED PROFILE, LYOPRO LEVEL.

There is also always a commercial technician, who can assist you with their expertise.

Lyopro Showroom est une nouvelle façon de montrer nos luminaires au monde entier. Un espace créé pour que nos clients puissent voir en direct l'impact lumineux des luminaires et leur composante esthétique, leur design, leurs matériaux et la qualité de chacun des produits qui composent les différents portefeuilles de notre marque. Un endroit construit à travers différentes pièces pour vérifier tout ce dont vous avez besoin pour sélectionner ce qui convient à votre projet. Ce projet de showroom à Valence est né du besoin pour nos clients de connaître les luminaires que nous recommandons dans chacun de leurs projets, c'est un espace de création en commun avec nos clients. Dans notre Lyopro Showroom, vous pouvez vous promener dans différentes salles où vous pouvez voir en fonctionnement nos luminaires les plus caractéristiques de nos catalogues: LYOPRO IDENTITY, LYOPRO LED PROFILE, LYOPRO LEVEL.

Nous disposons d'un réseau de techniciens commerciaux experts pour conseiller nos clients



SHOWROOM:

Avenida Tres Cruces, 63 - 46014 Valencia

SIMBOLOGÍA / SYMBOLS / SYMBOLES

	Led Chip Edison <i>Led chip Edison</i> Puce led Edison		Grado de impermeabilidad y resistencia al polvo <i>Degree of impermeability and resistance to dust</i> Degré d'imperméabilité et de résistance à la poussière		Instalación interior <i>Indoor installation</i> Installation intérieure
	Led Chip Brigelux <i>Led chip Brigelux</i> Puce led Brigelux		Certificación diseñada para asegurar que el equipo pueda resistir los lavados a alta presión y con vapor <i>Certification designed to ensure equipment can withstand high pressure and steam wash downs</i> Certification conçue pour garantir que l'équipement peut résister aux hautes pressions et aux lavages à la vapeur		Instalación exterior <i>Outdoor installation</i> Installation extérieure
	Led Chip Cree <i>Led chip Cree</i> Puce led Cree		Resistencia mecánica a los golpes <i>Résistance mécanique aux chocs</i> Mechanical resistance to shock		Instalación en pared <i>Wall installation</i> Montage mural
	Led Chip Epistar <i>Led chip Epistar</i> Puce led Epistar		Temperatura de trabajo <i>Work temperature</i> Température de travail		Instalación en suelo <i>Ground installation</i> Mise en place au sol
	Led Chip Ever Light <i>Led chip Ever Light</i> Puce led Ever Light		Equipo incluido <i>Equipment included</i> Équipement inclus		Instalación en techo <i>Ceiling installation</i> Installation au plafond
	Led Chip Lumileds <i>Led chip Lumileds</i> Puce led Lumileds		Equipo no incluido <i>Equipment not included</i> Équipement non inclus		Instalación en pared o suelo <i>Wall or floor installation</i> Pose au mur ou au sol
	Led Chip Sanan <i>Led chip Sanan</i> Puce led Sanan		Clase I - clase de aislamiento eléctrico (IEC) <i>Equipment in Class I - electrical insulation class (IEC)</i> Équipement en classe I - classe d'isolation électrique (CEI)		Instalación en techo o pared <i>Ceiling or wall installation</i> Installation au plafond ou au mur
	Led Chip Seoul <i>Led chip Seoul</i> Puce led Seoul		Clase II - clase de aislamiento eléctrico (IEC) <i>Class II - electrical insulation class (IEC)</i> Classe II - classe d'isolation électrique (CEI)		Instalación en techo, pared o suelo <i>Installation on ceiling, wall or floor</i> Installation au plafond, au mur ou au sol
	Led Chip Samsung <i>Led chip Samsung</i> Puce led Samsung		Clase III - clase de aislamiento eléctrico (IEC) <i>Class III - electrical insulation class (IEC)</i> Classe III - classe d'isolation électrique (CEI)		Instalación en techo o suelo <i>Ceiling or floor installation</i> Installation au plafond ou au sol
	Led Chip Special R • G • O <i>Led chip Special R • G • O</i> Puce led Special R • G • O		Dispositivo para tránsito de vehículos <i>Vehicle transit device</i> Dispositif de transit de véhicule		Instalación colgante <i>Hanging installation</i> Pose suspendue
	Led Chip Luminus <i>Led chip Luminus</i> Puce led Luminus		Pisable por paso humano <i>Walkable by human step</i> Praticable à pas humain		Color <i>Color</i> Couleur
	Led Chip Tridonic <i>Led chip Tridonic</i> Puce led Tridonic		Haz de luz orientable <i>Adjustable light beam</i> Faisceau lumineux réglable		Blanco <i>White</i> Blanc
	Led Driver Tridonic <i>Led Driver Tridonic</i> Pilote Led Tridonic		Haz de luz basculante <i>Tilting light beam</i> Faisceau lumineux inclinable		Negro <i>Black</i> Noir
	Led Driver Sosen <i>Led Driver Sosen</i> Pilote Led Sosen		Caja de empotrar incluida <i>Embedding box included</i> Boîte d'encastrement incluse		Oro <i>Gold</i> Or
	Led Driver Mean Well <i>Led Driver Mean Well</i> Pilote Led Mean Well		Instalación sin marco <i>Frameless Installation</i> Installation sans cadre		Antracita <i>Anthracite</i> Anthracite
	Led Driver Edison <i>Led Driver Edison</i> Pilote Led Edison		Possibilidad de pintado <i>Possibility of painting</i> Possibilité de peinture		Gris <i>Grey</i> Gris
	Led Driver Hep <i>Led Driver Hep</i> Pilote Led Hep		Agujero de instalación cuadrado <i>Square installation hole</i> Trou d'installation carré		Plata <i>Silver</i> Argent
	Led Driver Osram <i>Led Driver Osram</i> Pilote Led Osram		Agujero de instalación redondo <i>Round installation hole</i> Trou d'installation rond		Gris Texturizado <i>Textured Grey</i> Gris texturé
	Led Driver Eaglerise <i>Led Driver Eaglerise</i> Pilote Led Eaglerise		Conformidad con los estándares de la UE <i>Compliance with EU standards</i> Conformité aux normes de l'UE		Blanco/Rojo <i>White Red</i> Blanc rouge
	Led Driver Lifud <i>Led Driver Lifud</i> Pilote Led Lifud		Años de garantía <i>Years warranty</i> ans de garantie		Blanco/Oro <i>White/Gold</i> Or blanc
	Led Driver Kegu <i>Led Driver Kegu</i> Pilote Led Kegu		Años de garantía <i>Years warranty</i> ans de garantie		Blanco/Negro <i>Black White</i> Noir blanc
	Led Driver Boke <i>Led Driver Boke</i> Pilote Led Boke		Atmósfera explosiva <i>Explosive atmosphere</i> Atmosphère explosive		Plata Mate <i>Matt silver</i> Argent mat
	Led Driver Inventronics <i>Led Driver Inventronics</i> Pilote Led Inventronics		Atmósfera explosiva <i>Explosive atmosphere</i> Atmosphère explosive		Plata Brillo <i>Shiny Silver</i> Argent brillant
	Smart Control <i>Smart Control</i> Contrôle intelligent		Cable de alimentación incluido <i>Power cord included</i> Cordon d'alimentation inclus		Piedra <i>Stone</i> Pierre
	Voltaje <i>Voltage</i> Tensión		Sumergible <i>Submersible</i> Submersible		Blanco/Plata Mate <i>White/Matt Silver</i> Blanc/Argent Mat
	Disponible en versión emergencia <i>Available in emergency version</i> Disponible en version d'urgence		Solar <i>Solar</i> Solaire		Blanco/Plata Brillo <i>White/Gloss Silver</i> Blanc/Argent Brillant
	Protector sobretensiones <i>Surge protector</i> Parasurtenseur		Batería / <i>Battery</i> / Batterie		Inoxidable <i>Stainless</i> Inoxydable
	Cociente de deslumbramiento <i>Glare quotient</i> Quotient d'éblouissement		Tensión 12V VDC / <i>Voltage 12V VDC</i> / Tension 12V cc		Acero cepillado <i>Brushed steel</i> Acier brossé
	UGR <		Tensión 24V VDC / <i>Voltage 24V VDC</i> / Tension 24V cc		Bajo Proyecto <i>Under project</i> En projet
			Reproducción cromática <i>Color rendering</i> Rendu des couleurs		

COMO INTERPRETAR NUESTRO CATÁLOGO/HOW TO INTERPRET OUR CATALOG/ COMMENT INTERPRÉTER NOTRE CATALOGUE

- | | | | |
|-----|--|-----|--|
| 0. | Nombre del artículo/ <i>Article name</i> /Nom d'article | 14. | Certificado "CE" / "CE" certificate/Certificat "CE" |
| 1. | Fabricante del Chip/ <i>Chip Manufacturer</i> / Fabricant de puces | 15. | Años de Garantía/ <i>Years warranty</i> /Ans de garantie |
| 2. | Fabricante del Driver/ <i>Driver Manufacturer</i> /Fabricant du pilote | 16. | Medida exterior luminaria/ <i>External measurement of luminaire</i> /Mesure externe du luminaire |
| 3. | Grado de Estanqueidad/ <i>Tightness Degree</i> /Degré d'étanchéité | 17. | Medida de corte luminaria/ <i>Luminaire cutting measure</i> / Mesure de coupe du luminaire |
| 4. | Índice de deslumbramiento/ <i>Glare index</i> /Indice d'éblouissement | 18. | Código/ <i>Code</i> /Code |
| 5. | Protector sobretensiones/ <i>Surge protector</i> / parasurtenseur | 19. | Wattios de luminaria/ <i>Luminaire Watts</i> / Puissance des luminaires |
| 6. | Clase de protección/ <i>Protection class</i> /Classe de protection | 20. | Lumen de luminaria/ <i>Luminaire lumen</i> /Lumière du luminaire |
| 7. | Voltaje/ <i>Voltage</i> /Tension | 21. | Grados Kelvin de luminaria/ <i>Kelvin degrees of luminaire</i> / Degrés Kelvin du luminaire |
| 8. | Material/ <i>Material</i> /Matériel | 22. | Versión de luminaria/ <i>Luminaire version</i> /Version luminaire |
| 9. | Posibilidad de luminaria con kit de emergencia/ <i>Possibility of luminaire with emergency kit</i> / Possibilité de luminaire avec kit d'urgence | 23. | Ángulo de apertura/ <i>Opening angle</i> / Angle d'ouverture |
| 10. | Reproducción cromática/ <i>Color rendering</i> /Rendu des couleurs | 24. | Color luminaria/ <i>Luminaire color</i> /Couleur luminaire |
| 11. | Equipo incluido/ <i>Equipment included</i> /Équipement inclus | 25. | Tipo de regulación/ <i>Regulation type</i> /Type de régulation |
| 12. | Área de aplicación INTERIOR - EXTERIOR/ <i>INDOOR - OUTDOOR application area</i> /Domaine d'application INTÉRIEUR - EXTÉRIEUR | 26. | Smart control/ <i>Smart control</i> /Contrôle intelligent |
| 13. | Tipo de instalación a TECHO/ <i>CEILING installation type</i> /Type d'installation au PLAFOND | | |

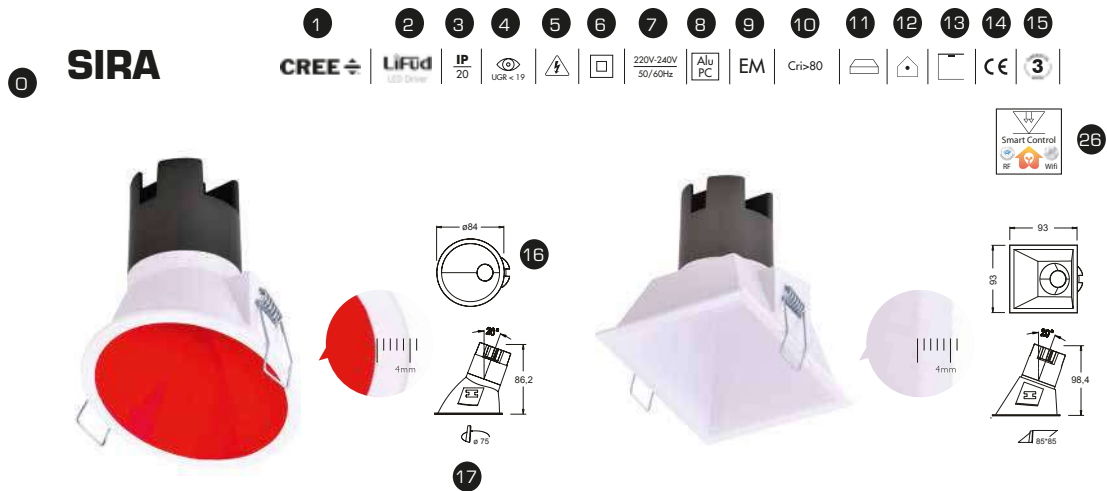

CÓDIGO	W	LM	K	VERSIÓN	ÓPTICA°		ELECTRÓNICA
60300	5w	475Lm	3000K	RA Redondo Asimétrica	15	B	SR ON/OFF
60301	5w	500Lm	4000K	CA Cuadrado Asimétrica	24	N	A PUSH
					38	BR	B 1-10V
						BO	C DALI
						BPM	
						BN	

COMO COMPLETAR EL CÓDIGO PARA UNA SOLICITUD HOW TO COMPLETE THE CODE FOR AN APPLICATION COMMENT REMPLIR LE CODE POUR UNE DEMANDE

CÓDIGO	W	LM	K	VERSIÓN	ÓPTICA°		ELECTRÓNICA
60300	5w	475Lm	3000K	RA Redondo Asimétrica	15	B	SR ON/OFF
60301	5w	500Lm	4000K	CA Cuadrado Asimétrica	24	N	A PUSH
					38	BR	B 1-10V
						BO	C DALI
						BPM	
						BN	

CÓDIGO FINAL **60300** **RA** **15** **B** **SR**

Seleccionar todas aquellas posibilidades que están resaltadas en color AZUL en el orden de izquierda a derecha
 Select all those possibilities that are highlighted in BLUE color in the order from left to right
 Sélectionnez toutes les possibilités qui sont surlignées en BLUE dans l'ordre de gauche à droite

60300RA15BSR Downlight Sira Emp. Red. Asim. 5w 3000K 15 BLANCO SR
CÓDIGO + VERSIÓN + ÓPTICA + COLOR + ELECTRÓNICA
CODE + VERSION + OPTICS + COLOR + ELECTRONICS
CODE + VERSION + OPTIQUE + COULEUR + ÉLECTRONIQUE

ÍNDICE / INDEX / INDICE

MINI DOWNLIGHTS DE EMPOTRAR/ RECESSED MINI DOWNLIGHTS/ MINI DOWNLIGHTS ENCASTRÉS



AGATE Pag. 13



ELIAN Pag. 13



ARASH Pag. 14



LISA Pag. 16

DOWNLIGHTS DE EMPOTRAR/ RECESSED DOWNLIGHTS/ DOWNLIGHTS ENCASTRÉS



SIRA Pag. 18-24



LUNA Pag. 26



DELIA Pag. 28



ZORA Pag. 20-34



DEO Pag. 36



RHEA Pag. 37



SWEET Pag. 39-40



AKANE Pag. 41



GÉNESIS Pag. 42



MARIS Pag. 43



HALO Pag. 44



EDNA Pag. 44



SIGMA Pag. 44

DOWNLIGHTS DE ALIMENTACIÓN/ DOWNLIGHTS FOR FOOD/ DOWNLIGHTS POUR L'ALIMENTATION



KOBE Pag. 46

MINI DOWNLIGHTS DE SUPERFICIE/ SURFACE MINI DOWNLIGHTS/ MINI-DOWNLIGHTS DE SURFACE



LUA Pag. 48



ELIO Pag. 48



ALINA Pag. 48

DOWNLIGHTS DE SUPERFICIE/ SURFACE DOWNLIGHTS/ DOWNLIGHTS DE SURFACE



ELSA Pag. 50



ELLEN Pag. 51

ÍNDICE / INDEX / INDICE

DOWNLIGHTS DE SUSPENSIÓN/PENDANT LUMINAIRES / DOWNLIGHTS À SUSPENSION



ELLEN Pag. 53

LINEAR LIGHT



ORNA Pag. 55-59

LUMINARIAS DE ESCAYOLA/ PLASTER LUMINAIRES/LUMINAIRES EN PLÂTRE



LEK Pag. 61



KIAT Pag. 61



MANAT Pag. 61

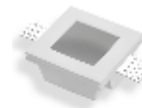

LEVA Pag. 62



RIEL Pag. 62



LITAS Pag. 62



RUBLO Pag. 62



WAT Pag. 63



YUAN Pag. 63



TAKA Pag. 63



DIRHAM Pag. 64



JAYER Pag. 64



DONG Pag. 64



LILAN Pag. 64



SUM Pag. 65



RAND Pag. 65



NARIA Pag. 65



LIBRA Pag. 65

LUMINARIAS DECORATIVAS/ DECORATIVE LUMINAIRES/ LUMINAIRES DÉCORATIFS



DENAR Pag. 67



LUMINARIAS DE CARRIL/ TRACK LUMINAIRES/LUMINAIRES SUR RAIL



ARIES Pag. 69



ORLI Pag. 70



CLOE Pag. 71



ANKO Pag. 72



ELLEN Pag. 73

ÍNDICE / INDEX / INDICE

TRACK SYSTEM



TRIFASICO Pag. 75



ACCESORIOS Pag. 75



TRIFASICO DALI Pag. 76



ACCESORIOS DALI Pag. 76

ILUMINACIÓN DE INTERIOR EMPOTRADA/ RECESSED INDOOR LIGHTING/ ÉCLAIRAGE INTÉRIEUR ENCASTRÉ



FENIX Pag. 78



ZIRCON Pag. 793



SAPPHIRE Pag. 79



YUE Pag. 80



AYLA Pag. 80

APLIQUES DE INTERIOR/ INDOOR APPLIANCES/ APPAREILS D'INTÉRIEUR



NELLA Pag. 82



AZAI Pag. 82



KERR Pag. 82



JULIA Pag. 83



RHODA Pag. 83



HELENA Pag. 84



KON Pag. 84



BENOR Pag. 84



NOGA Pag. 85



MEIRA Pag. 85



ELINA Pag. 85



ADHAR Pag. 86



NARA Pag. 86



KARNI Pag. 86



MAOR Pag. 87



JATA Pag. 87



DESA Pag. 87



ESTELA Pag. 89

LUMINARIAS LINEAL/ LINEAR LUMINAIRES/ LUMINAIRES LINÉAIRES



ZEBRA Pag. 89



SIMA Empotrar Pag. 90-97



SIMA Superficie Pag. 98-106



ACCESORIOS SIMA Pag. 107

ÍNDICE / INDEX / INDICE

LUMINARIAS DE EMPOTRAR - SUPERFICIE/ RECESSED SURFACE - LUMINAIRES /LUMINAIRES ENCASTRÉS - SURFACE



OMET Pag. 109



GALAXY Pag. 110



LYSSA Pag. 111-112



KIRA Pag. 113-114



KAREN Pag. 115



XENIA Pag. 116-119

LUMINARIAS SALAS LIMPIAS/ CLEAN ROOM LUMINAIRES/ LUMINAIRES POUR SALLES BLANCHES



DALAI Pag. 121



TELEM Pag. 122

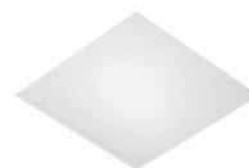

ANAVA Pag. 123

LUMINARIA PISABLE/ WALKABLE LUMINAIRE/ LUMINAIRE MARCHABLE



HESTER Pag. 124

LUMINARIAS VACIAS EMPTY LUMINAIRES LUMINAIRES VIDES



ORAN Pag. 125

MARCOS EMPOTRAR SUPERFICIE RECESSED SURFACE FRAMES CADRES ENCASTRÉS SURFACE



SITARA Pag. 126

LUMINARIA COLEGIOS LUMINAIRE SCHOOLS LUMINAIRE ÉCOLES



THEA Pag. 128

ILUMINACIÓN INDUSTRIAL/ INDUSTRIAL LIGHTING/ ÉCLAIRAGE INDUSTRIEL



ANUBIS Pag. 130



OREL Pag. 131

ÍNDICE / INDEX / INDICE

LUMINARIAS ESTANCAS/WATERPROOF LUMINAIRES/LUMINAIRES ÉTANCHES

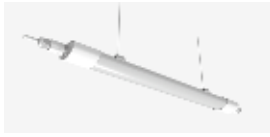

BELA Pag. 134



LYRA Pag. 134



HELIO Pag. 134

ATEX LUMINAIRES



LUMINARIA ESTANCA
ATEX Pag. 135



EMERGENCIA
ATEX Pag. 135

ILUMINACIÓN DEPORTIVAS Y GRANDES ÁREAS/SPORTS LIGHTING AND LARGE AREAS/ECLAIRAGE SPORTIF ET GRANDES SURFACES



APOLO Pag. 137



PEGASO Pag. 138



GOLDEN Pag. 140

ILUMINACIÓN VIAL/ROAD LIGHTING/ÉCLAIRAGE ROUTIER



ALEX Pag. 142



ADAMA Pag. 143



JARET Pag. 143



LIOR Pag. 144



GUIOR Pag. 144

COLUMNAS Y TORRES/COLUMNS AND TOWERS/COLONNES ET TOURS

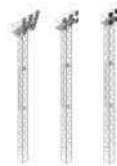

TORRES Pag. 146

ILUMINACIÓN EXTERIOR DE EMPOTRAR/OUTDOOR RECESSED LIGHTING/ÉCLAIRAGE ENCASTRÉ EXTÉRIEUR



URI Pag. 148



SHERA Pag. 148



INHAR Pag. 148



GULARA Pag. 149



SEREN Pag. 149



ADRIA Pag. 149



MARÍA Pag. 150



PILEA Pag. 150



ANDREA Pag. 151



COOPER Pag. 152



VERA Pag. 152



CIANA Pag. 153



HATRIA Pag. 153





ANAN Pag. 154

ÍNDICE / INDEX / INDICE

ILUMINACIÓN EXTERIOR DE SUPERFICIE/ OUTDOOR SURFACE LIGHTING/ ÉCLAIRAGE DE SURFACE EXTÉRIEUR

 ARNY Pag. 156	 MIGUEL Pag. 157	 ROY Pag. 157	 New HANA Pag. 157	 EDEN Pag. 158	 AKINA Pag. 158	 AINARA Pag. 158	 New ATOM Pag. 159	
 TRASSE Pag. 160	 MAYA Pag. 161	 VISIA Pag. 161	 New DIANA Pag. 161	 VEGA Pag. 162	 IRENE Pag. 162	 LINUS Pag. 162	 SYLAR Pag. 163	 RAUL Pag. 163
 DALIA Pag. 163	 NILS Pag. 164	 NEO Pag. 164	 OTTO Pag. 164	 MOA Pag. 165	 LEA Pag. 165	 GEA Pag. 165	 New KARINA Pag. 166	 ILAN Pag. 167
 ALBA Pag. 167	 LEXIE Pag. 168	 ARIA Pag. 168	 CARLOTA Pag. 168	 LEIA Pag. 169	 AGNES Pag. 169	 SIGAL Pag. 169	 VIGGO Pag. 169	

ILUMINACIÓN SUBACUÁTICA/ UNDERWATER LIGHTING/ ÉCLAIRAGE SOUS-MARIN

 CAIA Pag. 171	 ARALE Pag. 172	 INNA Pag. 173	 NAMI Pag. 173
--	---	---	--

ILUMINACIÓN DE BAÑO/BATHROOM LIGHTING/ ÉCLAIRAGE SALLE DE BAIN

 ALEIX Pag. 175	 NORAH Pag. 175	 SAHAR Pag. 176	 NOA Pag. 176	 AFRODITA Pag. 176	 VIOLETA Pag. 177	 ALTEA Pag. 177
--	---	---	---	---	---	---

ILUMINACIÓN DE EMERGENCIA/ EMERGENCY LIGHT/ LUMIÈRE D'URGENCE

 FOGO Pag. 178	 AMIRA Pag. 178	 POLARIS Pag. 178	 ASTIN Pag. 179	 ESSIE Pag. 179	 MANLEY Pag. 179	 SALMA Pag. 180	 TELMA Pag. 180
---	---	---	---	---	--	---	---

SISTEMAS DE CONTROL/CONTROL SYSTEMS/ SYSTÈMES DE CONTRÔLE

 REGULADOR INALÁMBRICO AC TRIAC Pag. 182	 TUYA INTERRUPTOR ON/OFF Pag. 182	 INTERRUPTOR INALÁMBRICO ON/OFF Pag. 182	 REGULADOR DALI 24V Pag. 183	 CONTROLADOR DALI A AC TRIAC Pag. 183	 REGULADOR 0/1 - 10V Pag. 184	 SMART DRIVER REGULABLE Pag. 185
--	---	--	--	--	---	--



LYOPRO
LEVEL



MINI DOWNLIGHTS DE EMPOTRAR
RECESSED MINI DOWNLIGHTS
MINI DOWNLIGHTS ENCASTRÉS

AGATE

bridgelux
LED CHIP

IP
20

UGR < 19



100-265V
50/60Hz

Alu

Acrylic
Cover



CE

3

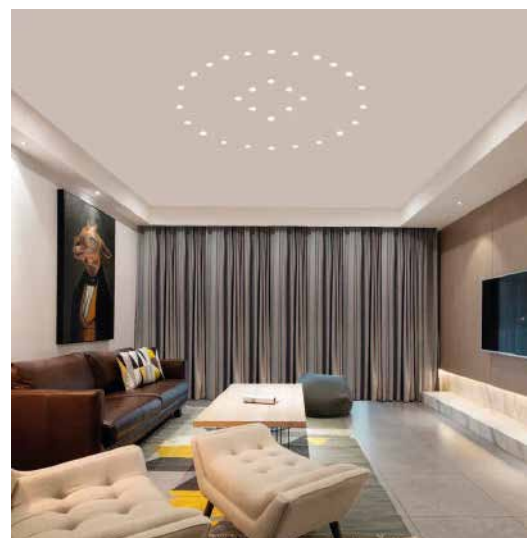
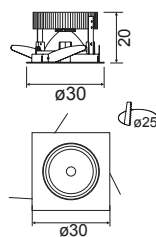
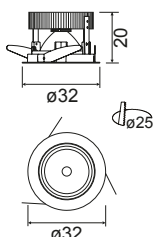

CÓDIGO	W	LM	K	VERSIÓN	ÓPTICA°	Ra/CRI			L	W	H	PVP	
60000	1w	95Lm	3000K	Redondo	30	>80	-20+50	B <input type="checkbox"/>	32		20	25	11,25€
60001	1w	100Lm	4000K	Redondo	30	>80	-20+50	B <input type="checkbox"/>	32		20	25	11,25€
60003	1w	95Lm	3000K	Cuadrado	30	>80	-20+50	B <input type="checkbox"/>	30	30	20	25	11,25€
60004	1w	100Lm	4000K	Cuadrado	30	>80	-20+50	B <input type="checkbox"/>	30	30	20	25	11,25€

ELIAN

CREE
LED CHIP

LED DRIVER

IP
20

UGR < 19



220-240V
50/60Hz

Alu

Acrylic
Cover



CE

3

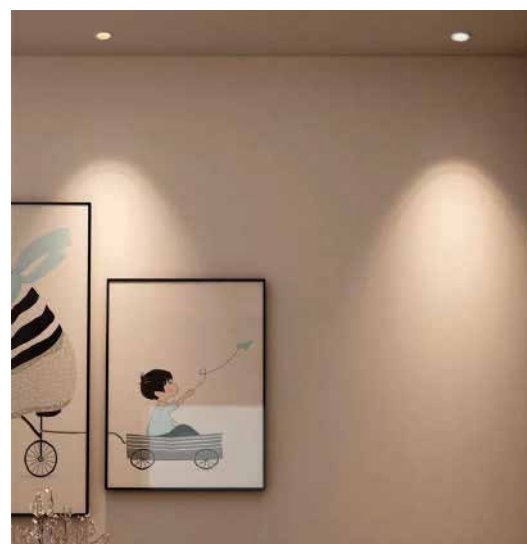
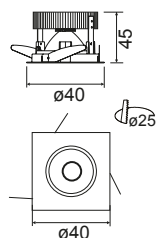
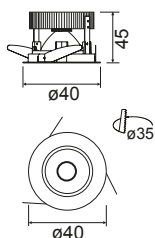

CÓDIGO	W	LM	K	VERSIÓN	ÓPTICA°	Ra/CRI			L	W	H	PVP	
60010	3w	285Lm	3000K	Redondo	30	>80	-20+50	B <input type="checkbox"/>	40		45	35	22,95€
60011	3w	300Lm	4000K	Redondo	30	>80	-20+50	B <input type="checkbox"/>	40		45	35	22,95€
60013	3w	285Lm	3000K	Cuadrado	30	>80	-20+50	B <input type="checkbox"/>	40	40	45	35	22,95€
60014	3w	300Lm	4000K	Cuadrado	30	>80	-20+50	B <input type="checkbox"/>	40	40	45	35	22,95€

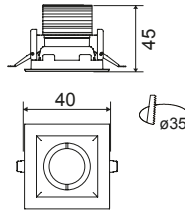
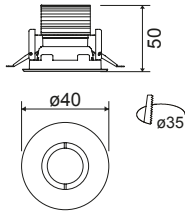

CÓDIGO	W	LM	K	VERSIÓN	ÓPTICA°	Ra/CRI			L	W	H	PVP	
60015	3w	270Lm	2700K	Redondo	30	>80	-20+50	B <input type="checkbox"/>	40		50	35	24,95€
60016	3w	285Lm	3000K	Redondo	30	>80	-20+50	B <input type="checkbox"/>	40		50	35	24,95€
60017	3w	300Lm	4000K	Redondo	30	>80	-20+50	B <input type="checkbox"/>	40		50	35	24,95€
60019	3w	285Lm	3000K	Cuadrado	30	>80	-20+50	B <input type="checkbox"/>	40	40	45	35	24,95€
60020	3w	300Lm	4000K	Cuadrado	30	>80	-20+50	B <input type="checkbox"/>	40	40	45	35	24,95€
60021	3w	270Lm	2700K	Redondo	30	>80	-20+50	N <input checked="" type="checkbox"/>	40		50	35	26,95€
60022	3w	285Lm	3000K	Redondo	30	>80	-20+50	N <input checked="" type="checkbox"/>	40		50	35	26,95€
60023	3w	300Lm	4000K	Redondo	30	>80	-20+50	N <input checked="" type="checkbox"/>	40		50	35	26,95€



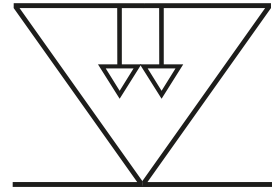

LYOPRO
LEVEL



LISA

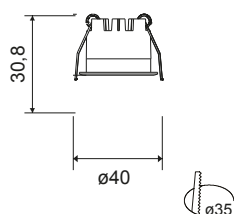

CÓDIGO	W	LM	K	VERSIÓN	ÓPTICA°			L		W	H		PVP
60400	3w	270Lm	2700K	R Redondo	15	B	-20+50	40		30,8	35		24,95€
60401	3w	285Lm	3000K		25	N	-20+50	40		30,8	35		24,95€
60402	3w	300Lm	4000K		50	BN	-20+50	40		30,8	35		24,95€
						NB							



LYOPRO
LEVEL

DOWNLIGHTS EMPOTRAR
RECESSED DOWNLIGHTS
DOWNLIGHTS ENCASTRÉS



LYOPRO
LEVEL



SIRA



SIRA

CREE
LED CHIP

LiFud
LED Driver

UGR < 19



220V-240V
50/60Hz

Alu
PC

EM

Cri>90



CE

3

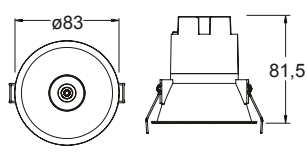

R

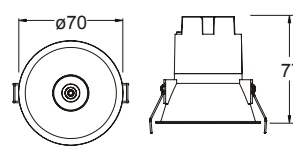

R65



Available in October 23

CÓDIGO	W	LM	K	IP	VERSIÓN	ÓPTICA°		ELECTRÓNICA	PVP (R)	PVP (R65)
60299	5w	450Lm	2700K	IP20	<u>R</u> Redondo	<u>15</u>	<u>B</u>	<u>SR</u> ON/OFF	25,75€	24,95€
60300	5w	475Lm	3000K		<u>R65</u> Redondo	<u>24</u>	<u>N</u>	<u>A</u> TRIAC	41,95€	39,95€
60301	5w	500Lm	4000K			<u>38</u>	<u>BR</u>	<u>B</u> 1-10V	51,95€	49,95€
							<u>BO</u>	<u>C</u> DALI/PUSH	61,95€	59,95€
							<u>BPM</u>			
							<u>BN</u>			

CÓDIGO	W	LM	K	IP	VERSIÓN	ÓPTICA°		ELECTRÓNICA	PVP (R)	PVP (R65)
60299	5w	450Lm	2700K	<u>IP65</u>	<u>R</u> Redondo	<u>15</u>	<u>B</u>	<u>SR</u> ON/OFF	32,75€	31,95€
60300	5w	475Lm	3000K		<u>R65</u> Redondo	<u>24</u>	<u>N</u>	<u>A</u> TRIAC	48,95€	46,95€
60301	5w	500Lm	4000K			<u>38</u>	<u>BR</u>	<u>B</u> 1-10V	58,95€	56,95€
							<u>BO</u>	<u>C</u> DALI/PUSH	68,95€	66,95€
							<u>BPM</u>			
							<u>BN</u>			



Available in November 23

SIRA

CREE
LED CHIP

LiFud
LED Driver

UGR < 19



220V-240V
50/60Hz

Alu
PC

EM

Cri>90



CE

3

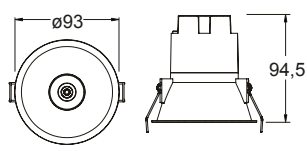

R

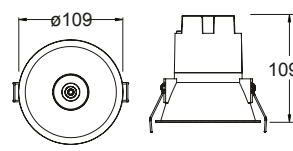

R100



Available in October 23

CÓDIGO	W	LM	K	IP	VERSIÓN	ÓPTICA°		ELECTRÓNICA	PVP (R)	PVP (R100)
60302	10w	900Lm	2700K	IP20	<u>R</u> Redondo	<u>15</u>	<u>B</u>	<u>SR</u> ON/OFF	34,30€	38,95€
60303	10w	950Lm	3000K		<u>R100</u> Redondo	<u>24</u>	<u>N</u>	<u>A</u> TRIAC	49,95€	52,95€
60304	10w	1000Lm	4000K			<u>38</u>	<u>BR</u>	<u>B</u> 1-10V	59,95€	62,95€
							<u>BO</u>	<u>C</u> DALI/PUSH	69,95€	72,95€
							<u>BPM</u>			
							<u>BN</u>			

CÓDIGO	W	LM	K	IP	VERSIÓN	ÓPTICA°		ELECTRÓNICA	PVP (R)	PVP (R100)
60302	10w	900Lm	2700K	<u>IP65</u>	<u>R</u> Redondo	<u>15</u>	<u>B</u>	<u>SR</u> ON/OFF	42,95€	48,95€
60303	10w	950Lm	3000K		<u>R100</u> Redondo	<u>24</u>	<u>N</u>	<u>A</u> TRIAC	58,95€	62,95€
60304	10w	1000Lm	4000K			<u>38</u>	<u>BR</u>	<u>B</u> 1-10V	68,95€	72,95€
							<u>BO</u>	<u>C</u> DALI/PUSH	78,95€	82,95€
							<u>BPM</u>			
							<u>BN</u>			



Available in November 23

SIRA**CREE**
LED CHIP**LiFuD**
LED Driver

UGR < 19

220V-240V
50/60HzAlu
PC

EM

Cri>90



CE

3

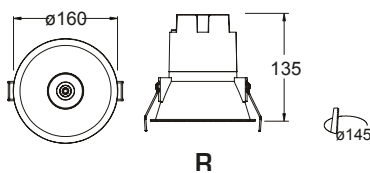
**R**

Available in November 23

CÓDIGO	W	LM	K	IP	VERSIÓN	ÓPTICA°		ELECTRÓNICA	PVP
64299	20w	1800Lm	2700K	IP20	<u>R</u> Redondo	<u>15</u>	B <input type="checkbox"/>	<u>SR</u> ON/OFF	49,95€
64300	20w	1900Lm	3000K			<u>24</u>	N <input checked="" type="checkbox"/>	<u>A</u> TRIAC	64,95€
64301	20w	2000Lm	4000K			<u>38</u>	BR <input checked="" type="checkbox"/>	<u>B</u> 1-10V	74,95€
							BO <input checked="" type="checkbox"/>	<u>C</u> DALI/PUSH	84,95€
							BPM <input checked="" type="checkbox"/>		
							BN <input checked="" type="checkbox"/>		

CÓDIGO	W	LM	K	IP	VERSIÓN	ÓPTICA°		ELECTRÓNICA	PVP
64299	20w	1800Lm	2700K	<u>I</u> IP65	<u>R</u> Redondo	<u>15</u>	B <input type="checkbox"/>	<u>SR</u> ON/OFF	62,95€
64300	20w	1900Lm	3000K			<u>24</u>	N <input checked="" type="checkbox"/>	<u>A</u> TRIAC	77,95€
64301	20w	2000Lm	4000K			<u>38</u>	BR <input checked="" type="checkbox"/>	<u>B</u> 1-10V	87,95€
							BO <input checked="" type="checkbox"/>	<u>C</u> DALI/PUSH	97,95€
							BPM <input checked="" type="checkbox"/>		
							BN <input checked="" type="checkbox"/>		

SIRA**CREE**
LED CHIP**LiFuD**
LED Driver

UGR < 19

220V-240V
50/60HzAlu
PC

EM

Cri>90



CE

3

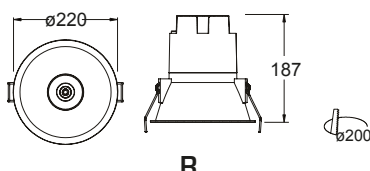
**R**

Available in November 23

CÓDIGO	W	LM	K	IP	VERSIÓN	ÓPTICA°		ELECTRÓNICA	PVP
64302	30w	2700Lm	2700K	IP20	<u>R</u> Redondo	<u>15</u>	B <input type="checkbox"/>	<u>SR</u> ON/OFF	64,95€
64303	30w	2850Lm	3000K			<u>24</u>	N <input checked="" type="checkbox"/>	<u>A</u> TRIAC	79,95€
64304	30w	3000Lm	4000K			<u>38</u>	BR <input checked="" type="checkbox"/>	<u>B</u> 1-10V	89,95€
							BO <input checked="" type="checkbox"/>	<u>C</u> DALI/PUSH	99,95€
							BPM <input checked="" type="checkbox"/>		
							BN <input checked="" type="checkbox"/>		

CÓDIGO	W	LM	K	IP	VERSIÓN	ÓPTICA°		ELECTRÓNICA	PVP
64302	30w	2700Lm	2700K	<u>I</u> IP65	<u>R</u> Redondo	<u>15</u>	B <input type="checkbox"/>	<u>SR</u> ON/OFF	80,95€
64303	30w	2850Lm	3000K			<u>24</u>	N <input checked="" type="checkbox"/>	<u>A</u> TRIAC	95,95€
64304	30w	3000Lm	4000K			<u>38</u>	BR <input checked="" type="checkbox"/>	<u>B</u> 1-10V	105,95€
							BO <input checked="" type="checkbox"/>	<u>C</u> DALI/PUSH	115,95€
							BPM <input checked="" type="checkbox"/>		
							BN <input checked="" type="checkbox"/>		

SIRA

CREE LED CHIP

LIFUD LED Driver

UGR < 19



220V-240V
50/60Hz

Alu PC

EM

Cri>90

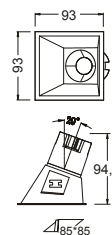
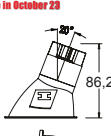
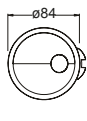
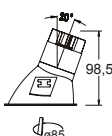
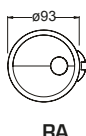

CA

CÓDIGO	W	LM	K	IP	VERSIÓN	ÓPTICA°		ELECTRÓNICA	PVP (RA-CA)	PVP (RA75)
60299	5w	450Lm	2700K	IP20	<u>RA</u> Redondo Asim.	<u>15</u>	<u>B</u> <input type="checkbox"/>	<u>SR</u> ON/OFF	26,85€	25,95€
60300	5w	475Lm	3000K		<u>RA75</u> Redondo Asim.	<u>24</u>	<u>N</u> <input type="checkbox"/>	<u>A</u> TRIAC	43,95€	42,95€
60301	5w	500Lm	4000K		<u>CA</u> Cuadrado Asim.	<u>38</u>	<u>BR</u> <input type="checkbox"/>	<u>B</u> 1-10V	53,95€	52,95€
							<u>BO</u> <input type="checkbox"/>	<u>C</u> DALI/PUSH	63,95€	62,95€
							<u>BPM</u> <input type="checkbox"/>			
							<u>BN</u> <input type="checkbox"/>			

CÓDIGO	W	LM	K	IP	VERSIÓN	ÓPTICA°		ELECTRÓNICA	PVP (RA-CA)	PVP (RA75)
60299	5w	450Lm	2700K	<u>I</u> IP65	<u>RA</u> Redondo Asim.	<u>15</u>	<u>B</u> <input type="checkbox"/>	<u>SR</u> ON/OFF	33,85€	32,95€
60300	5w	475Lm	3000K		<u>RA75</u> Redondo Asim.	<u>24</u>	<u>N</u> <input type="checkbox"/>	<u>A</u> TRIAC	50,95€	49,95€
60301	5w	500Lm	4000K	<u>IP</u> 65	<u>CA</u> Cuadrado Asim.	<u>38</u>	<u>BR</u> <input type="checkbox"/>	<u>B</u> 1-10V	60,95€	59,95€
							<u>BO</u> <input type="checkbox"/>	<u>C</u> DALI/PUSH	70,95€	69,95€
							<u>BPM</u> <input type="checkbox"/>			
							<u>BN</u> <input type="checkbox"/>			

SIRA

CREE LED CHIP

LIFUD LED Driver

UGR < 19



220V-240V
50/60Hz

Alu PC

EM

Cri>90

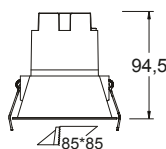
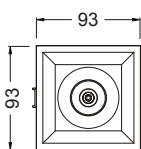

CÓDIGO	W	LM	K	IP	VERSIÓN	ÓPTICA°		ELECTRÓNICA	PVP
60302	10w	900Lm	2700K	IP20	<u>C</u> Cuadrado	<u>15</u>	<u>B</u> <input type="checkbox"/>	<u>SR</u> ON/OFF	34,30€
60303	10w	950Lm	3000K			<u>24</u>	<u>N</u> <input type="checkbox"/>	<u>A</u> TRIAC	49,95€
60304	10w	1000Lm	4000K			<u>38</u>	<u>BR</u> <input type="checkbox"/>	<u>B</u> 1-10V	59,95€
							<u>BO</u> <input type="checkbox"/>	<u>C</u> DALI/PUSH	69,95€
							<u>BPM</u> <input type="checkbox"/>		
							<u>BN</u> <input type="checkbox"/>		

CÓDIGO	W	LM	K	IP	VERSIÓN	ÓPTICA°		ELECTRÓNICA	PVP
60302	10w	900Lm	2700K	<u>I</u> IP65	<u>C</u> Cuadrado	<u>15</u>	<u>B</u> <input type="checkbox"/>	<u>SR</u> ON/OFF	42,95€
60303	10w	950Lm	3000K			<u>24</u>	<u>N</u> <input type="checkbox"/>	<u>A</u> TRIAC	58,95€
60304	10w	1000Lm	4000K	<u>IP</u> 65		<u>38</u>	<u>BR</u> <input type="checkbox"/>	<u>B</u> 1-10V	68,95€
							<u>BO</u> <input type="checkbox"/>	<u>C</u> DALI/PUSH	78,95€
							<u>BPM</u> <input type="checkbox"/>		
							<u>BN</u> <input type="checkbox"/>		

SIRA

CREE
LED CHIP

LIFUD
LED Driver

UGR < 19



220V-240V
50/60Hz

Alu
PC

EM

Cri>90



CE

3



TRIMLESS

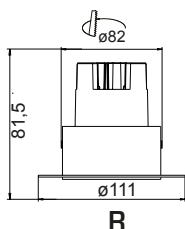

R

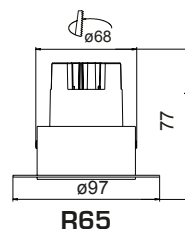
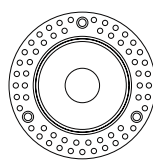
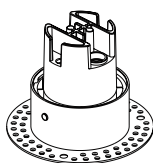

R65



Available in November 23

CÓDIGO	W	LM	K	IP	INSTALACIÓN	VERSIÓN	ÓPTICA°		ELECTRÓNICA	PVP (R)	PVP (RA65)
60299	5w	450Lm	2700K	IP20	T Trimless	R Redondo	15	B <input type="checkbox"/>	SR ON/OFF	36,75€	34,95€
60300	5w	475Lm	3000K			R65 Redondo	24	N <input type="checkbox"/>	A TRIAC	52,95€	49,95€
60301	5w	500Lm	4000K				38	BR <input type="checkbox"/>	B 1-10V	62,95€	59,95€
								BO <input type="checkbox"/>	C DALI/PUSH	72,95€	69,95€
								BPM <input type="checkbox"/>			
								BN <input type="checkbox"/>			

CÓDIGO	W	LM	K	IP	INSTALACIÓN	VERSIÓN	ÓPTICA°		ELECTRÓNICA	PVP (R)	PVP (RA65)
60299	5w	450Lm	2700K	IP65	T Trimless	R Redondo	15	B <input type="checkbox"/>	SR ON/OFF	45,75€	43,95€
60300	5w	475Lm	3000K			R65 Redondo	24	N <input type="checkbox"/>	A TRIAC	61,95€	58,95€
60301	5w	500Lm	4000K				38	BR <input type="checkbox"/>	B 1-10V	71,95€	68,95€
								BO <input type="checkbox"/>	C DALI/PUSH	81,95€	78,95€
								BPM <input type="checkbox"/>			
								BN <input type="checkbox"/>			

SIRA

CREE
LED CHIP

LIFUD
LED Driver

UGR < 19



220V-240V
50/60Hz

Alu
PC

EM

Cri>90



CE

3



TRIMLESS

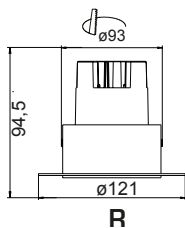

R

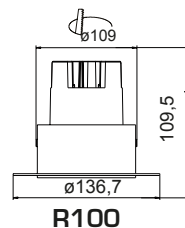
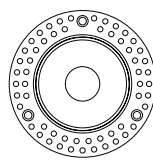
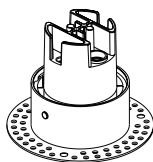

R100



Available in November 23

CÓDIGO	W	LM	K	IP	INSTALACIÓN	VERSIÓN	ÓPTICA°		ELECTRÓNICA	PVP (R)	PVP (R100)
60302	10w	900Lm	2700K	IP20	T Trimless	R Redondo	15	B <input type="checkbox"/>	SR ON/OFF	46,30€	52,95€
60303	10w	950Lm	3000K			R100 Redondo	24	N <input type="checkbox"/>	A TRIAC	61,95€	66,95€
60304	10w	1000Lm	4000K				38	BR <input type="checkbox"/>	B 1-10V	71,95€	76,95€
								BO <input type="checkbox"/>	C DALI/PUSH	81,95€	86,95€
								BPM <input type="checkbox"/>			
								BN <input type="checkbox"/>			

CÓDIGO	W	LM	K	IP	INSTALACIÓN	VERSIÓN	ÓPTICA°		ELECTRÓNICA	PVP (R)	PVP (R100)
60302	10w	900Lm	2700K	IP65	T Trimless	R Redondo	15	B <input type="checkbox"/>	SR ON/OFF	56,95€	65,95€
60303	10w	950Lm	3000K			R100 Redondo	24	N <input type="checkbox"/>	A TRIAC	71,95€	79,95€
60304	10w	1000Lm	4000K				38	BR <input type="checkbox"/>	B 1-10V	81,95€	89,95€
								BO <input type="checkbox"/>	C DALI/PUSH	91,95€	99,95€
								BPM <input type="checkbox"/>			
								BN <input type="checkbox"/>			

SIRA**CREE**
LED CHIP**LIFUD**
LED Driver

UGR < 19

220V-240V
50/60HzAlu
PC

EM

Cri>90



CE

3



TRIMLESS

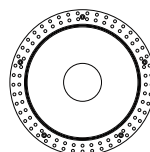
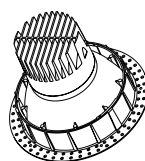
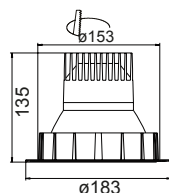

Available in November 23

CÓDIGO	W	LM	K	IP	INSTALACIÓN	VERSIÓN	ÓPTICA°		ELECTRÓNICA	PVP (R)
64299	20w	1800Lm	2700K	IP20	<u>T</u> Trimless	<u>R</u> Redondo	<u>15</u>	<u>B</u>	<u>SR</u> ON/OFF	69,95€
64300	20w	1900Lm	3000K				<u>24</u>	<u>N</u>	<u>A</u> TRIAC	94,95€
64301	20w	2000Lm	4000K				<u>38</u>	<u>BR</u>	<u>B</u> 1-10V	104,95€
								<u>BO</u>	<u>C</u> DALI/PUSH	114,95€
								<u>BPM</u>		
								<u>BN</u>		

CÓDIGO	W	LM	K	IP	INSTALACIÓN	VERSIÓN	ÓPTICA°		ELECTRÓNICA	PVP (R)
64299	20w	1800Lm	2700K	<u>I</u> IP65	<u>T</u> Trimless	<u>R</u> Redondo	<u>15</u>	<u>B</u>	<u>SR</u> ON/OFF	84,95€
64300	20w	1900Lm	3000K				<u>24</u>	<u>N</u>	<u>A</u> TRIAC	109,95€
64301	20w	2000Lm	4000K				<u>38</u>	<u>BR</u>	<u>B</u> 1-10V	119,95€
								<u>BO</u>	<u>C</u> DALI/PUSH	129,95€
								<u>BPM</u>		
								<u>BN</u>		

SIRA**CREE**
LED CHIP**LIFUD**
LED Driver

UGR < 19

220V-240V
50/60HzAlu
PC

EM

Cri>90



CE

3



TRIMLESS

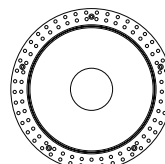
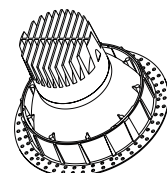
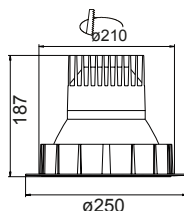

Available in November 23

CÓDIGO	W	LM	K	IP	INSTALACIÓN	VERSIÓN	ÓPTICA°		ELECTRÓNICA	PVP
64302	30w	2700Lm	2700K	IP20	<u>T</u> Trimless	<u>R</u> Redondo	<u>15</u>	<u>B</u>	<u>SR</u> ON/OFF	89,95€
64303	30w	2850Lm	3000K				<u>24</u>	<u>N</u>	<u>A</u> TRIAC	104,95€
64304	30w	3000Lm	4000K				<u>38</u>	<u>BR</u>	<u>B</u> 1-10V	114,95€
								<u>BO</u>	<u>C</u> DALI/PUSH	124,95€
								<u>BPM</u>		
								<u>BN</u>		

CÓDIGO	W	LM	K	IP	INSTALACIÓN	VERSIÓN	ÓPTICA°		ELECTRÓNICA	PVP
64302	30w	2700Lm	2700K	<u>I</u> IP65	<u>T</u> Trimless	<u>R</u> Redondo	<u>15</u>	<u>B</u>	<u>SR</u> ON/OFF	109,95€
64303	30w	2850Lm	3000K				<u>24</u>	<u>N</u>	<u>A</u> TRIAC	124,95€
64304	30w	3000Lm	4000K				<u>38</u>	<u>BR</u>	<u>B</u> 1-10V	134,95€
								<u>BO</u>	<u>C</u> DALI/PUSH	144,95€
								<u>BPM</u>		
								<u>BN</u>		

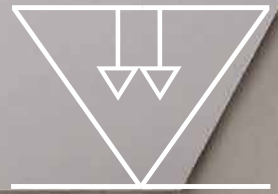

LYOPRO
LEVEL



LUNA

IP65
Waterproof grade

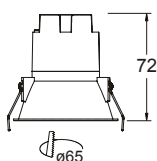
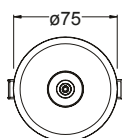

CÓDIGO	W	LM	K	VERSIÓN	ÓPTICA°		ELECTRÓNICA	PVP
60560	8w	720Lm	2700K	Redondo	35	B	SR ON/OFF	69,95€
60561	8w	760Lm	3000K		55	N	A TRIAC	84,95€
60562	8w	800Lm	4000K				B 1-10V	89,95€
							C DALI/PUSH	99,95€

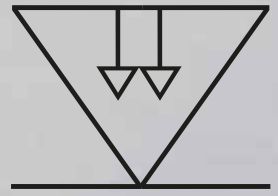

LYOPRO
LEVEL



DELIA



2700 - 3000 - 4000K



Available in November 23

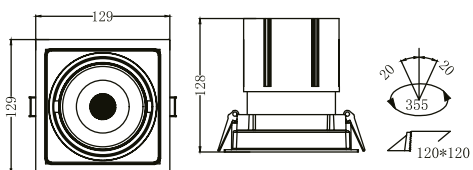
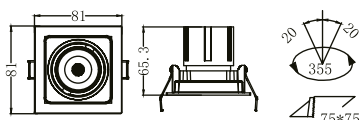
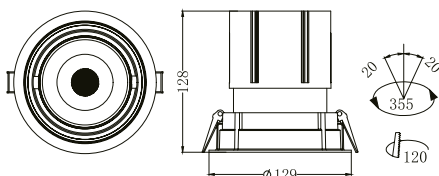
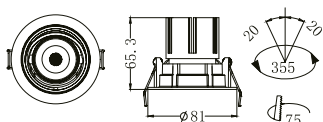

CÓDIGO	W	LM	K		VERSIÓN	ÓPTICA°		ELECTRÓNICA	PVP
62710	7w	700Lm	3 CCT	-20+50	R Redondo	<u>15</u>	B <input type="checkbox"/>	SR ON/OFF	46,95€
					C Cuadrado	<u>24</u>	N <input type="checkbox"/>	A TRIAC	59,95€
						<u>36</u>	BN <input type="checkbox"/>	B 1-10V	62,95€
							NB <input type="checkbox"/>	C DALI/PUSH	76,95€

CÓDIGO	W	LM	K		VERSIÓN	ÓPTICA°		ELECTRÓNICA	PVP
62713	30w	3000Lm	3 CCT	-20+50	R Redondo	<u>15</u>	B <input type="checkbox"/>	SR ON/OFF	99,95€
					C Cuadrado	<u>24</u>	N <input type="checkbox"/>	A TRIAC	114,95€
						<u>36</u>	BN <input type="checkbox"/>	B 1-10V	119,95€
							NB <input type="checkbox"/>	C DALI/ PUSH	138,95€

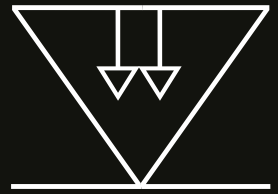

LYOPRO
LEVEL



ZORA

ZORA

CREE
LED CHIP

AGT
LED DRIVER

IP
44

UGR < 19



220V-240V
50/60Hz

Alu

EM



CE

5



2700 - 3000 - 4000K

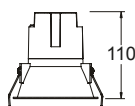
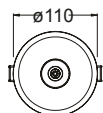

∅100



CÓDIGO	W	LM	K	Ra/CRI		IP		ÓPTICA°	ELECTRÓNICA	PVP
60370	20w	1560Lm	3000K	>90	-20+50	44	B <input type="checkbox"/>	15	SR ON/OFF	79,95€
60371	20w	1600Lm	4000K	>90	-20+50		BO <input checked="" type="checkbox"/>	24	A TRIAC	99,95€
60360	20w	1600Lm	3 CCT	>90	-20+50		BN <input checked="" type="checkbox"/>	38	B 1-10V	104,95€
							BPB <input type="checkbox"/>		C DALI/ PUSH	119,95€
							BPM <input type="checkbox"/>			

ZORA

CREE
LED CHIP

AGT
LED DRIVER

IP
44

UGR < 19



220V-240V
50/60Hz

Alu

EM



CE

5



2700 - 3000 - 4000K

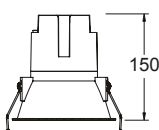
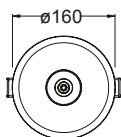

∅150



CÓDIGO	W	LM	K	Ra/CRI		IP		ÓPTICA°	ELECTRÓNICA	PVP
60373	40w	3120Lm	3000K	>90	-20+50	44	B <input type="checkbox"/>	15	SR ON/OFF	129,95€
60374	40w	3200Lm	4000K	>90	-20+50		BO <input checked="" type="checkbox"/>	24	A TRIAC	149,95€
60363	40w	3200Lm	3 CCT	>90	-20+50		BN <input checked="" type="checkbox"/>	38	B 1-10V	159,95€
							BPB <input type="checkbox"/>		C DALI/ PUSH	169,95€
							BPM <input type="checkbox"/>			

ZORA

CREE
LED CHIP

AGT
LED DRIVER

IP
44

UGR < 10



220V-240V
50/60Hz

Alu



CE

5



2700 - 3000 - 4000K



Available in November 23

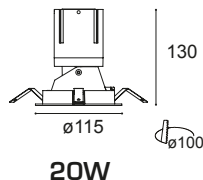

20W



CÓDIGO	W	LM	K	Ra/CRI	TEMP	VERSIÓN	ÓPTICA	ELECTRÓNICA	PVP	
60360	20W	1600Lm	3 CCT	>90	-20+50	<u>A</u>	<u>B</u> <input type="checkbox"/> <u>BO</u> <input checked="" type="checkbox"/> <u>BNB</u> <input checked="" type="checkbox"/> <u>BPB</u> <input checked="" type="checkbox"/> <u>BPM</u> <input checked="" type="checkbox"/>	<u>15</u> <u>24</u> <u>38</u> <u>B</u> <u>C</u>	<u>SR</u> ON/OFF <u>A</u> TRIAC <u>B</u> 1-10V <u>C</u> DALI/ PUSH	82,95€ 102,95€ 107,95€ 117,95€

ZORA

CREE
LED CHIP

AGT
LED DRIVER

IP
44

UGR < 10



220V-240V
50/60Hz

Alu



CE

5



2700 - 3000 - 4000K



Available in November 23

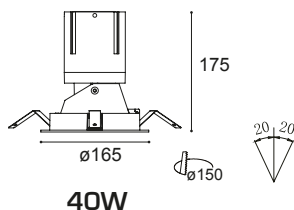

40W



CÓDIGO	W	LM	K	Ra/CRI	TEMP	VERSIÓN	ÓPTICA	ELECTRÓNICA	PVP	
60363	40W	3200Lm	3 CCT	>90	-20+50	<u>A</u>	<u>B</u> <input type="checkbox"/> <u>BO</u> <input checked="" type="checkbox"/> <u>BNB</u> <input checked="" type="checkbox"/> <u>BPB</u> <input checked="" type="checkbox"/> <u>BPM</u> <input checked="" type="checkbox"/>	<u>15</u> <u>24</u> <u>38</u> <u>B</u> <u>C</u>	<u>SR</u> ON/OFF <u>A</u> TRIAC <u>B</u> 1-10V <u>C</u> DALI/ PUSH	134,95€ 159,95€ 169,95€ 179,95€

ZORA

CREE
LED CHIP

AGT
LED DRIVER

IP
44

UGR < 10



220V-240V
50/60Hz

Alu

EM



CE

5



2700 - 3000 - 4000K



Available in November 23

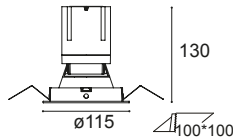

20W



CÓDIGO	W	LM	K	Ra/CRI		VERSIÓN		ÓPTICA°	ELECTRÓNICA	PVP
60360	20W	1600Lm	3 CCT	>90	-20+50	<u>B</u>	<u>B</u> <input type="checkbox"/> <u>BO</u> <input type="checkbox"/> <u>BNB</u> <input type="checkbox"/> <u>BPB</u> <input type="checkbox"/> <u>BPM</u> <input type="checkbox"/>	<u>15</u> <u>24</u> <u>38</u>	<u>SR</u> ON/OFF <u>A</u> TRIAC <u>B</u> 1-10V <u>C</u> DALI/ PUSH	84,95€ 104,95€ 109,95€ 119,95€

ZORA

CREE
LED CHIP

AGT
LED DRIVER

IP
44

UGR < 10



220V-240V
50/60Hz

Alu

EM



CE

5



2700 - 3000 - 4000K



Available in November 23

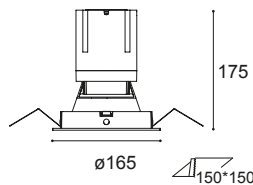

40W



CÓDIGO	W	LM	K	Ra/CRI		VERSIÓN		ÓPTICA°	ELECTRÓNICA	PVP
60363	40W	3200Lm	3 CCT	>90	-20+50	<u>B</u>	<u>B</u> <input type="checkbox"/> <u>BO</u> <input type="checkbox"/> <u>BNB</u> <input type="checkbox"/> <u>BPB</u> <input type="checkbox"/> <u>BPM</u> <input type="checkbox"/>	<u>15</u> <u>24</u> <u>38</u>	<u>SR</u> ON/OFF <u>A</u> TRIAC <u>B</u> 1-10V <u>C</u> DALI/ PUSH	138,95€ 164,95€ 174,95€ 184,95€

ZORA

CREE
LED CHIP

AGT
LED DRIVER

IP
44

UGR < 10



220V-240V
50/60Hz

Alu



CE

5



2700 - 3000 - 4000K



Available in November 23

TRIMLESS

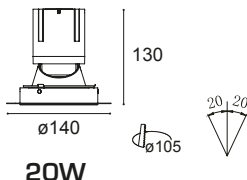

20W



CÓDIGO	W	LM	K	Ra/CRI	TEMP	VERSIÓN	OPT	ÓPTICA°	ELECTRÓNICA	PVP
60360	20W	1600lm	3 CCT	>90	-20+50	<u>C</u>	B <input type="checkbox"/> BO <input checked="" type="checkbox"/> BNB <input checked="" type="checkbox"/> BPB <input checked="" type="checkbox"/> BPM <input checked="" type="checkbox"/>	<u>15</u> <u>24</u> <u>38</u>	<u>SR</u> ON/OFF <u>A</u> TRIAC <u>B</u> 1-10V <u>C</u> DALI/ PUSH	85,95€ 105,95€ 110,95€ 120,95€

ZORA

CREE
LED CHIP

AGT
LED DRIVER

IP
44

UGR < 10



220V-240V
50/60Hz

Alu



CE

5



2700 - 3000 - 4000K



Available in November 23

TRIMLESS

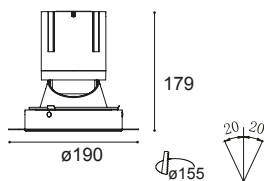

40W



CÓDIGO	W	LM	K	Ra/CRI	TEMP	VERSIÓN	OPT	ÓPTICA°	ELECTRÓNICA	PVP
60363	40W	3200lm	3 CCT	>90	-20+50	<u>C</u>	B <input type="checkbox"/> BO <input checked="" type="checkbox"/> BNB <input checked="" type="checkbox"/> BPB <input checked="" type="checkbox"/> BPM <input checked="" type="checkbox"/>	<u>15</u> <u>24</u> <u>38</u>	<u>SR</u> ON/OFF <u>A</u> TRIAC <u>B</u> 1-10V <u>C</u> DALI/ PUSH	140,95€ 166,95€ 176,95€ 186,95€

ZORA

CREE
LED CHIP

AGT
LED DRIVER

IP
44

UGR < 10



220V-240V
50/60Hz

Alu



CE

5



2700 - 3000 - 4000K



Available in November 23

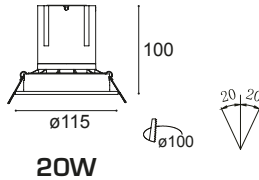

CÓDIGO	W	LM	K	Ra/CRI		VERSIÓN		ÓPTICA°	ELECTRÓNICA	PVP
60360	20W	1600Lm	3 CCT	>90	-20+50	<u>D</u>	B <input type="checkbox"/> BO <input checked="" type="checkbox"/> BN <input checked="" type="checkbox"/> BPB <input checked="" type="checkbox"/> BPM <input checked="" type="checkbox"/>	<u>15</u> <u>24</u> <u>38</u>	<u>SR</u> ON/OFF <u>A</u> TRIAC <u>B</u> 1-10V <u>C</u> DALI/ PUSH	82,95€ 101,95€ 106,95€ 121,95€

ZORA

CREE
LED CHIP

AGT
LED DRIVER

IP
44

UGR < 10



220V-240V
50/60Hz

Alu



CE

5



2700 - 3000 - 4000K



Available in November 23

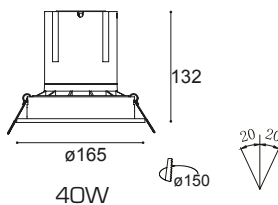

CÓDIGO	W	LM	K	Ra/CRI		VERSIÓN		ÓPTICA°	ELECTRÓNICA	PVP
60363	40W	3200Lm	3 CCT	>90	-20+50	<u>D</u>	B <input type="checkbox"/> BO <input checked="" type="checkbox"/> BN <input checked="" type="checkbox"/> BPB <input checked="" type="checkbox"/> BPM <input checked="" type="checkbox"/>	<u>15</u> <u>24</u> <u>38</u>	<u>SR</u> ON/OFF <u>A</u> TRIAC <u>B</u> 1-10V <u>C</u> DALI/ PUSH	131,95€ 151,95€ 161,95€ 171,95€



LYOPRO
LEVEL



0 1 2 3
mm



DEO

DEO**CREE**
LED CHIP**LiFUD**
LED DriverIP
20

UGR < 19

220-245V
50/60Hz

Alu

PC Opal
Difusor

EM

Cri>90



CE

3



2700 - 3000 - 4000K



Available in November 23

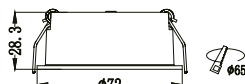

CÓDIGO	W	LM	K	EXTERIOR		Ra/CRI	INTERIOR		ELECTRÓNICA	PVP
				ÓPTICA°	Paleta		Paleta	Paleta		
62952	9w	900Lm	3 CCT	<u>B</u> <input type="checkbox"/>	<u>18</u>	>90	<u>B</u> <input type="checkbox"/>	<u>SR</u>	ON/OFF	26,95€
62953	9w	900Lm	3 CCT	<u>N</u> <input checked="" type="checkbox"/>	<u>24</u>	>90	<u>N</u> <input checked="" type="checkbox"/>	<u>A</u>	TRIAC	42,95€
					<u>36</u>			<u>B</u>	1-10V	44,95€
					<u>60</u>			<u>C</u>	DALI/ PUSH	64,95€

DEO**CREE**
LED CHIP**LiFUD**
LED DriverIP
20

UGR < 19

220-245V
50/60Hz

Alu

PC Opal
Difusor

EM

Cri>90



CE

3



2700 - 3000 - 4000K



Available in November 23

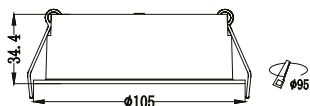

CÓDIGO	W	LM	K	EXTERIOR		Ra/CRI	INTERIOR		ELECTRÓNICA	PVP
				ÓPTICA°	Paleta		Paleta	Paleta		
62956	15w	1500Lm	3 CCT	<u>B</u> <input type="checkbox"/>	<u>18</u>	>90	<u>B</u> <input type="checkbox"/>	<u>SR</u>	ON/OFF	39,95€
62957	15w	1500Lm	3 CCT	<u>N</u> <input checked="" type="checkbox"/>	<u>24</u>	>90	<u>N</u> <input checked="" type="checkbox"/>	<u>A</u>	TRIAC	59,95€
					<u>36</u>			<u>B</u>	1-10V	62,95€
					<u>60</u>			<u>C</u>	DALI/ PUSH	79,95€



CÓDIGO	W	LM	K	ÓPTICA°	Ra/CRI	°C	Color	L H		ELECTRÓNICA	PVP	
								L	H			
60100	10w	850Lm	3000K	100	>>90	-20+50	B □	103	40	98	ON/OFF	32,95€
60100A	10w	850Lm	3000K	100	>90	-20+50	B □	103	40	98	TRIAC	49,95€
60100B	10w	850Lm	3000K	100	>90	-20+50	B □	103	40	98	1-10V	59,95€
60100C	10w	850Lm	3000K	100	>90	-20+50	B □	103	40	98	DALI/PUSH	64,95€
60101	10w	900Lm	4000K	100	>90	-20+50	B □	103	40	98	ON/OFF	32,95€
60101A	10w	900Lm	4000K	100	>90	-20+50	B □	103	40	98	TRIAC	49,95€
60101B	10w	900Lm	4000K	100	>90	-20+50	B □	103	40	98	1-10V	59,95€
60101C	10w	900Lm	4000K	100	>90	-20+50	B □	103	40	98	DALI/PUSH	64,95€
60103	16w	1360Lm	3000K	100	>90	-20+50	B □	153	40	148	ON/OFF	59,95€
60103A	16w	1360Lm	3000K	100	>90	-20+50	B □	153	40	148	TRIAC	69,95€
60103B	16w	1360Lm	3000K	100	>90	-20+50	B □	153	40	148	1-10V	79,95€
60103C	16w	1360Lm	3000K	100	>90	-20+50	B □	153	40	148	DALI/PUSH	84,95€
60104	16w	1440Lm	4000K	100	>90	-20+50	B □	153	40	148	ON/OFF	59,95€
60104A	16w	1440Lm	4000K	100	>90	-20+50	B □	153	40	148	TRIAC	69,95€
60104B	16w	1440Lm	4000K	100	>90	-20+50	B □	153	40	148	1-10V	79,95€
60104C	16w	1440Lm	4000K	100	>90	-20+50	B □	153	40	148	DALI/PUSH	84,95€
60106	24w	1990Lm	3000K	100	>90	-20+50	B □	211	40	206	ON/OFF	69,95€
60106A	24w	1990Lm	3000K	100	>90	-20+50	B □	211	40	206	TRIAC	89,95€
60106B	24w	1990Lm	3000K	100	>90	-20+50	B □	211	40	206	1-10V	99,95€
60106C	24w	1990Lm	3000K	100	>90	-20+50	B □	211	40	206	DALI/PUSH	104,95€
60107	24w	2160Lm	4000K	100	>90	-20+50	B □	211	40	206	ON/OFF	69,95€
60107A	24w	2160Lm	4000K	100	>90	-20+50	B □	211	40	206	TRIAC	89,95€
60107B	24w	2160Lm	4000K	100	>90	-20+50	B □	211	40	206	1-10V	99,95€
60107C	24w	2160Lm	4000K	100	>90	-20+50	B □	211	40	206	DALI/PUSH	104,95€

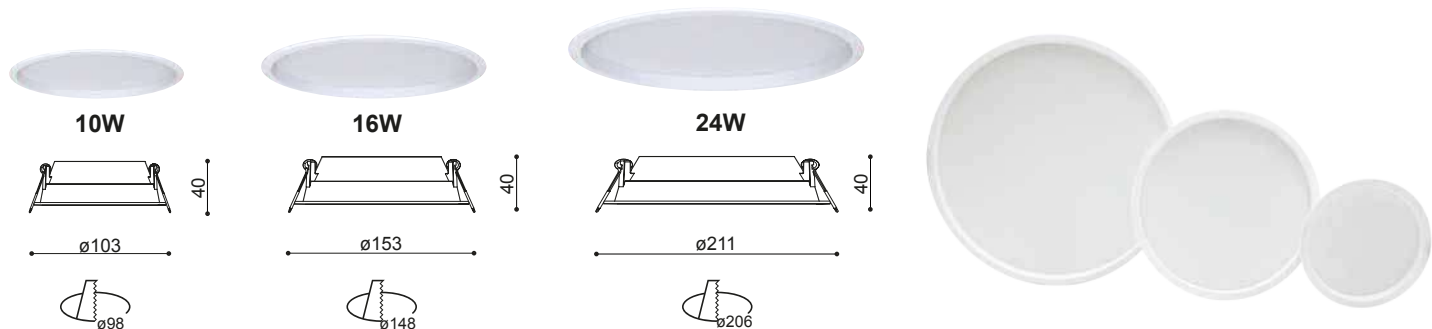



LYOPRO
LEVEL





2700 - 3000 - 4000K



Available in November 23

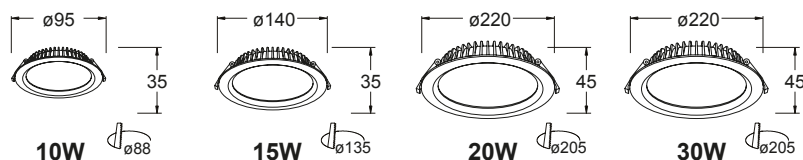

CÓDIGO	W	LM	K				ÓPTICA°	ELECTRÓNICA	PVP
63020	10w	1100Lm	3 CCT	88	95 35	<input type="checkbox"/> B <input type="checkbox"/> N <input type="checkbox"/> P	120	<u>SR</u> ON/OFF <u>A</u> TRIAC <u>B</u> 1-10V <u>C</u> DALI/PUSH	22,95€ 39,95€ 42,95€ 59,95€
63024	15w	1650Lm	3 CCT	135	140 35	<input type="checkbox"/> B <input type="checkbox"/> N <input type="checkbox"/> P	120	<u>SR</u> ON/OFF <u>A</u> TRIAC <u>B</u> 1-10V <u>C</u> DALI/PUSH	29,95€ 45,95€ 48,95€ 65,95€
63028	20w	2200Lm	3 CCT	205	220 45	<input type="checkbox"/> B <input type="checkbox"/> N <input type="checkbox"/> P	120	<u>SR</u> ON/OFF <u>A</u> TRIAC <u>B</u> 1-10V <u>C</u> DALI/PUSH	49,95€ 66,95€ 69,95€ 86,95€
63032	30w	3300Lm	3 CCT	205	220 45	<input type="checkbox"/> B <input type="checkbox"/> N <input type="checkbox"/> P	120	<u>SR</u> ON/OFF <u>A</u> TRIAC <u>B</u> 1-10V <u>C</u> DALI/PUSH	59,95€ 76,95€ 79,95€ 96,95€



2700 - 3000 - 4000K



Available in November 23

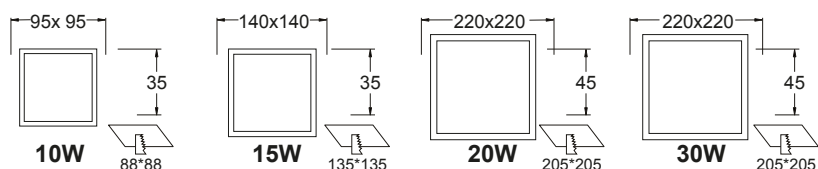

CÓDIGO	W	LM	K				ÓPTICA°	ELECTRÓNICA	PVP
				L	H				
63040	10w	1100Lm	3 CCT	88x88	95 35		120	<u>SR</u> ON/OFF <u>A</u> TRIAC <u>B</u> 1-10V <u>C</u> DALI/ PUSH	24,95€ 41,95€ 44,95€ 61,95€
63044	15w	1650Lm	3 CCT	135x 135	140 35		120	<u>SR</u> ON/OFF <u>A</u> TRIAC <u>B</u> 1-10V <u>C</u> DALI/ PUSH	31,95€ 47,95€ 50,95€ 67,95€
63048	20w	2200Lm	3 CCT	205x205	220 45		120	<u>SR</u> ON/OFF <u>A</u> TRIAC <u>B</u> 1-10V <u>C</u> DALI/ PUSH	51,95€ 68,95€ 71,95€ 88,95€
63052	30w	3300Lm	3 CCT	205x205	220 45		120	<u>SR</u> ON/OFF <u>A</u> TRIAC <u>B</u> 1-10V <u>C</u> DALI/ PUSH	61,95€ 78,95€ 81,95€ 98,95€

Interruptor 3 CCT Switch
que te permite cambiar la temperatura de color

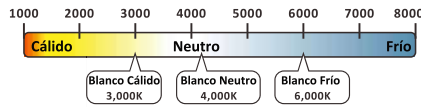

CÓDIGO	W	LM	K			ÓPTICA°	ELECTRÓNICA		PVP
60240	7w	770Lm	3 CCT 3000-4000-6000k	70	<input type="checkbox"/> B <input checked="" type="checkbox"/> N <input type="checkbox"/> P	110	<u>SR</u> <u>A</u> <u>B</u> <u>C</u>	ON/OFF TRIAC 1-10V DALI/ PUSH	24,70€ 41,70€ 44,70€ 61,70€

CÓDIGO	W	LM	K			ÓPTICA°	ELECTRÓNICA		PVP
60244	13w	1430Lm	3 CCT 3000-4000-6000k	115	<input type="checkbox"/> B <input checked="" type="checkbox"/> N <input type="checkbox"/> P	110	<u>SR</u> <u>A</u> <u>B</u> <u>C</u>	ON/OFF TRIAC 1-10V DALI/ PUSH	35,35€ 52,35€ 55,35€ 72,35€

CÓDIGO	W	LM	K			ÓPTICA°	ELECTRÓNICA		PVP
60248	15w	1650Lm	3 CCT 3000-4000-6000k	145	<input type="checkbox"/> B <input checked="" type="checkbox"/> N <input type="checkbox"/> P	110	<u>SR</u> <u>A</u> <u>B</u> <u>C</u>	ON/OFF TRIAC 1-10V DALI/ PUSH	42,95€ 59,95€ 62,95€ 79,95€

CÓDIGO	W	LM	K			ÓPTICA°	ELECTRÓNICA		PVP
60252	20w	2200Lm	3 CCT 3000-4000-6000k	165	<input type="checkbox"/> B <input checked="" type="checkbox"/> N <input type="checkbox"/> P	110	<u>SR</u> <u>A</u> <u>B</u> <u>C</u>	ON/OFF TRIAC 1-10V DALI/ PUSH	48,35€ 65,35€ 68,35€ 85,35€

CÓDIGO	W	LM	K			ÓPTICA°	ELECTRÓNICA		PVP
60260	20w	2200Lm	3 CCT 3000-4000-6000k	210	<input type="checkbox"/> B <input checked="" type="checkbox"/> N <input type="checkbox"/> P	110	<u>SR</u> <u>A</u> <u>B</u> <u>C</u>	ON/OFF TRIAC 1-10V DALI/ PUSH	53,70€ 70,70€ 73,70€ 90,70€

CÓDIGO	W	LM	K			ÓPTICA°	ELECTRÓNICA		PVP
60256	30w	3300Lm	3 CCT 3000-4000-6000k	210	<input type="checkbox"/> B <input checked="" type="checkbox"/> N <input type="checkbox"/> P	110	<u>SR</u> <u>A</u> <u>B</u> <u>C</u>	ON/OFF TRIAC 1-10V DALI/ PUSH	61,25€ 78,25€ 81,25€ 98,25€

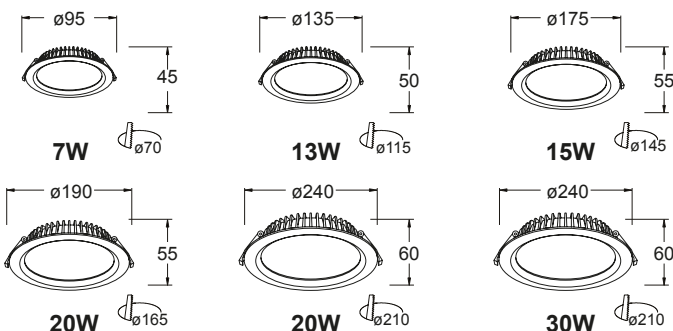

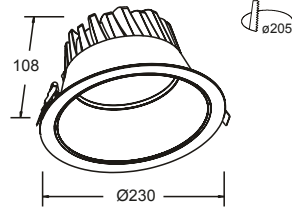

CÓDIGO	W	LM	K	VERSIÓN	ÓPTICA°	Ra/CRI	°C	Color	L	H	Ø	ELECTRÓNICA	PVP
10837	60w	5400Lm	4000K	Redondo	60	>80	-20+50	B	230	108	205	ON/OFF	96,25€
10837A	60w	5400Lm	4000K	Redondo	60	>80	-20+50	B	230	108	205	TRIAC	166,65€
10837B	60w	5400Lm	4000K	Redondo	60	>80	-20+50	B	230	108	205	1-10V	171,99€
10837C	60w	5400Lm	4000K	Redondo	60	>80	-20+50	B	230	108	205	DALI/ PUSH	171,99€



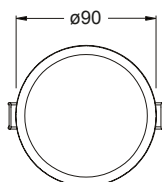
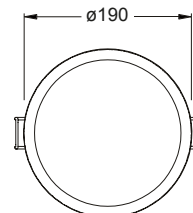
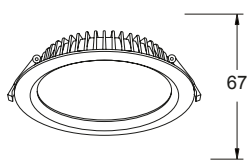
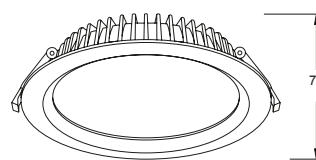

CÓDIGO	W	LM	K	ÓPTICA°	Ra/CRI		ELECTRÓNICA	PVP
60111	7w	560Lm	4000K	120	>80	B <input type="checkbox"/>	ON/OFF	39,70€
60111A	7w	560Lm	4000K	120	>80	B <input type="checkbox"/>	TRIAC	80,60€
60111B	7w	560Lm	4000K	120	>80	B <input type="checkbox"/>	1-10V	83,85€
60111C	7w	560Lm	4000K	120	>80	B <input type="checkbox"/>	DALI/PUSH	83,85€
60121	7w	560Lm	4000K	120	>80	N <input checked="" type="checkbox"/>	ON/OFF	42,90€
60121A	7w	560Lm	4000K	120	>80	N <input checked="" type="checkbox"/>	TRIAC	83,85€
60121B	7w	560Lm	4000K	120	>80	N <input checked="" type="checkbox"/>	1-10V	85,95€
60121C	7w	560Lm	4000K	120	>80	N <input checked="" type="checkbox"/>	DALI/PUSH	85,95€
60114	24w	1920Lm	4000K	120	>80	B <input type="checkbox"/>	ON/OFF	72,90€
60114A	24w	1920Lm	4000K	120	>80	B <input type="checkbox"/>	TRIAC	112,85€
60114B	24w	1920Lm	4000K	120	>80	B <input type="checkbox"/>	1-10V	116,10€
60114C	24w	1920Lm	4000K	120	>80	B <input type="checkbox"/>	DALI/PUSH	116,10€
60124	24w	1920Lm	4000K	120	>80	N <input checked="" type="checkbox"/>	ON/OFF	85,50€
60124A	24w	1920Lm	4000K	120	>80	N <input checked="" type="checkbox"/>	TRIAC	116,10€
60124B	24w	1920Lm	4000K	120	>80	N <input checked="" type="checkbox"/>	1-10V	118,25€
60124C	24w	1920Lm	4000K	120	>80	N <input checked="" type="checkbox"/>	DALI/PUSH	118,25€

7W

24W

HALO

CREE
LED CHIP

LiFud
LED Driver

IP
20

UGR < 19



220-245V
50/60Hz

Alu

Glass
Cover

EM



CE

3

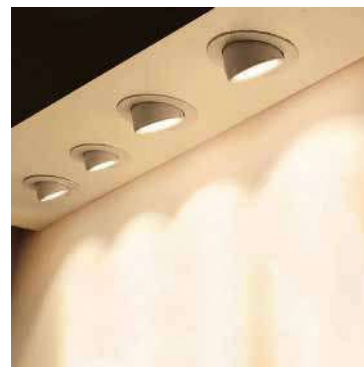
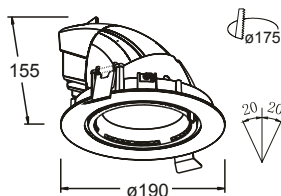

CÓDIGO	W	LM	K	ÓPTICA°	Ra/CRI				L	H		ELECTRÓNICA	PVP
60040	40w	3800Lm	3000K	38	>80	-20+45	B	<input type="checkbox"/>	190	155	175	ON/OFF	159,95€
60040A	40w	3800Lm	3000K	38	>80	-20+45	B	<input type="checkbox"/>	190	155	175	TRIAC	182,75€
60040B	40w	3800Lm	3000K	38	>80	-20+45	B	<input type="checkbox"/>	190	155	175	1-10V	185,95€
60040C	40w	3800Lm	3000K	38	>80	-20+45	B	<input type="checkbox"/>	190	155	175	DALI/PUSH	185,95€
60041	40w	4000Lm	4000K	38	>80	-20+45	B	<input type="checkbox"/>	190	155	175	ON/OFF	159,95€
60041A	40w	4000Lm	4000K	38	>80	-20+45	B	<input type="checkbox"/>	190	155	175	TRIAC	182,75€
60041B	40w	4000Lm	4000K	38	>80	-20+45	B	<input type="checkbox"/>	190	155	175	1-10V	185,95€
60041C	40w	4000Lm	4000K	38	>80	-20+45	B	<input type="checkbox"/>	190	155	175	DALI/PUSH	185,95€

EDNA

IP 20 | Acero | | | | CE | 3

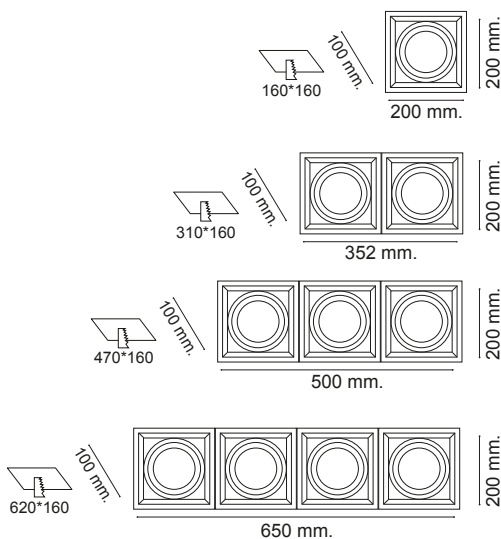

* Lamp not included
* Recommended lamp QR111 SIGMA

SIGMA



CÓDIGO	TIPO DE LÁMPARA	MATERIAL	L	W	H		PVP
60034	1xQR111	Acero	200	200	100	160*160	32,95€
60035	2xQR111	Acero	352	200	100	310*160	49,95€
60036	3xQR111	Acero	500	200	100	470*160	59,95€
60037	4xQR111	Acero	650	200	100	620*160	89,95€

CÓDIGO	W	LM	K	MATERIAL	VOLTAJE	TIPO DE LÁMPARA	L	H	ELECTRÓNICA	PVP
10203	15w	1280Lm	3000K	Aluminio	230V	QR111 - GU10	111	58	ON/OFF	25,95€
10204	15w	1300Lm	4000K	Aluminio	230V	QR111 - GU10	111	58	ON/OFF	25,95€
10206	15w	1280Lm	3000K	Aluminio	230V	QR111 - GU10	111	58	Reg. Phase Cut	34,95€
10207	15w	1300Lm	4000K	Aluminio	230V	QR111 - GU10	111	58	Reg. Phase Cut	34,95€

KASABI



LYOPRO

LEVEL



DOWNLIGHTS DE ALIMENTACIÓN
DOWNLIGHTS FOR FOOD
DOWNLIGHTS POUR L'ALIMENTATION

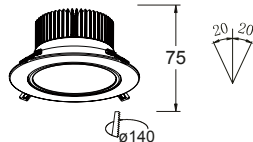
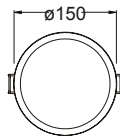

CÓDIGO	W	LM	K	ÓPTICA°	Ra/CRI	🌡️	🧠	L	H	🔌	ELECTRÓNICA	PVP
60030	30w	3450Lm	Carne	60	>90	-30+50	B <input type="checkbox"/>	150	75	125-140	ON/OFF	169,95€
60030A	30w	3450Lm	Carne	60	>90	-30+50	B <input type="checkbox"/>	150	75	125-140	TRIAC	189,95€
60030B	30w	3450Lm	Carne	60	>90	-30+50	B <input type="checkbox"/>	150	75	125-140	1-10V	199,95€
60030C	30w	3450Lm	Carne	60	>90	-30+50	B <input type="checkbox"/>	150	75	125-140	DALI/PUSH	199,95€
60031	30w	3450Lm	Pan	60	>90	-30+50	B <input type="checkbox"/>	150	75	125-140	ON/OFF	169,95€
60031A	30w	3450Lm	Pan	60	>90	-30+50	B <input type="checkbox"/>	150	75	125-140	TRIAC	189,95€
60031B	30w	3450Lm	Pan	60	>90	-30+50	B <input type="checkbox"/>	150	75	125-140	1-10V	199,95€
60031C	30w	3450Lm	Pan	60	>90	-30+50	B <input type="checkbox"/>	150	75	125-140	DALI/PUSH	199,95€
60032	30w	3450Lm	Fruta	60	>90	-30+50	B <input type="checkbox"/>	150	75	125-140	ON/OFF	169,95€
60032A	30w	3450Lm	Fruta	60	>90	-30+50	B <input type="checkbox"/>	150	75	125-140	TRIAC	189,95€
60032B	30w	3450Lm	Fruta	60	>90	-30+50	B <input type="checkbox"/>	150 <td 75	125-140	1-10V	199,95€	
60032C	30w	3450Lm	Fruta	60	>90	-30+50	B <input type="checkbox"/>	150	75	125-140	DALI/PUSH	199,95€



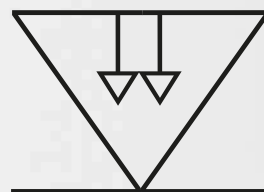

LYOPRO

LEVEL



MINI DOWNLIGHTS DE SUPERFICIE
SURFACE MINI DOWNLIGHTS
MINI DOWNLIGHTS DE SURFACE

LUA

bridgelux.
LED CHIP

IP
20

UGR < 19



160-265V
50/60Hz

Alu

Glass
Cover

EM



CE

3



3W

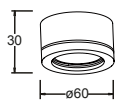

5W

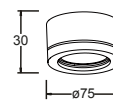

10W

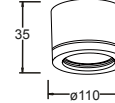

CÓDIGO	W	LM	K	ÓPTICA°	Ra/CRI	°C	Paleta	L	H	PVP
60050	3w	285Lm	3000K	60	>80	-20+50	B □	60	30	16,95€
60051	3w	300Lm	4000K	60	>80	-20+50	B □	60	30	16,95€
60053	5w	475Lm	3000K	60	>80	-20+50	B □	75	30	22,95€
60054	5w	500Lm	4000K	60	>80	-20+50	B □	75	30	22,95€
60056	10w	950Lm	3000K	60	>80	-20+50	B □	110	35	39,95€
60057	10w	1000Lm	4000K	60	>80	-20+50	B □	110	35	39,95€

ELIO

bridgelux.
LED CHIP

IP
20

UGR < 19



160-265V
50/60Hz

Alu

Glass
Cover

EM



CE

3



5W

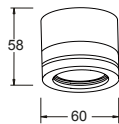

10W

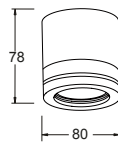

5W

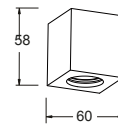

10W

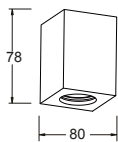

CÓDIGO	W	LM	K	ÓPTICA°	Ra/CRI	°C	VERSIÓN	Paleta	L	W	H	PVP
60071	5w	475Lm	3000K	60	>80	-20+50	Redondo	B □	60		58	22,95€
60072	5w	500Lm	4000K	60	>80	-20+50	Redondo	B □	60		58	22,95€
60080	5w	475Lm	3000K	60	>80	-20+50	Cuadrado	B □	60	60	58	25,95€
60081	5w	500Lm	4000K	60	>80	-20+50	Cuadrado	B □	60	60	58	25,95€
60074	10w	950Lm	3000K	60	>80	-20+50	Redondo	B □	80		78	37,95€
60075	10w	1000Lm	4000K	60	>80	-20+50	Redondo	B □	80		78	37,95€
60083	10w	950Lm	3000K	60	>80	-20+50	Cuadrado	B □	80	80	78	42,95€
60084	10w	1000Lm	4000K	60	>80	-20+50	Cuadrado	B □	80	80	78	42,95€

ALINA

bridgelux.
LED CHIP

IP
20

UGR < 19



160-265V
50/60Hz

Alu

Glass
Cover

EM



CE

3



5W



10W

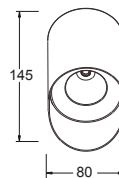
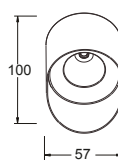

CÓDIGO	W	LM	K	VERSIÓN	ÓPTICA°	Ra/CRI	°C	Paleta	L	H	PVP
60089	5w	475Lm	3000K	Redondo	60	>80	-20+50	B □	57	100	24,95€
60090	5w	500Lm	4000K	Redondo	60	>80	-20+50	B □	57	100	24,95€
60092	10w	950Lm	3000K	Redondo	60	>80	-20+50	B □	80	145	43,95€
60093	10w	1000Lm	4000K	Redondo	60	>80	-20+50	B □	80	145	43,95€

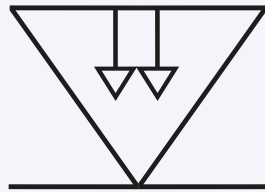

LYOPRO
LEVEL

DOWNLIGHTS DE SUPERFICIE
SURFACE DOWNLIGHTS
DOWNLIGHTS DE SURFACE

10W

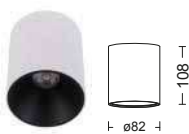

20W



30W

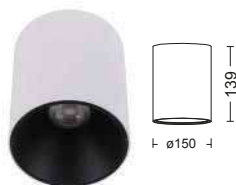

40W

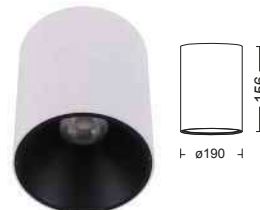

CÓDIGO	W	LM	K	EXTERIOR	ÓPTICA°	Ra/CRI	INTERIOR	ELECTRÓNICA	PVP
60500	10w	970Lm	3000K	B <input type="checkbox"/>	45	>90	B <input type="checkbox"/>	SR ON/OFF	76,95€
60501	10w	1000Lm	4000K	B <input type="checkbox"/>	45	>90	N <input checked="" type="checkbox"/>		
60503	10w	970Lm	3000K	N <input checked="" type="checkbox"/>	45	>90	PB <input type="checkbox"/>		
60504	10w	1000Lm	4000K	N <input checked="" type="checkbox"/>	45	>90	PM <input type="checkbox"/>		
							O <input type="checkbox"/>		

CÓDIGO	W	LM	K	EXTERIOR	ÓPTICA°	Ra/CRI	INTERIOR	ELECTRÓNICA	PVP
60506	20w	1960Lm	3000K	B <input type="checkbox"/>	45	>90	B <input type="checkbox"/>	SR ON/OFF	119,95€
60507	20w	2000Lm	4000K	B <input type="checkbox"/>	45	>90	N <input checked="" type="checkbox"/>	A TRIAC	156,90€
60509	20w	1960Lm	3000K	N <input checked="" type="checkbox"/>	45	>90	PB <input type="checkbox"/>	B 1-10V	166,60€
60510	20w	2000Lm	4000K	N <input checked="" type="checkbox"/>	45	>90	PM <input type="checkbox"/>	C DALI/PUSH	166,60€
							O <input type="checkbox"/>		

CÓDIGO	W	LM	K	EXTERIOR	ÓPTICA°	Ra/CRI	INTERIOR	ELECTRÓNICA	PVP
60512	30w	2920Lm	3000K	B <input type="checkbox"/>	45	>90	B <input type="checkbox"/>	SR ON/OFF	169,95€
60513	30w	3000Lm	4000K	B <input type="checkbox"/>	45	>90	N <input checked="" type="checkbox"/>	A TRIAC	193,50€
60515	30w	2920Lm	3000K	N <input checked="" type="checkbox"/>	45	>90	PB <input type="checkbox"/>	B 1-10V	199,95€
60516	30w	3000Lm	4000K	N <input checked="" type="checkbox"/>	45	>90	PM <input type="checkbox"/>	C DALI/PUSH	199,95€
							O <input type="checkbox"/>		

CÓDIGO	W	LM	K	EXTERIOR	ÓPTICA°	Ra/CRI	INTERIOR	ELECTRÓNICA	PVP
60518	40w	3900Lm	3000K	B <input type="checkbox"/>	45	>90	B <input type="checkbox"/>	SR ON/OFF	229,95€
60519	40w	4000Lm	4000K	B <input type="checkbox"/>	45	>90	N <input checked="" type="checkbox"/>	A TRIAC	242,95€
60521	40w	3900Lm	3000K	N <input checked="" type="checkbox"/>	45	>90	PB <input type="checkbox"/>	B 1-10V	247,25€
60522	40w	4000Lm	4000K	N <input checked="" type="checkbox"/>	45	>90	PM <input type="checkbox"/>	C DALI/PUSH	247,25€
							O <input type="checkbox"/>		

KIT SUSPENSIÓN ELSA

CÓDIGO	METROS	PVP
60546	1,5	21,45€
60547	3	23,60€
60548	5	25,75€



7W



12W



20W



CÓDIGO	W	LM	K	Ra/CRI	INSTALACIÓN	ÓPTICA°		ELECTRÓNICA	PVP	
						EXTERIOR	INTERIOR			
61400	7w	610Lm	3000K	>90	<u>S</u> Superficie	N <input checked="" type="checkbox"/>	<u>18</u>	B <input type="checkbox"/>	<u>SR</u> ON/OFF	78,95€
61401	7w	630Lm	4000K	>90		N <input checked="" type="checkbox"/>	<u>30</u>	N <input checked="" type="checkbox"/>	<u>A</u> TRIAC	98,95€
61403	7w	610Lm	3000K	>90		B <input type="checkbox"/>	<u>40</u>	PB <input type="checkbox"/>	<u>B</u> 1-10V	108,95€
61404	7w	630Lm	4000K	>90		B <input type="checkbox"/>		PM <input type="checkbox"/>	<u>C</u> DALI/PUSH	118,95€
								O <input type="checkbox"/>		

CÓDIGO	W	LM	K	Ra/CRI	INSTALACIÓN	ÓPTICA°		ELECTRÓNICA	PVP	
						EXTERIOR	INTERIOR			
61406	12w	1060Lm	3000K	>90	<u>S</u> Superficie	N <input checked="" type="checkbox"/>	<u>15</u>	B <input type="checkbox"/>	<u>SR</u> ON/OFF	99,95€
61407	12w	1080Lm	4000K	>90		N <input checked="" type="checkbox"/>	<u>20</u>	N <input checked="" type="checkbox"/>	<u>A</u> TRIAC	119,95€
61409	12w	1060Lm	3000K	>90		B <input type="checkbox"/>	<u>30</u>	PB <input type="checkbox"/>	<u>B</u> 1-10V	129,95€
61410	12w	1080Lm	4000K	>90		B <input type="checkbox"/>	<u>40</u>	PM <input type="checkbox"/>	<u>C</u> DALI/PUSH	139,95€
							<u>50</u>	O <input type="checkbox"/>		

CÓDIGO	W	LM	K	Ra/CRI	INSTALACIÓN	ÓPTICA°		ELECTRÓNICA	PVP	
						EXTERIOR	INTERIOR			
61412	20w	1780Lm	3000K	>90	<u>S</u> Superficie	N <input checked="" type="checkbox"/>	<u>15</u>	B <input type="checkbox"/>	<u>SR</u> ON/OFF	119,95€
61413	20w	1800Lm	4000K	>90		N <input checked="" type="checkbox"/>	<u>20</u>	N <input checked="" type="checkbox"/>	<u>A</u> TRIAC	139,95€
61415	20w	1780Lm	3000K	>90		B <input type="checkbox"/>	<u>45</u>	PB <input type="checkbox"/>	<u>B</u> 1-10V	149,95€
61416	20w	1800Lm	4000K	>90		B <input type="checkbox"/>	<u>55</u>	PM <input type="checkbox"/>	<u>C</u> DALI/PUSH	159,95€
								O <input type="checkbox"/>		





LYOPRO
LEVEL



LUMINARIAS DE SUSPENSIÓN
PENDANT LUMINAIRES
LUMINAIRES À SUSPENSION

7W

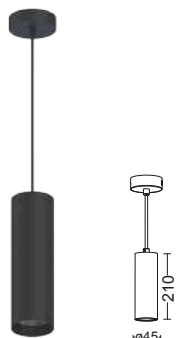

12W

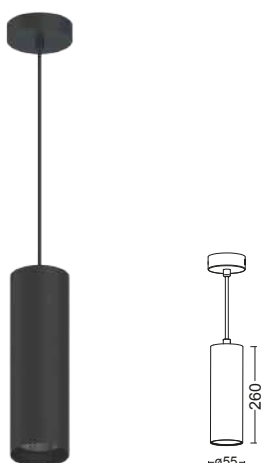

20W

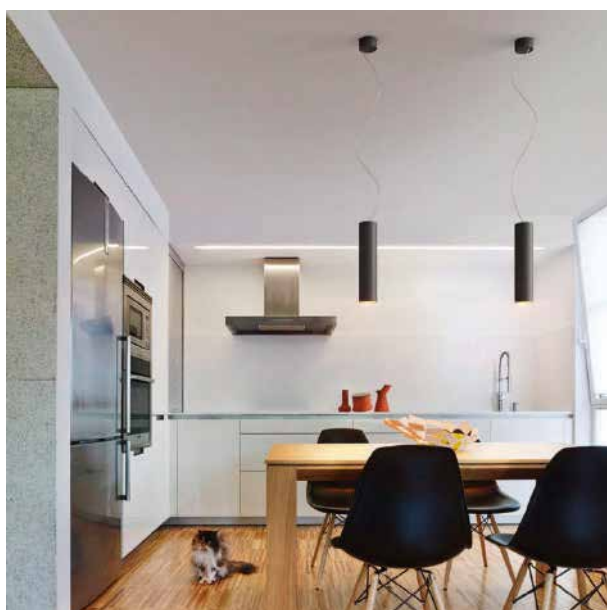
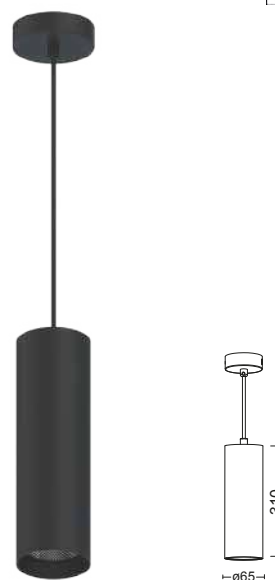

CÓDIGO	W	LM	K	Ra/CRI	INSTALACIÓN	ÓPTICA°		ELECTRÓNICA	PVP	
						EXTERIOR	INTERIOR			
61400	7w	610Lm	3000K	>90	<u>C</u> Colgante	N <input checked="" type="checkbox"/>	<u>18</u>	B <input type="checkbox"/>	<u>SR</u> ON/OFF	78,95€
61401	7w	630Lm	4000K	>90		N <input checked="" type="checkbox"/>	<u>30</u>	N <input checked="" type="checkbox"/>	<u>A</u> TRIAC	98,95€
61403	7w	610Lm	3000K	>90		B <input type="checkbox"/>	<u>40</u>	PB <input type="checkbox"/>	<u>B</u> 1-10V	108,95€
61404	7w	630Lm	4000K	>90		B <input type="checkbox"/>		PM <input type="checkbox"/>	<u>C</u> DALI/PUSH	118,95€
								O <input checked="" type="checkbox"/>		

CÓDIGO	W	LM	K	Ra/CRI	INSTALACIÓN	ÓPTICA°		ELECTRÓNICA	PVP	
						EXTERIOR	INTERIOR			
61406	12w	1060Lm	3000K	>90	<u>C</u> Colgante	N <input checked="" type="checkbox"/>	<u>15</u>	B <input type="checkbox"/>	<u>SR</u> ON/OFF	99,95€
61407	12w	1080Lm	4000K	>90		N <input checked="" type="checkbox"/>	<u>20</u>	N <input checked="" type="checkbox"/>	<u>A</u> TRIAC	119,95€
61409	12w	1060Lm	3000K	>90		B <input type="checkbox"/>	<u>30</u>	PB <input type="checkbox"/>	<u>B</u> 1-10V	129,95€
61410	12w	1080Lm	4000K	>90		B <input type="checkbox"/>	<u>40</u>	PM <input type="checkbox"/>	<u>C</u> DALI/PUSH	139,95€
							<u>50</u>	O <input checked="" type="checkbox"/>		

CÓDIGO	W	LM	K	Ra/CRI	INSTALACIÓN	ÓPTICA°		ELECTRÓNICA	PVP	
						EXTERIOR	INTERIOR			
61412	20w	1780Lm	3000K	>90	<u>C</u> Colgante	N <input checked="" type="checkbox"/>	<u>15</u>	B <input type="checkbox"/>	<u>SR</u> ON/OFF	119,95€
61413	20w	1800Lm	4000K	>90		N <input checked="" type="checkbox"/>	<u>20</u>	N <input checked="" type="checkbox"/>	<u>A</u> TRIAC	139,95€
61415	20w	1780Lm	3000K	>90		B <input type="checkbox"/>	<u>45</u>	PB <input type="checkbox"/>	<u>B</u> 1-10V	149,95€
61416	20w	1800Lm	4000K	>90		B <input type="checkbox"/>	<u>55</u>	PM <input type="checkbox"/>	<u>C</u> DALI/PUSH	159,95€
								O <input checked="" type="checkbox"/>		



LINEAR LIGHT

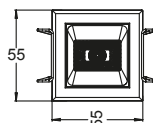
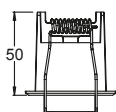

CÓDIGO	W	LM	K	Ra/CRI			ÓPTICA°	ELECTRÓNICA	PVP
60600	5w	475Lm	3000K	>90	-10+45	BN	<u>12</u>	<u>SR</u> ON/OFF	32,15€
60601	5w	500Lm	4000K	>90	-10+45	BN	<u>23</u>	<u>A</u> TRIAC	69,85€
60650	5w	475Lm	3000K	>90	-10+45	N	<u>38</u>	<u>B</u> 1-10V	75,25€
60651	5w	500Lm	4000K	>90	-10+45	N	<u>50</u>	<u>C</u> DALI/PUSH	75,25€
							3570 (35+70)		
							5050 (50+50)		

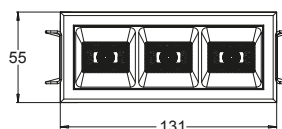
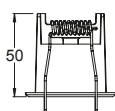
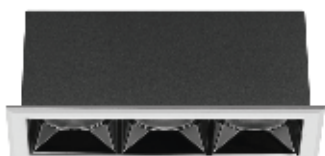

CÓDIGO	W	LM	K	Ra/CRI			ÓPTICA°	ELECTRÓNICA	PVP
60603	12w	1140Lm	3000K	>90	-10+45	BN	<u>12</u>	<u>SR</u> ON/OFF	64,40€
60604	12w	1200Lm	4000K	>90	-10+45	BN	<u>23</u>	<u>A</u> TRIAC	96,70€
60653	12w	1140Lm	3000K	>90	10+45	N	<u>38</u>	<u>B</u> 1-10V	102,10€
60654	12w	1200Lm	4000K	>90	-10+45	N	<u>50</u>	<u>C</u> DALI/PUSH	102,10€
							3570 (35+70)		
							5050 (50+50)		
							W (Wallwasher)		

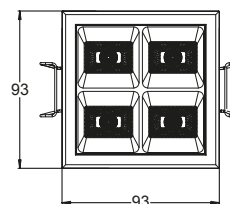
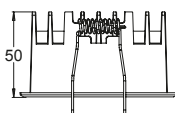

CÓDIGO	W	LM	K	Ra/CRI			ÓPTICA°	ELECTRÓNICA	PVP
60606	15w	1425Lm	3000K	>90	-10+45	BN	<u>12</u>	<u>SR</u> ON/OFF	96,65€
60607	15w	1500Lm	4000K	>90	-10+45	BN	<u>23</u>	<u>A</u> TRIAC	113,95€
60656	15w	1425Lm	3000K	>90	-10+45	N	<u>38</u>	<u>B</u> 1-10V	124,70€
60657	15w	1500Lm	4000K	>90	-10+45	N	<u>50</u>	<u>C</u> DALI/PUSH	124,70€
							3570 (35+70)		
							5050 (50+50)		

ORNA

CREE
LED CHIP

LiFUD
LED Driver

IP
20

UGR < 19



200-240V
50/60Hz

Alu

PC Difusser

EM



CE

3

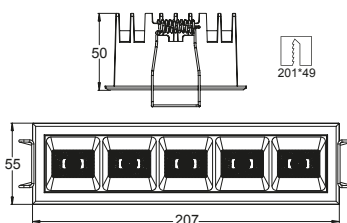
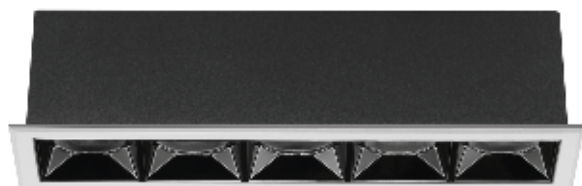

CÓDIGO	W	LM	K	Ra/CRI			ÓPTICA°	ELECTRÓNICA	PVP
60609	20w	1900Lm	3000K	>90	-10+45	BN	<u>12</u>	<u>SR</u> ON/OFF	107,40€
60610	20w	2000Lm	4000K	>90	-10+45	BN	<u>23</u>	<u>A</u> TRIAC	128,95€
60659	20w	1900Lm	3000K	>90	-10+45	N	<u>38</u>	<u>B</u> 1-10V	139,75€
60660	20w	2000Lm	4000K	>90	-10+45	N	<u>50</u>	<u>C</u> DALI/PUSH	139,75€
							<u>3570</u> (35+70)		
							<u>5050</u> (50+50)		
							<u>W</u> (Wallwasher)		

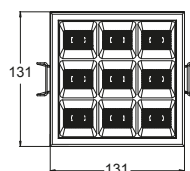
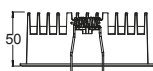

CÓDIGO	W	LM	K	Ra/CRI			ÓPTICA°	ELECTRÓNICA	PVP
60640	36w	3420Lm	3000K	>90	-10+45	BN	<u>12</u>	<u>SR</u> ON/OFF	150,45€
60641	36w	3600Lm	4000K	>90	-10+45	BN	<u>23</u>	<u>A</u> TRIAC	171,95€
60670	36w	3420Lm	3000K	>90	-10+45	N	<u>38</u>	<u>B</u> 1-10V	182,70€
60671	36w	3600Lm	4000K	>90	-10+45	N	<u>50</u>	<u>C</u> DALI/PUSH	182,70€
							<u>3570</u> (35+70)		
							<u>5050</u> (50+50)		

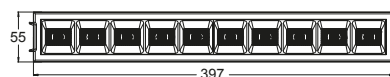
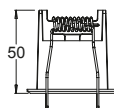

CÓDIGO	W	LM	K	Ra/CRI			ÓPTICA°	ELECTRÓNICA	PVP
60643	40w	3800Lm	3000K	>90	-10+45	BN	<u>12</u>	<u>SR</u> ON/OFF	166,60€
60644	40w	4000Lm	4000K	>90	-10+45	BN	<u>23</u>	<u>A</u> TRIAC	188,10€
60673	40w	3800Lm	3000K	>90	-10+45	N	<u>38</u>	<u>B</u> 1-10V	209,60€
60674	40w	4000Lm	4000K	>90	-10+45	N	<u>50</u>	<u>C</u> DALI/PUSH	209,60€
							<u>3570</u> (35+70)		
							<u>5050</u> (50+50)		
							<u>W</u> (Wallwasher)		

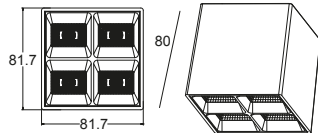

CÓDIGO	W	LM	K	Ra/CRI			ÓPTICA°	ELECTRÓNICA	PVP
60680	15w	1425Lm	3000K	>90	-10+45	BN	12	SR ON/OFF	96,65€
60681	15w	1500Lm	4000K	>90	-10+45	BN	23	A TRIAC	113,95€
60686	15w	1425Lm	3000K	>90	-10+45	N	38	B 1-10V	124,70€
60687	15w	1500Lm	4000K	>90	-10+45	N	50	C DALI/PUSH	124,70€
							3570 (35+70)		
							5050 (50+50)		

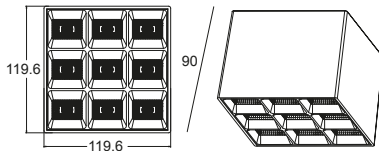

CÓDIGO	W	LM	K	Ra/CRI			ÓPTICA°	ELECTRÓNICA	PVP
60683	36w	3420Lm	3000K	>90	-10+45	BN	12	SR ON/OFF	150,45€
60684	36w	3600Lm	4000K	>90	-10+45	BN	23	A TRIAC	171,95€
60689	36w	3420Lm	3000K	>90	-10+45	N	38	B 1-10V	182,70€
60690	36w	3600Lm	4000K	>90	-10+45	N	50	C DALI/PUSH	182,70€
							3570 (35+70)		
							5050 (50+50)		



LYOPRO
LEVEL



ORNA TRIMLESS



TRIMLESS



Available in December 23

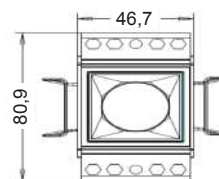
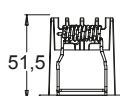

CÓDIGO	W	LM	K	Ra/CRI	INSTALACIÓN		ÓPTICA°	ELECTRÓNICA	PVP
64600	5w	475Lm	3000K	>90	Trimless	N	<u>12</u>	<u>SR</u> ON/OFF	52,15€
64601	5w	500Lm	4000K	>90	Trimless	N	<u>23</u> <u>38</u> <u>50</u>	<u>A</u> TRIAC <u>B</u> 1-10V <u>C</u> DALI/PUSH	89,85€ 95,25€ 95,25€
								<u>3570</u> (35+70) <u>5050</u> (50+50)	



TRIMLESS



Available in December 23

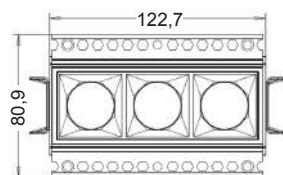
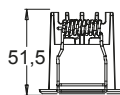

CÓDIGO	W	LM	K	Ra/CRI	INSTALACIÓN		ÓPTICA°	ELECTRÓNICA	PVP
64603	12w	1140Lm	3000K	>90	Trimless	N	<u>12</u>	<u>SR</u> ON/OFF	86,40€
64604	12w	1200Lm	4000K	>90	Trimless	N	<u>23</u> <u>38</u> <u>50</u>	<u>A</u> TRIAC <u>B</u> 1-10V <u>C</u> DALI/PUSH	118,70€ 124,10€ 124,10€
								<u>3570</u> (35+70) <u>5050</u> (50+50) <u>W</u> (Wallwasher)	



TRIMLESS



Available in December 23

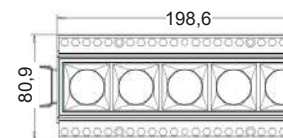
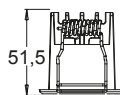

CÓDIGO	W	LM	K	Ra/CRI	INSTALACIÓN		ÓPTICA°	ELECTRÓNICA	PVP
64609	20w	1900Lm	3000K	>90	Trimless	N	<u>12</u>	<u>SR</u> ON/OFF	119,95€
64610	20w	2000Lm	4000K	>90	Trimless	N	<u>23</u> <u>38</u> <u>50</u>	<u>A</u> TRIAC <u>B</u> 1-10V <u>C</u> DALI/PUSH	136,95€ 147,95€ 147,95€
								<u>3570</u> (35+70) <u>5050</u> (50+50) <u>W</u> (Wallwasher)	

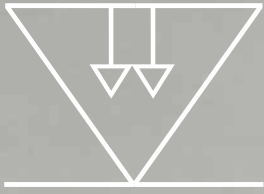

LYOPRO
LEVEL

LUMINARIAS DE ESCAYOLA
PLASTER LUMINAIRES
LUMINAIRES EN PLÂTRE

LEK

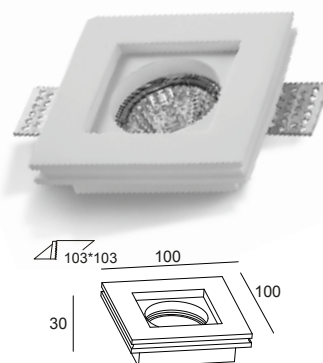
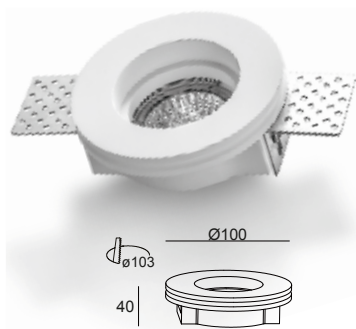

* Lamp not included

CÓDIGO	TIPO LÁMPARA	MATERIAL	VERSIÓN		L	W	H		PVP
60135	GU-10	Yeso	Redondo	B <input type="checkbox"/>	100		40	103	12,95€
60136	GU-10	Yeso	Cuadrado	B <input type="checkbox"/>	100	100	30	103*103	12,95€

KIAT

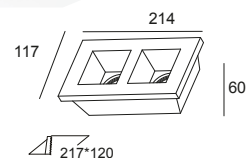
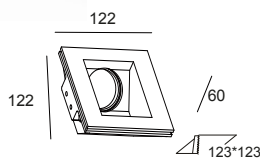
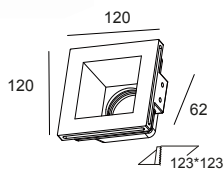

* Lamp not included

CÓDIGO	TIPO LÁMPARA	MATERIAL	VERSIÓN		L	W	H		PVP
60137	GU-10	Yeso	Cuadrado	B <input type="checkbox"/>	120	120	62	123*123	13,45€
60138	GU-10	Yeso	Cuadrado Asimétrico	B <input type="checkbox"/>	122	122	60	123*123	13,45€
60139	GU-10	Yeso	Rectangular	B <input type="checkbox"/>	214	117	60	217*120	25,25€

MANAT

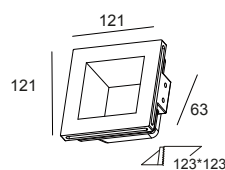
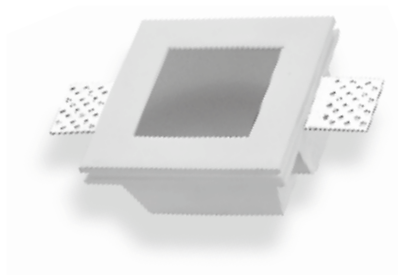

* Lamp not included

CÓDIGO	TIPO LÁMPARA	MATERIAL	VERSIÓN		L	W	H		PVP
60140	GU-10	Yeso	Cuadrado	B <input type="checkbox"/>	121	121	63	123*123	14,25€

LEVA

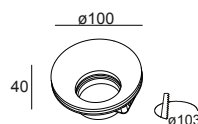

* Lamp not included

CÓDIGO	TIPO LÁMPARA	MATERIAL	VERSIÓN			L	H		PVP
60141	GU-10	Yeso	Redondo	B		100	40		11,00€

RIEL

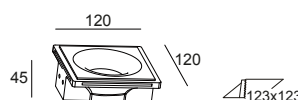
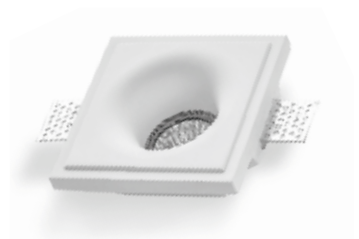

* Lamp not included

CÓDIGO	TIPO LÁMPARA	MATERIAL	VERSIÓN			L	W	H		PVP
60142	GU-10	Yeso	Cuadrado	B		120	120	45		16,10€

LITAS

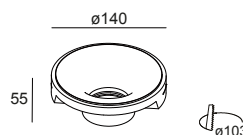

* Lamp not included

CÓDIGO	TIPO LÁMPARA	MATERIAL	VERSIÓN			L	H		PVP
60143	GU-10	Yeso	Redondo	B		140	55		15,00€

RUBLO

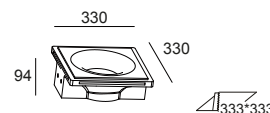
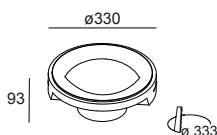
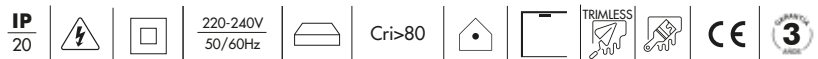

CÓDIGO	W	LM	K	ÓPTICA°	VERSIÓN				L	W	H		ELECTRÓNICA	PVP
60144	15w	1275Lm	3000K	100	Redondo	-20+45	B		330	93	333		ON/OFF	114,30€
60145	15w	1350Lm	4000K	100	Redondo	-20+45	B		330	93	333		ON/OFF	114,30€
60147	15w	1275Lm	3000K	100	Cuadrado	-20+45	B		330	330	93		ON/OFF	114,30€
60148	15w	1350Lm	4000K	100	Cuadrado	-20+45	B		330	330	94		ON/OFF	114,30€

WAT



IP
20



220-240V
50/60Hz

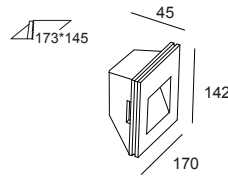

CÓDIGO	W	LM	K	ÓPTICA°	Ra/CRI			L	W	H		PVP
60149	1w	90Lm	2700K	100	>80	-20+45	B <input type="checkbox"/>	170	142	45	173*145	50,50€
60150	1w	95Lm	3000K	100	>80	-20+45	B <input type="checkbox"/>	170	142	45	173*145	50,50€
60151	1w	100Lm	4000K	100	>80	-20+45	B <input type="checkbox"/>	170	142	45	173*145	50,50€

YUAN



IP
20



220-240V
50/60Hz

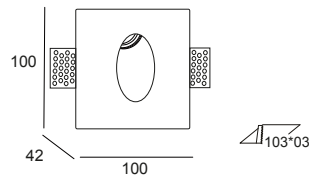

CÓDIGO	W	LM	K	ÓPTICA°	Ra/CRI			L	W	H		PVP
60152	1w	90Lm	2700K	100	>80	-20+45	B <input type="checkbox"/>	100	100	42	103*103	45,70€
60153	1w	95Lm	3000K	100	>80	-20+45	B <input type="checkbox"/>	100	100	42	103*103	45,70€
60154	1w	100Lm	4000K	100	>80	-20+45	B <input type="checkbox"/>	100	100	42	103*103	45,70€

TAKA



IP
20



220-240V
50/60Hz

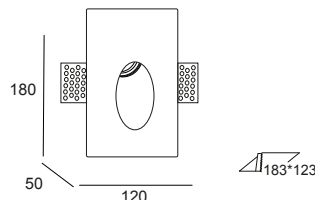

CÓDIGO	W	LM	K	ÓPTICA	Ra/CRI			L	W	H		PVP
60155	1w	90Lm	2700K	100	>80	-20+45	B <input type="checkbox"/>	180	120	50	183*123	49,95€
60156	1w	95Lm	3000K	100	>80	-20+45	B <input type="checkbox"/>	180	120	50	183*123	49,95€
60157	1w	100Lm	4000K	100	>80	-20+45	B <input type="checkbox"/>	180	120	50	183*123	49,95€

DIRHAM

IP 20 | 220-240V 50/60Hz | | | | TRIMLESS | | | CE |

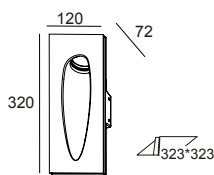

* Lamp not included

CÓDIGO	TIPO LÁMPARA	MATERIAL	VERSIÓN		L	W	H		PVP
60159	GU-10	Yeso	Rectangular	B	320	120	72		68,55€

JAYER

IP 20 | 220-240V 50/60Hz | | | | TRIMLESS | | | CE |

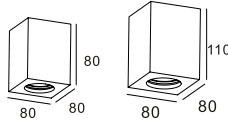
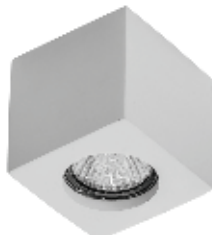
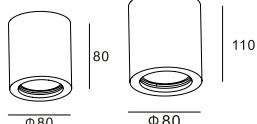

* Lámpara no incluida

CÓDIGO	TIPO LÁMPARA	MATERIAL	VERSIÓN		L	W	H	PVP
60170	GU-10	Yeso	Redondo	B	80	80		34,95€
60171	GU-10	Yeso	Redondo	B	80		110	36,95€
60172	GU-10	Yeso	Cuadrado	B	80	80	80	34,95€
60173	GU-10	Yeso	Cuadrado	B	80	80	110	36,95€

DONG

IP 20 | 220-240V 50/60Hz | | | | TRIMLESS | | | CE |

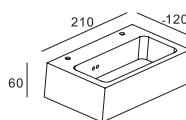

* Lamp not included

CÓDIGO	TIPO LÁMPARA	MATERIAL	VERSIÓN		L	W	H	PVP
60181	E-14	Yeso	Rectangular	B	210	60	120	53,45€

LILAN

IP 20 | 220-240V 50/60Hz | | | | TRIMLESS | | | CE |

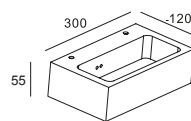

* Lamp not included

CÓDIGO	TIPO LÁMPARA	MATERIAL	VERSIÓN		L	W	H	PVP
60182	R7S	Yeso	Rectangular	B	300	55	120	79,95€

SUM



IP 20 |
 220-240V 50/60Hz |
 |
 |
 |
 |
 |
 |

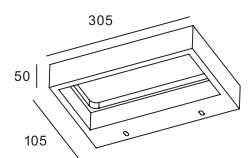

* Lamp not included

CÓDIGO	TIPO LÁMPARA	MATERIAL	VERSIÓN			L	W	H	PVP
60180	R7S	Yeso	Rectangular	B		305	50	105	68,55€

RAND



IP 20 |
 220-240V 50/60Hz |
 |
 |
 |
 |
 |
 |

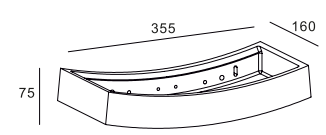

* Lamp not included

CÓDIGO	TIPO LÁMPARA	MATERIAL	VERSIÓN			L	W	H	PVP
60183	R7S	Yeso	Curvo	B		355	75	160	57,15€

NARIA



IP 20 |
 220-240V 50/60Hz |
 |
 |
 |
 |
 |
 |

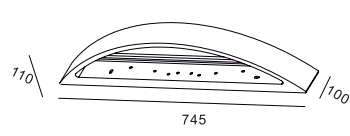

* Lamp not included

CÓDIGO	TIPO LÁMPARA	MATERIAL	VERSIÓN			L	W	H	PVP
60184	2xR7S	Yeso	Curvo	B		745	100	110	108,35€

LIBRA



IP 20 |
 220-240V 50/60Hz |
 |
 |
 |
 |
 |
 |

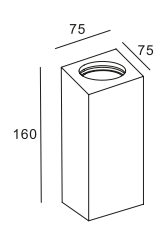

* Lamp not included

CÓDIGO	TIPO LÁMPARA	MATERIAL	VERSIÓN			L	W	H	PVP
60185	2xGU-10	Yeso	Rectangular	B		75	75	160	61,65€

RECOMENDACIONES DE INSTALACIÓN
INSTALLATION RECOMMENDATIONS
RECOMMANDATIONS D'INSTALLATION



IMAGEN 1



IMAGEN 2



IMAGEN 3

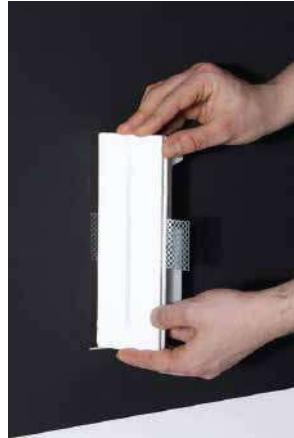

IMAGEN 4



IMAGEN 5



IMAGEN 6



IMAGEN 7



IMAGEN 8



LUMINARIAS DECORATIVAS DECORATIVE LUMINAIRES LUMINAIRES DÉCORATIFS

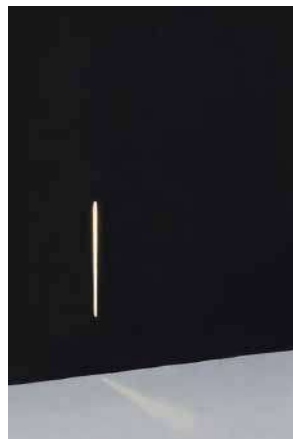

LYOPRO
LEVEL

DENAR

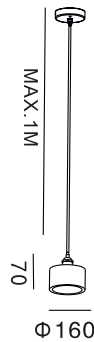

* Lamp not included

CÓDIGO	TIPO LÁMPARA	MATERIAL	PI	L		H	PVP
				L	H		
60190	E-27	Piedra	PI	160	70		107,50€

DENAR

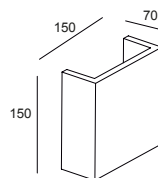

* Lamp not included

CÓDIGO	TIPO LÁMPARA	MATERIAL	PI	L			PVP
				L	W	H	
60191	G-9	Piedra	PI	150	150	70	91,35€



LYOPRO
LEVEL



LUMINARIAS DE CARRIL
TRACK LUMINAIRES
LUMINAIRES SUR RAIL



2700 - 3000 - 4000K



Available in October 23

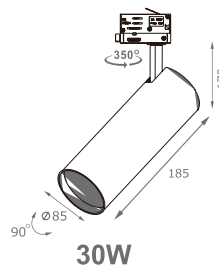
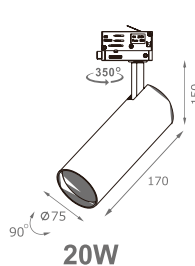
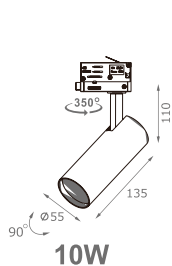

CÓDIGO	W	LM	K	ÓPTICA°		CRI		L	H	ELECTRÓNICA	PVP
61550	10w	1200lm	3 CCT	<u>15</u>	B <input type="checkbox"/>	<90	-30+50	55	135	ON/OFF	69,95€
61551	10w	1200lm	3 CCT	<u>24</u>	N <input checked="" type="checkbox"/>	<90	-30+50	55	135	ON/OFF	69,95€
61552	20w	2400lm	3 CCT	<u>38</u>	B <input type="checkbox"/>	<90	-30+50	75	170	ON/OFF	99,95€
61553	20w	2400lm	3 CCT	<u>45</u>	N <input checked="" type="checkbox"/>	<90	-30+50	75	170	ON/OFF	99,95€
61554	30w	3600lm	3 CCT	<u>60</u>	B <input type="checkbox"/>	<90	-30+50	85	185	ON/OFF	119,95€
61555	30w	3600lm	3 CCT		N <input checked="" type="checkbox"/>	<90	-30+50	85	185	ON/OFF	119,95€

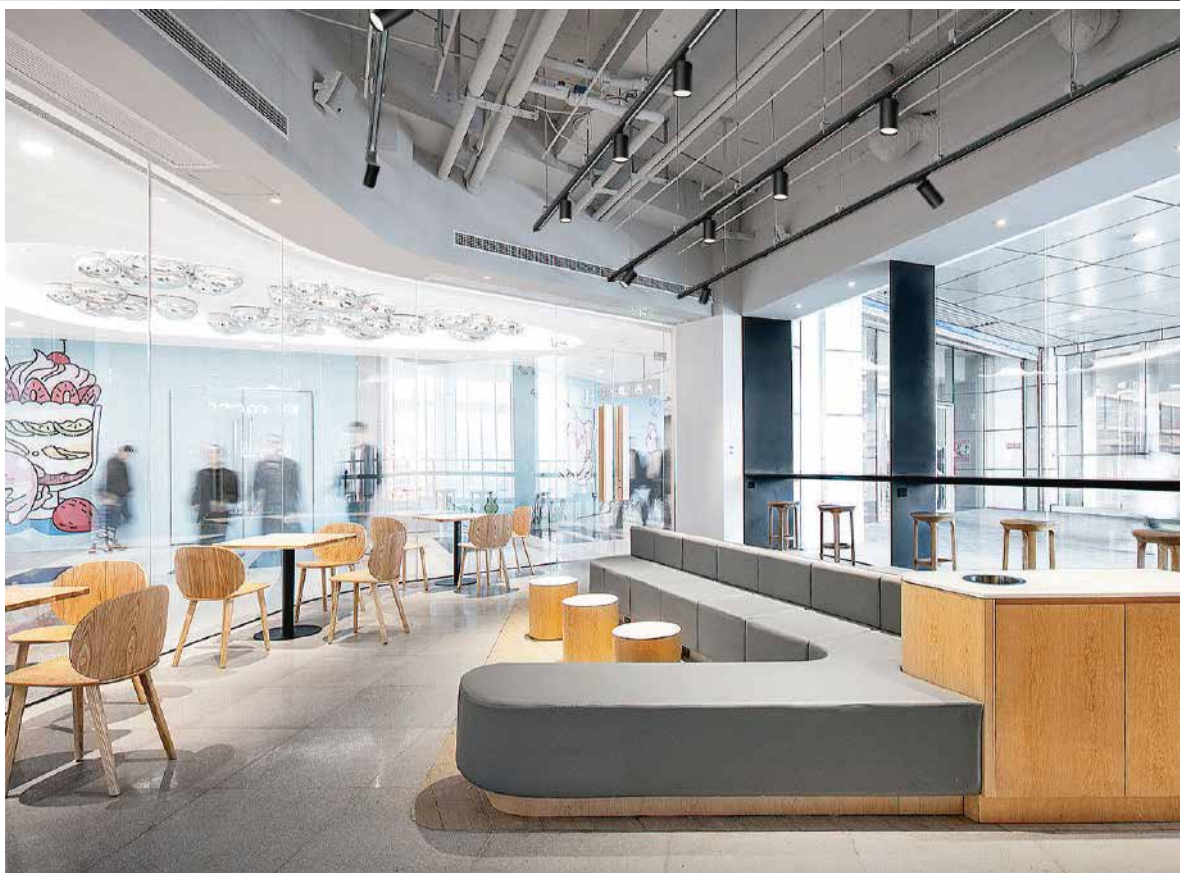

*Interruptor 3 CCT Switch
que te permite cambiar la temperatura de color*

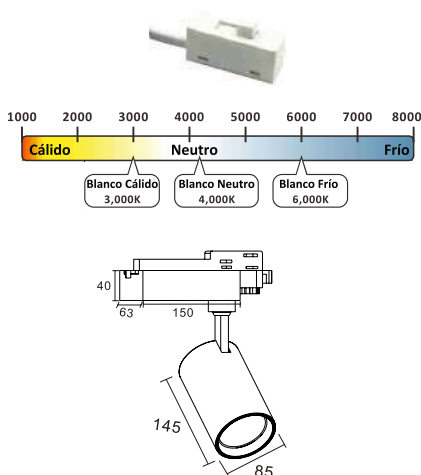

CÓDIGO	W	LM	K	ÓPTICA°		UGR		L	H	ELECTRÓNICA	PVP
61500	34w	3400Lm	3 CCT	<u>30</u>	<input type="checkbox"/> B	<19	-30+50	85	145	<u>SR</u> ON/OFF	195,95€
61507	34w	3400Lm	3 CCT	<u>38</u>	<input type="checkbox"/> N	<19	-30+50	85	145	<u>A</u> TRIAC	219,95€
				<u>60</u>						<u>B</u> 1-10V	224,95€
										<u>C</u> PUSH/DALI	239,95€

ACCESORIOS ORLI

MODULO CONFORT VISUAL
UGR13 NEGRO
CÓDIGO: 61526
PVP: 21,40€



PANEL DE ABEJA
UGR9 NEGRO
CÓDIGO: 61527
PVP: 26,75€



REFLECTOR ALU CON ARO 60°
CÓDIGO: 61528 NEGRO
PVP: 21,40€



ALETAS
ANTIDESLUMBRAMIENTO
CÓDIGO: 61530 NEGRA
PVP: 26,75€



CÓDIGO: 61529 BLANCA
PVP: 21,40€

CÓDIGO: 61531 BLANCA
PVP: 26,75€





2700 - 3000 - 4000K



Available in December 23

20W

30W

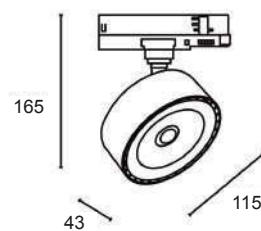
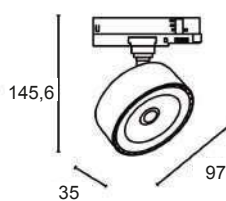

CÓDIGO	W	LM	K	ÓPTICA°		UGR		L	H	ELECTRÓNICA	PVP
61680	20w	2400Lm	3 CCT	<u>15</u>	B <input type="checkbox"/>	>19	-20+45	35	97	ON/OFF	69,95€
61681	20w	2400Lm	3 CCT	<u>24</u>	N <input checked="" type="checkbox"/>	>19	-20+45	35	97	ON/OFF	69,95€
61682	30w	3600Lm	3 CCT	<u>36</u>	B <input type="checkbox"/>	>19	-20+45	43	115	ON/OFF	89,95€
61683	30w	3600Lm	3 CCT	<u>60</u>	N <input checked="" type="checkbox"/>	>19	-20+45	43	115	ON/OFF	89,95€





2700 - 3000 - 4000K



Available in December 23

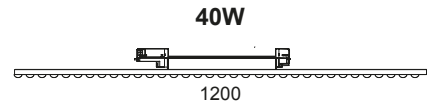
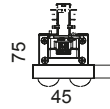
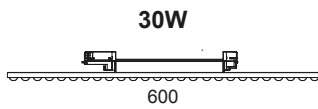
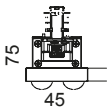

CÓDIGO	W	LM	K	ÓPTICA°	UGR					ELECTRÓNICA	PVP
							L	W	H		
63080	30w	3750Lm	3 CCT	60	>19	B <input type="checkbox"/>	600	45	75	ON/OFF	79,95€
63081	30w	3750Lm	3 CCT	60	>19	N <input type="checkbox"/>	600	45	75	ON/OFF	79,95€
63082	40w	4880Lm	3 CCT	60	>19	B <input type="checkbox"/>	1200	45	75	ON/OFF	109,95€
63083	40w	4880Lm	3 CCT	60	>19	N <input type="checkbox"/>	1200	45	75	ON/OFF	109,95€



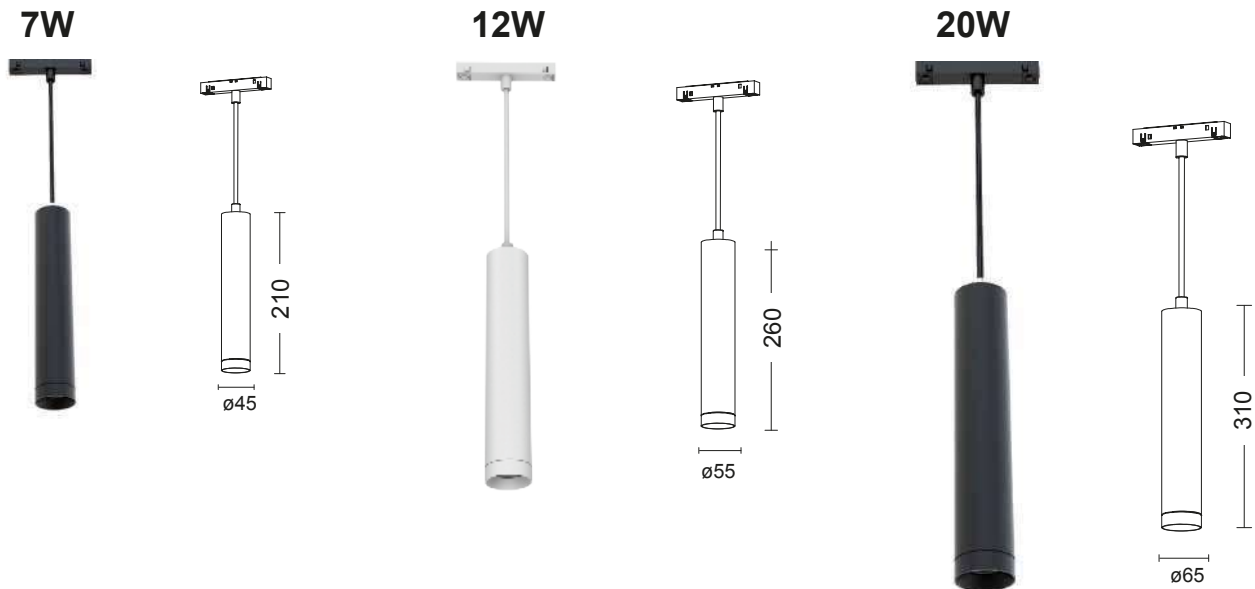

CÓDIGO	W	LM	K	INSTALACIÓN	EXTERIOR	ÓPTICA°	INTERIOR	ELECTRÓNICA	PVP
61400	7w	610Lm	3000K	CC Colgante Carril	N <input checked="" type="checkbox"/>	18	B <input type="checkbox"/>	SR ON/OFF	89,95€
61401	7w	630Lm	4000K		N <input checked="" type="checkbox"/>	30	N <input checked="" type="checkbox"/>	A TRIAC	119,95€
61403	7w	610Lm	3000K		B <input type="checkbox"/>	40	PB <input type="checkbox"/>	B 1-10V	129,95€
61404	7w	630Lm	4000K		B <input type="checkbox"/>		PM <input type="checkbox"/>	C PUSH/DALI	139,95€

CÓDIGO	W	LM	K	INSTALACIÓN	EXTERIOR	ÓPTICA°	INTERIOR	ELECTRÓNICA	PVP
61406	12w	1060Lm	3000K	CC Colgante Carril	N <input checked="" type="checkbox"/>	15	B <input type="checkbox"/>	SR ON/OFF	109,95€
61407	12w	1080Lm	4000K		N <input checked="" type="checkbox"/>	20	N <input checked="" type="checkbox"/>	A TRIAC	129,95€
61409	12w	1060Lm	3000K		B <input type="checkbox"/>	30	PB <input type="checkbox"/>	B 1-10V	139,95€
61410	12w	1080Lm	4000K		B <input type="checkbox"/>	40	PM <input type="checkbox"/>	C PUSH/DALI	149,95€

CÓDIGO	W	LM	K	INSTALACIÓN	EXTERIOR	ÓPTICA°	INTERIOR	ELECTRÓNICA	PVP
61412	20w	1780Lm	3000K	CC Colgante Carril	N <input checked="" type="checkbox"/>	15	B <input type="checkbox"/>	SR ON/OFF	129,95€
61413	20w	1800Lm	4000K		N <input checked="" type="checkbox"/>	20	N <input checked="" type="checkbox"/>	A TRIAC	149,95€
61415	20w	1780Lm	3000K		B <input type="checkbox"/>	45	PB <input type="checkbox"/>	B 1-10V	159,95€
61416	20w	1800Lm	4000K		B <input type="checkbox"/>	55	PM <input type="checkbox"/>	C PUSH/DALI	169,95€

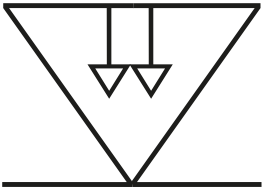

LYOPRO
LEVEL

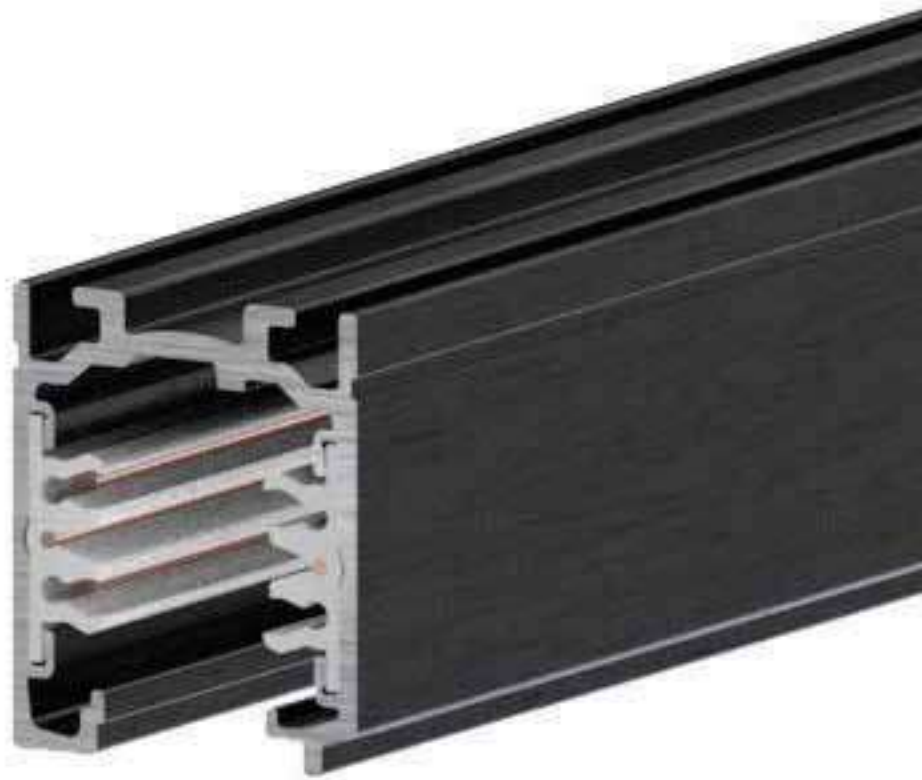

TRACK SYSTEM

TRACK SYSTEM TRIFÁSICO

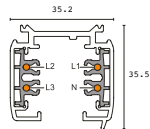

CARRIL TRIFÁSICO SUPERFICIE DE 1 METRO
NEGRO **CÓDIGO:** 62496
BLANCO **CÓDIGO:** 62497
PVP: 39,75€

CARRIL TRIFÁSICO SUPERFICIE DE 2 METROS
NEGRO **CÓDIGO:** 62504
BLANCO **CÓDIGO:** 62506
PVP: 76,50€

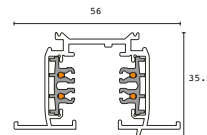

CARRIL TRIFÁSICO EMPOTRAR DE 1 METRO
NEGRO **CÓDIGO:** 62494
BLANCO **CÓDIGO:** 62495
PVP: 50,95€

CARRIL TRIFÁSICO EMPOTRAR DE 2 METROS
NEGRO **CÓDIGO:** 62500
BLANCO **CÓDIGO:** 62502
PVP: 101,50€

ACCESORIOS

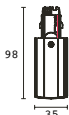

ALIMENTADOR TIERRA A IZQUIERDA
NEGRO **CÓDIGO:** 62510
BLANCO **CÓDIGO:** 62511
PVP: 17,50€



ALIMENTADOR TIERRA A DERECHA
NEGRO **CÓDIGO:** 62512
BLANCO **CÓDIGO:** 62513
PVP: 17,50€

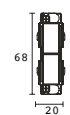

UNIÓN ELECTRICA
NEGRO **CÓDIGO:** 62514
BLANCO **CÓDIGO:** 62515
PVP: 9,95€

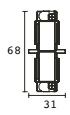

UNIÓN MECÁNICA
NEGRO **CÓDIGO:** 62516
BLANCO **CÓDIGO:** 62517
PVP: 6,50€



UNIÓN ELECTRICA CENTRAL
NEGRO **CÓDIGO:** 62518
BLANCO **CÓDIGO:** 62519
PVP: 33,35€

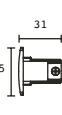

TAPA FINAL
NEGRO **CÓDIGO:** 62526
BLANCO **CÓDIGO:** 62527
PVP: 2,25€

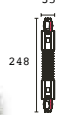

UNIÓN FLEXIBLE
NEGRO **CÓDIGO:** 62520
BLANCO **CÓDIGO:** 62521
PVP: 42,75€



CONECTOR AJUSTABLE
NEGRO **CÓDIGO:** 62522
BLANCO **CÓDIGO:** 62523
PVP: 34,95€

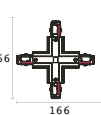

CONECTOR EN "X"
NEGRO **CÓDIGO:** 62524
BLANCO **CÓDIGO:** 62525
PVP: 57,25€

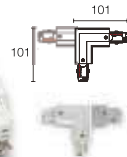

CONECTOR EN "L" REVERSIBLE (IZQ.-DER.)
NEGRO **CÓDIGO:** 62528
BLANCO **CÓDIGO:** 62529
PVP: 36,50€

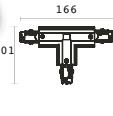

CONECTOR EN "T" REVERSIBLE (IZQ. 1-IZQ. 2)
NEGRO **CÓDIGO:** 62530
BLANCO **CÓDIGO:** 62531
PVP: 47,35€

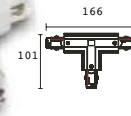
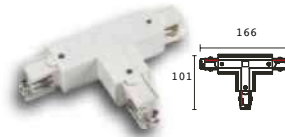

CONECTOR EN "T" REVERSIBLE (DER. 1-DER. 2)
NEGRO **CÓDIGO:** 62532
BLANCO **CÓDIGO:** 62533
PVP: 47,35€

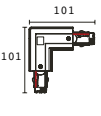
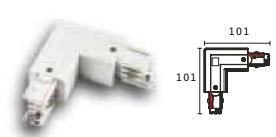

CONECTOR EN "L" IZQUIERDA
NEGRO **CÓDIGO:** 62534
BLANCO **CÓDIGO:** 62535
PVP: 32,95€

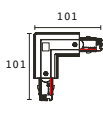

CONECTOR EN "L" DERECHA
NEGRO **CÓDIGO:** 62536
BLANCO **CÓDIGO:** 62537
PVP: 32,95€

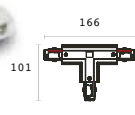

CONECTOR EN "T" IZQUIERDA
NEGRO **CÓDIGO:** 62538
BLANCO **CÓDIGO:** 62539
PVP: 49,50€

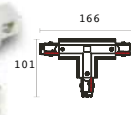
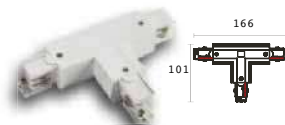

CONECTOR EN "T" IZQUIERDA 2
NEGRO **CÓDIGO:** 62540
BLANCO **CÓDIGO:** 62541
PVP: 49,50€

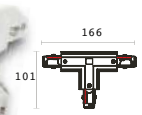

CONECTOR EN "T" DERECHA
NEGRO **CÓDIGO:** 62542
BLANCO **CÓDIGO:** 62543
PVP: 49,50€

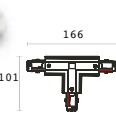

CONECTOR EN "T" DERECHA 2
NEGRO **CÓDIGO:** 62544
BLANCO **CÓDIGO:** 62545
PVP: 49,50€

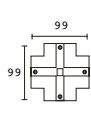

ENVELECEDOR CONECTOR "X"
NEGRO **CÓDIGO:** 62668
BLANCO **CÓDIGO:** 62669
PVP: 5,15€

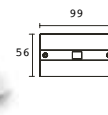

TAPA UNIÓN INTERMEDIA
NEGRO **CÓDIGO:** 62670
BLANCO **CÓDIGO:** 62671
PVP: 4,50€

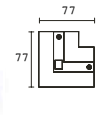

TAPA UNIÓN EN "L"
NEGRO **CÓDIGO:** 62672
BLANCO **CÓDIGO:** 62673
PVP: 4,30€

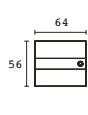

TAPA UNIÓN
NEGRO **CÓDIGO:** 62674
BLANCO **CÓDIGO:** 62675
PVP: 3,35€

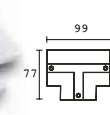

TAPA UNIÓN EN "T"
NEGRO **CÓDIGO:** 62676
BLANCO **CÓDIGO:** 62677
PVP: 4,50€

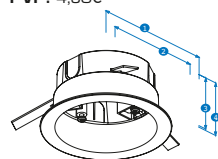

1. 130mm 2. 105mm 3. 58mm 4. 60mm
ADAPTADOR EMPOTRAR UNITARIO
NEGRO **CÓDIGO:** 62440
BLANCO **CÓDIGO:** 62441
PVP: 40,90€

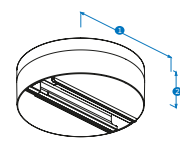

1. 100mm 2. 32mm
ADAPTADOR SUPERFICIE UNITARIO
NEGRO **CÓDIGO:** 62442
BLANCO **CÓDIGO:** 62443
PVP: 46,70€

TRACK SYSTEM TRIFÁSICO DALI

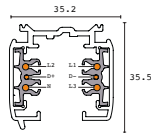

CARRIL TRIFÁSICO SUPERFICIE DE 1 METRO
NEGRO **CÓDIGO:** 62396
BLANCO **CÓDIGO:** 62397
PVP: 46,70€

CARRIL TRIFÁSICO SUPERFICIE DE 2 METROS
NEGRO **CÓDIGO:** 62404
BLANCO **CÓDIGO:** 62406
PVP: 93,15€

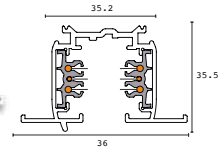

CARRIL TRIFÁSICO EMPOTRAR DE 1 METRO
NEGRO **CÓDIGO:** 62394
BLANCO **CÓDIGO:** 62395
PVP: 55,95€

CARRIL TRIFÁSICO EMPOTRAR DE 2 METROS
NEGRO **CÓDIGO:** 62400
BLANCO **CÓDIGO:** 62402
PVP: 110,95€

ACCESORIOS

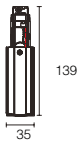

ALIMENTADOR TIERRA A IZQUIERDA
NEGRO **CÓDIGO:** 62410
BLANCO **CÓDIGO:** 62411
PVP: 18,95€

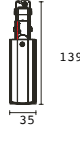

ALIMENTADOR TIERRA A DERECHA
NEGRO **CÓDIGO:** 62412
BLANCO **CÓDIGO:** 62413
PVP: 19,10€

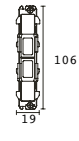

UNIÓN ELECTRICA
NEGRO **CÓDIGO:** 62414
BLANCO **CÓDIGO:** 62415
PVP: 13,50€

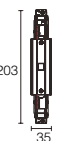

UNIÓN ELECTRICA CENTRAL
NEGRO **CÓDIGO:** 62418
BLANCO **CÓDIGO:** 62419
PVP: 38,95€



TAPA FINAL
NEGRO **CÓDIGO:** 62526
BLANCO **CÓDIGO:** 62527
PVP: 2,25€



UNIÓN FLEXIBLE
NEGRO **CÓDIGO:** 62420
BLANCO **CÓDIGO:** 62421
PVP: 55,95€

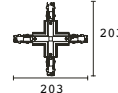

CONECTOR EN "X"
NEGRO **CÓDIGO:** 62530
BLANCO **CÓDIGO:** 62531
PVP: 86,85€

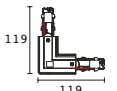

CONECTOR EN "L" TIERRA EXTERIOR
NEGRO **CÓDIGO:** 62424
BLANCO **CÓDIGO:** 62425
PVP: 47,75€



CONECTOR EN "L" TIERRA INTERIOR
NEGRO **CÓDIGO:** 62422
BLANCO **CÓDIGO:** 62423
PVP: 47,75€

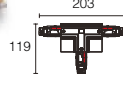

CONECTOR EN "T" IZQUIERDA 1
NEGRO **CÓDIGO:** 62428
BLANCO **CÓDIGO:** 62429
PVP: 73,75€

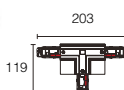

CONECTOR EN "T" IZQUIERDA 2
NEGRO **CÓDIGO:** 62478
BLANCO **CÓDIGO:** 62479
PVP: 73,75€

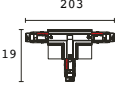

CONECTOR EN "T" DERECHA 1
NEGRO **CÓDIGO:** 62426
BLANCO **CÓDIGO:** 62427
PVP: 73,75€

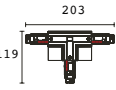

CONECTOR EN "T" DERECHA 2
NEGRO **CÓDIGO:** 62476
BLANCO **CÓDIGO:** 62477
PVP: 73,75€

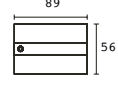

TAPA UNIÓN
NEGRO **CÓDIGO:** 62680
BLANCO **CÓDIGO:** 62681
PVP: 5,25€



TAPA UNIÓN EN "T"
NEGRO **CÓDIGO:** 62674
BLANCO **CÓDIGO:** 62675
PVP: 3,35€



TAPA UNIÓN EN "L"
NEGRO **CÓDIGO:** 62672
BLANCO **CÓDIGO:** 62673
PVP: 4,30€



TAPA UNIÓN EN "X"
NEGRO **CÓDIGO:** 62668
BLANCO **CÓDIGO:** 62669
PVP: 5,15€

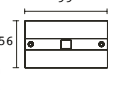

TAPA UNIÓN INTERMEDIA
NEGRO **CÓDIGO:** 62670
BLANCO **CÓDIGO:** 62671
PVP: 4,50€

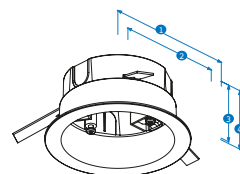

1. 130mm 2. 105mm 3. 58mm 4. 60mm

ADAPTADOR EMPOTRAR UNITARIO
NEGRO **CÓDIGO:** 62440
BLANCO **CÓDIGO:** 62441
PVP: 40,90€

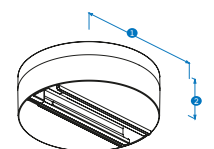

1. 100mm 2. 32mm

ADAPTADOR SUPERFICIE UNITARIO
NEGRO **CÓDIGO:** 62442
BLANCO **CÓDIGO:** 62443
PVP: 46,70€

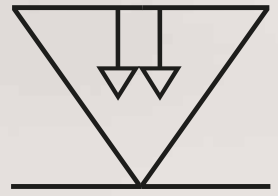

LYOPRO

LEVEL

ILUMINACIÓN DE INTERIOR EMPOTRADA
RECESSED INDOOR LIGHTING
ÉCLAIRAGE INTÉRIEUR ENCASTRÉ



Available in October 23

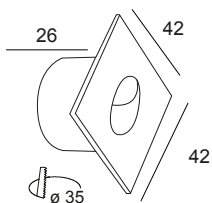
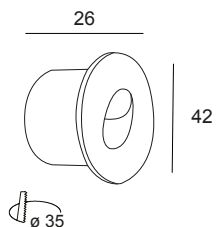
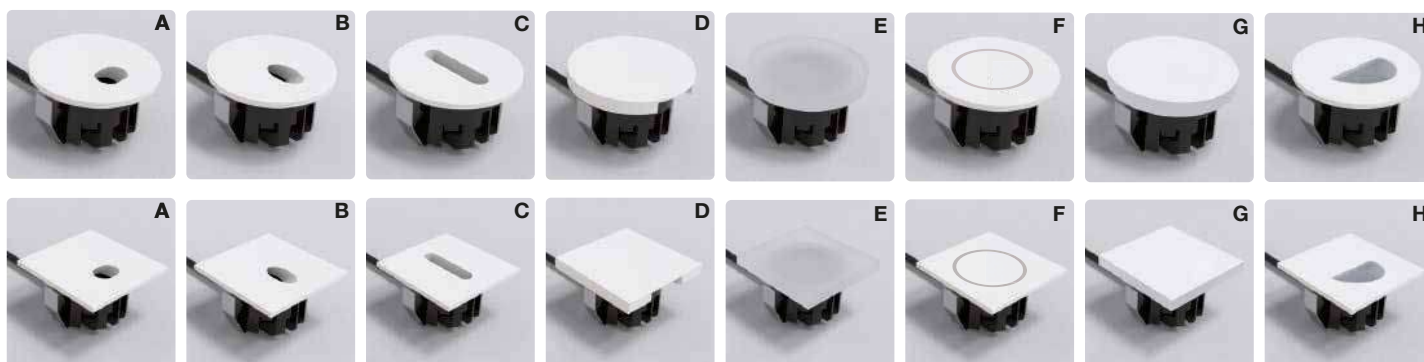

CÓDIGO	W	LM	K	TIPO	VERSIÓN		ELECTRÓNICA	PVP
62900	3w	240Lm	2700K	<u>A</u>	<u>R</u> Redondo	<u>B</u>	ON/OFF	19,95€
62901	3w	250Lm	3000K	<u>B</u>	<u>C</u> Cuadrado	<u>N</u>	ON/OFF	19,95€
62902	3w	260Lm	4000K	<u>C</u> <u>D</u> <u>F</u> <u>G</u> <u>H</u>				

CÓDIGO	W	LM	K	TIPO	VERSIÓN		ELECTRÓNICA	PVP
62900	3w	240Lm	2700K	<u>E</u>	<u>R</u> Redondo	<u>O</u> Opal	ON/OFF	19,95€
62901	3w	250Lm	3000K		<u>C</u> Cuadrado			
62902	3w	260Lm	4000K					

ZIRCON



IP 54



IK 07

100-265V 50/60Hz

Alu

Glass Cover



CE

3

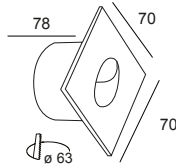
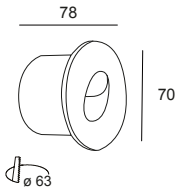

CÓDIGO	W	LM	K	VERSIÓN	ÓPTICA°	Ra/CRI			L	W	H	PVP
60200	3w	285Lm	3000K	Redondo	60	>80	-20+60	B	70	78	63	42,90€
60201	3w	300Lm	4000K	Redondo	60	>80	-20+60	B	70	78	63	42,90€
60203	3w	285Lm	3000K	Cuadrado	60	>80	-20+60	B	70	70	78	42,90€
60204	3w	300Lm	4000K	Cuadrado	60	>80	-20+60	B	70	70	78	42,90€

SAPPHIRE



IP 54



IK 07

100-265V 50/60Hz

Alu

Glass Cover



CE

3

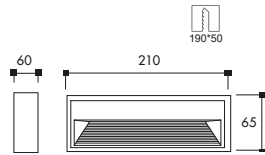
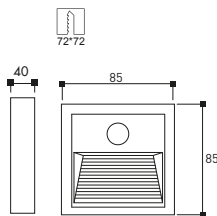
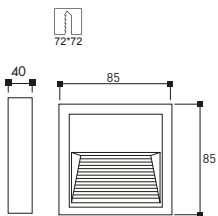

CÓDIGO	W	LM	K	VERSIÓN	ÓPTICA°	Ra/CRI			L	W	H	PVP	
60206	3w	285Lm	3000K	Cuadrado	90	>80	-20+60	A	85	85	40	72*72	42,90€
60207	3w	300Lm	4000K	Cuadrado	90	>80	-20+60	A	85	85	40	72*72	42,90€
60209	3w	285Lm	3000K	Cuadrado con sensor	90	>80	-20+60	A	85	85	40	72*72	61,40€
60210	3w	300Lm	4000K	Cuadrado con sensor	90	>80	-20+60	A	85	85	40	72*72	61,40€
60212	5w	475Lm	3000K	Rectangular	60	>80	-20+60	A	210	65	60	190*50	61,40€
60213	5w	500Lm	4000K	Rectangular	60	>80	-20+60	A	210	65	60	190*50	61,40€

YUE

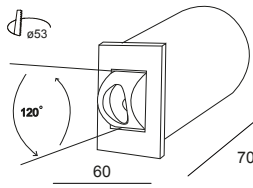
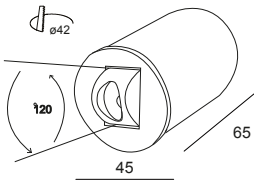
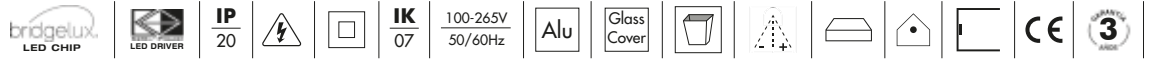

CÓDIGO	W	LM	K	VERSIÓN	ÓPTICA°	Ra/CRI			L	W	H	PVP
60221	3w	285Lm	3000K	Redondo	30	>80	-20+60		45	65	42	49,95€
60222	3w	300Lm	4000K	Redondo	30	>80	-20+60		45	65	42	49,95€
60224	3w	285Lm	3000K	Cuadrado	30	>80	-20+60		60	60	70	49,95€
60225	3w	300Lm	4000K	Cuadrado	30	>80	-20+60		60	60	70	49,95€

AYLA

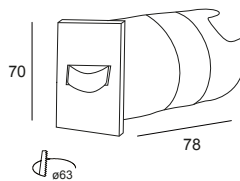
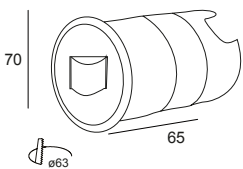
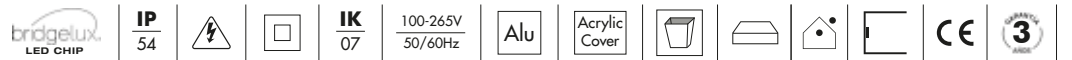

CÓDIGO	W	LM	K	VERSIÓN	ÓPTICA°	Ra/CRI			L	W	H	PVP
60215	3w	285Lm	3000K	Redondo	10	>80	-20+60		70	78	63	47,20€
60216	3w	300Lm	4000K	Redondo	10	>80	-20+60		70	78	63	47,20€
60218	3w	285Lm	3000K	Cuadrado	10	>80	-20+60		70	70	78	47,20€
60219	3w	300Lm	4000K	Cuadrado	10	>80	-20+60		70	70	78	47,20€



LYOPRO
LEVEL

**APLIQUES DE INTERIOR
INDOOR APPLIANCES
APPAREILS D'INTÉRIEUR**

NELLA



IP 20



100-265V
50/60Hz

Alu

Acrylic Cover



CE

3

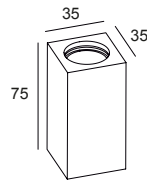

CÓDIGO	W	LM	K	ÓPTICA°	Ra/CRI	°C	Color	L	W	H	PVP
60800	2w	190Lm	3000K	60	>80	-20+50	B	35	35	75	27,85€
60801	2w	200Lm	4000K	60	>80	-20+50	B	35	35	75	27,85€

AZAI



IP 20



100-265V
50/60Hz

Alu

Acrylic Cover



CE

3



1W



2x1W

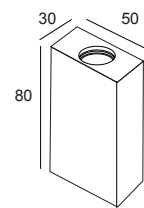
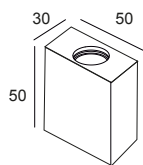

CÓDIGO	W	LM	K	ÓPTICA°	Ra/CRI	°C	Color	L	W	H	PVP
60803	1w	95Lm	3000K	60	>80	-20+50	B	50	30	50	21,40€
60804	1w	100Lm	4000K	60	>80	-20+50	B	50	30	50	21,40€
60806	2x1w	190Lm	3000K	60	>80	-20+50	B	50	30	80	30,00€
60807	2x1w	200Lm	4000K	60	>80	-20+50	B	50	30	80	30,00€

KERR



IP 54



220-240V
50/60Hz

Alu

Acrylic Cover



CE

3



60° ADJUSTABLE BEAM ANGLE 0°

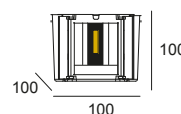
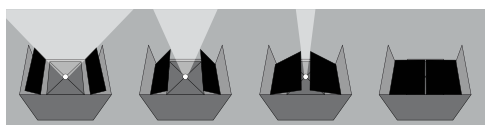

CÓDIGO	W	LM	K	ÓPTICA°	Ra/CRI	°C	Color	L	W	H	PVP
60848	6w	570Lm	3000K	0-60	>80	-20+60	B	100	100	100	64,95€
60849	6w	600Lm	4000K	0-60	>80	-20+60	B	100	100	100	64,95€

JULIA



IP 54



220-240V
50/60Hz

Alu

Acrylic
Cover



CE

3



3W

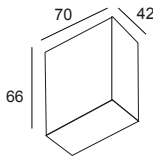

2x3W

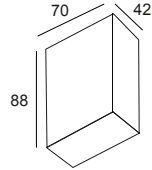

CÓDIGO	W	LM	K	ÓPTICA°	Ra/CRI			L	W	H	PVP
60827	3w	285Lm	3000K	60	>80	-20+60	A	70	42	66	53,65€
60828	3w	300Lm	4000K	60	>80	-20+60	A	70	42	66	53,65€
60830	2x3w	570Lm	3000K	60	>80	-20+60	A	70	42	88	64,40€
60831	2x3w	600Lm	4000K	60	>80	-20+60	A	70	42	88	64,40€

RHODA



IP 54



220-240V
50/60Hz

Alu

Acrylic
Cover



CE

3



3W

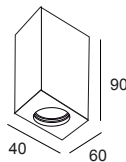

2x3W

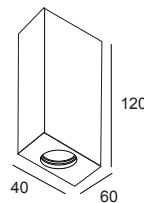

CÓDIGO	W	LM	K	ÓPTICA°	Ra/CRI			L	W	H	PVP
60833	3w	285Lm	3000K	60	>80	-20+60	A	40	60	90	53,65€
60834	3w	300Lm	4000K	60	>80	-20+60	A	40	60	90	53,65€
60836	2x3w	570Lm	3000K	10-60	>80	-20+60	A	40	60	120	64,40€
60837	2x3w	600Lm	4000K	10-60	>80	-20+60	A	40	60	120	64,40€
60839	2x3w	570Lm	3000K	60-60	>80	-20+60	A	40	60	120	64,40€
60840	2x3w	600Lm	4000K	60-60	>80	-20+60	A	40	60	120	64,40€

HELENA

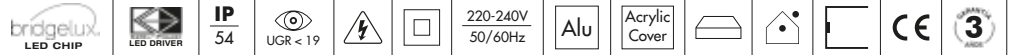

3W

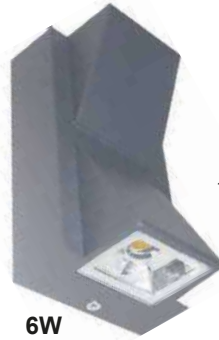
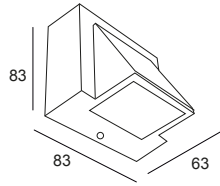

6W

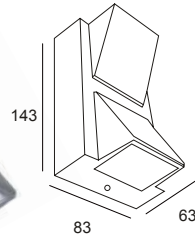

CÓDIGO	W	LM	K	ÓPTICA°	Ra/CRI	°C	Color	L	W	H	PVP
60813	3w	300Lm	4000K	60	>80	-20+60	A	83	63	83	37,95€
60816	6w	600Lm	4000K	60	>80	-20+60	A	83	63	143	46,95€

KON

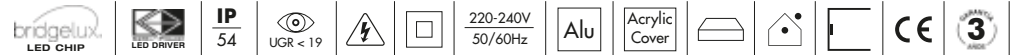

4W

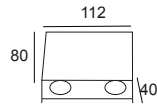

6W

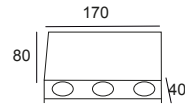

8W

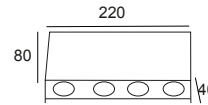
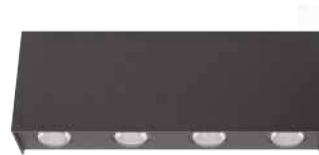

CÓDIGO	W	LM	K	ÓPTICA°	Ra/CRI	°C	Color	L	W	H	PVP
60819	4w	400Lm	4000K	60	>80	-20+60	A	112	40	80	46,95€
60822	6w	600Lm	4000K	60	>80	-20+60	A	170	40	80	57,95€
60825	8w	800Lm	4000K	60	>80	-20+60	A	220	40	80	69,95€

BENOR

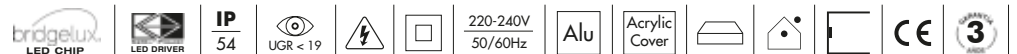

3W

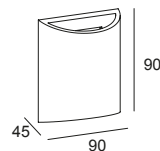

6W

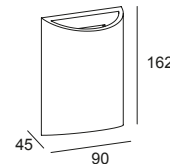

CÓDIGO	W	LM	K	ÓPTICA°	Ra/CRI	°C	Color	L	W	H	PVP
60842	3w	285Lm	3000K	60	>80	-20+60	A	90	45	90	53,65€
60843	3w	300Lm	4000K	60	>80	-20+60	A	90	45	90	53,65€
60845	6w	570Lm	3000K	60	>80	-20+60	A	90	45	162	81,60€
60846	6w	600Lm	4000K	60	>80	-20+60	A	90	45	162	81,60€

NOGA

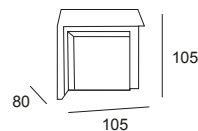
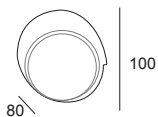
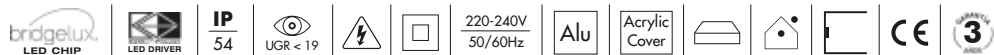

CÓDIGO	W	LM	K	ÓPTICA°	Ra/CRI			VERSIÓN				PVP
									L	W	H	
60852	6w	600Lm	4000K	120	>80	-20+60	A	Redondo	100	80		64,40€
60855	6w	600Lm	4000K	120	>80	-20+60	A	Cuadrado	105	105	80	64,40€

MEIRA

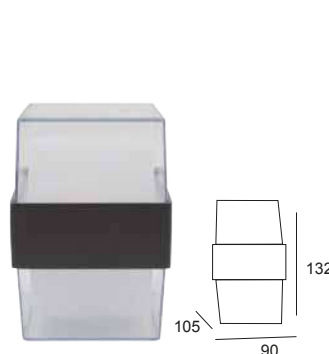
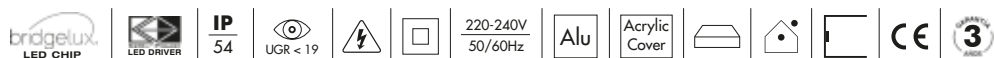

CÓDIGO	W	LM	K	ÓPTICA°	Ra/CRI			VERSIÓN				PVP
									L	W	H	
60858	6w	600Lm	4000K	180	>80	-20+60	A	Redondo	90	105	132	69,95€
60861	6w	600Lm	4000K	180	>80	-20+60	A	Cuadrado	90	105	132	69,95€

ELINA

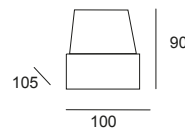
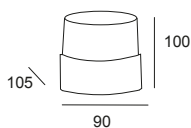
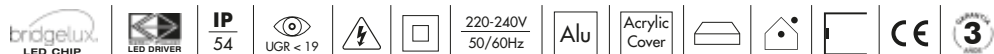

CÓDIGO	W	LM	K	ÓPTICA°	Ra/CRI			VERSIÓN				PVP
									L	W	H	
60864	3w	300Lm	4000K	180	>80	-20+60	A	Redondo	90	105	100	47,95€
60867	3w	300Lm	4000K	180	>80	-20+60	A	Cuadrado	100	105	90	47,95€

ADHAR



IP 54



100-265V
50/60Hz

Alu

Acrylic
Cover

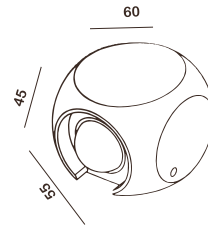

CÓDIGO	W	LM	K	ÓPTICA°	Ra/CRI	°C	Color	L	W	H	PVP
60869	2x1w	190Lm	3000K	60	>80	-20+60	B <input type="checkbox"/>	55	45	60	36,95€
60870	2x1w	200Lm	4000K	60	>80	-20+60	B <input type="checkbox"/>	55	45	60	36,95€

NARA



IP 54



100-265V
50/60Hz

Alu

Acrylic
Cover

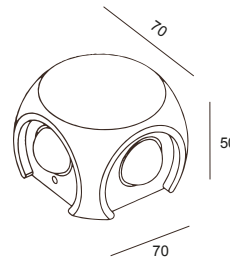

CÓDIGO	W	LM	K	ÓPTICA°	Ra/CRI	°C	Color	L	W	H	PVP
60872	4x1w	380Lm	3000K	60	>80	-20+60	B <input type="checkbox"/>	70	50	70	39,95€
60873	4x1w	400Lm	4000K	60	>80	-20+60	B <input type="checkbox"/>	70	50	70	39,95€

KARNI



IP 54



220-240V
50/60Hz

Alu

Acrylic
Cover

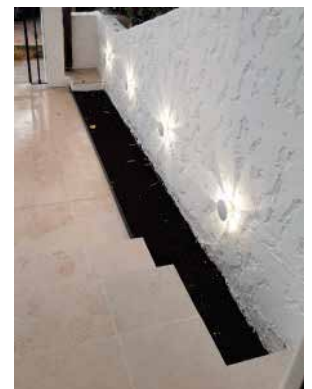
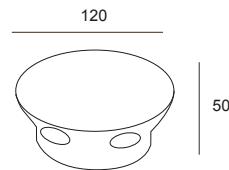

CÓDIGO	W	LM	K	ÓPTICA°	Ra/CRI	°C	Color	L	W	H	PVP
60876	5x1w	500Lm	4000K	60	>80	-20+60	B <input type="checkbox"/>	120		50	64,40€

MAOR

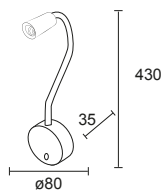
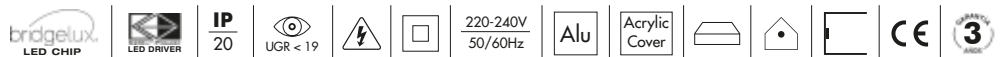

CÓDIGO	W	LM	K	ÓPTICA°	Ra/CRI			L	W	H	PVP
60878	3w	285Lm	3000K	60	>80	-20+60	B <input type="checkbox"/>	80	35	430	49,95€
60879	3w	300Lm	4000K	60	>80	-20+60	B <input type="checkbox"/>	80	35	430	49,95€

JATA

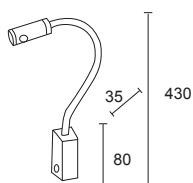
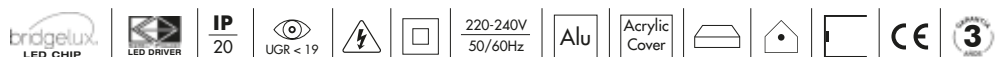

CÓDIGO	W	LM	K	ÓPTICA°	Ra/CRI			L	W	H	PVP
60881	3w	285Lm	3000K	24	>80	-20+60	B <input type="checkbox"/>	80	35	430	49,95€
60882	3w	300Lm	4000K	24	>80	-20+60	B <input type="checkbox"/>	80	35	430	49,95€

DESA

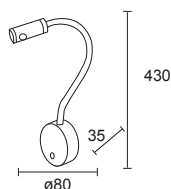
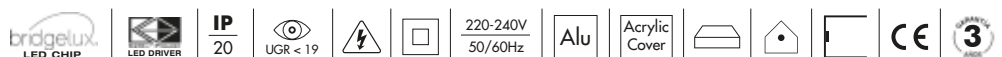

CÓDIGO	W	LM	K	ÓPTICA°	Ra/CRI			L	W	H	PVP
60884	3w	285Lm	3000K	24	>80	-20+60	B <input type="checkbox"/>	80	35	430	49,95€
60885	3w	300Lm	4000K	24	>80	-20+60	B <input type="checkbox"/>	80	35	430	49,95€

ESTELA

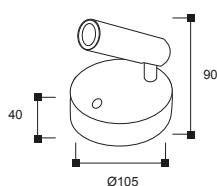
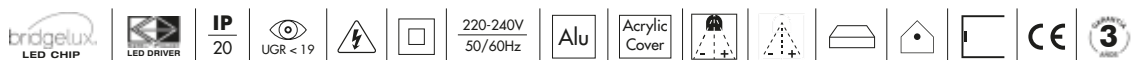

CÓDIGO	W	LM	K	ÓPTICA°	Ra/CRI			L	H	PVP
60887	3w	285Lm	3000K	60	>80	-20+60	B <input type="checkbox"/>	105	90	54,95€
60888	3w	300Lm	4000K	60	>80	-20+60	B <input type="checkbox"/>	105	90	54,95€

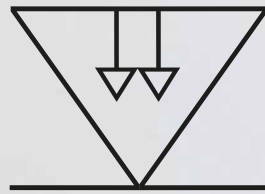
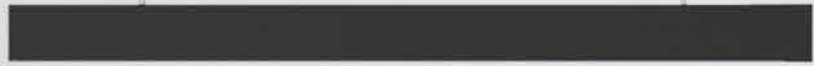

LYOPRO
LEVEL



LUMINARIA LINEAL
LINEAR LUMINAIRE
LUMINAIRE LINÉAIRE



2700 - 3000 - 4000K



Available in November 23

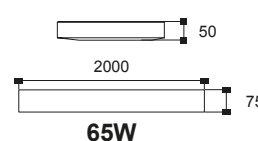
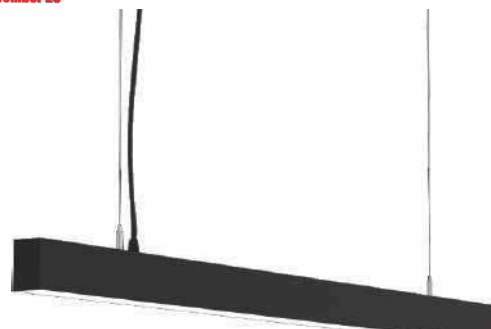
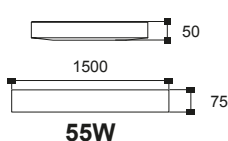
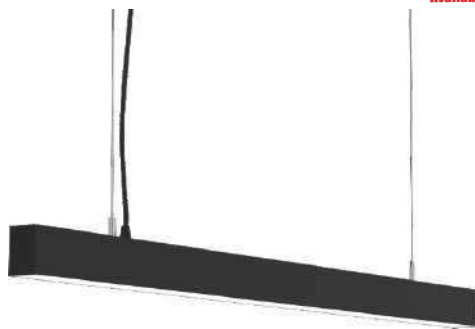
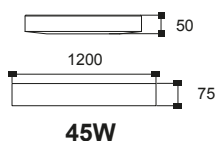

*Suspension kit 1.5 meters included - *Electrical cable 1.6 meters included

CÓDIGO	W	LM	K	ÓPTICA°		UGR		L	W	H	ELECTRÓNICA	PVP
63170	45w	4950Lm	3 CCT	120	B <input type="checkbox"/>	>19	-20+45	1200	50	75	ON/OFF	119,95€
63171	45w	4950Lm	3 CCT	120	N <input checked="" type="checkbox"/>	>19	-20+45	1200	50	75	ON/OFF	119,95€
63172	55w	6250Lm	3 CCT	120	B <input type="checkbox"/>	>19	-20+45	1500	50	75	ON/OFF	159,95€
63173	55w	6250Lm	3 CCT	120	N <input checked="" type="checkbox"/>	>19	-20+45	1500	50	75	ON/OFF	159,95€
63174	65w	7750Lm	3 CCT	120	B <input type="checkbox"/>	>19	-20+45	2000	50	75	ON/OFF	189,95€
63175	65w	7750Lm	3 CCT	120	N <input checked="" type="checkbox"/>	>19	-20+45	2000	50	75	ON/OFF	189,95€



CÓDIGO	W	LM	K	ÓPTICA°		UGR		L	W	H	PVP
63180	8w	960Lm	3 CCT	120	B <input type="checkbox"/>	>19	-20+45	150x150	50	75	69,95€
63181	8w	960Lm	3 CCT	120	N <input checked="" type="checkbox"/>	>19	-20+45	150x150	50	75	69,95€

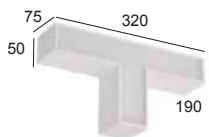

CÓDIGO	W	LM	K	ÓPTICA°		UGR		L	W	H	PVP
63182	45w	4950Lm	3 CCT	120	B <input type="checkbox"/>	>19	-20+45	190x320	50	75	89,95€
63183	45w	4950Lm	3 CCT	120	N <input checked="" type="checkbox"/>	>19	-20+45	190x320	50	75	89,95€

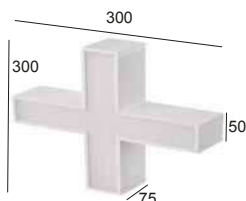

CÓDIGO	W	LM	K	ÓPTICA°		UGR		L	W	H	PVP
63184	45w	4950Lm	3 CCT	120	B <input type="checkbox"/>	>19	-20+45	300x300	50	75	99,95€
63185	45w	4950Lm	3 CCT	120	N <input checked="" type="checkbox"/>	>19	-20+45	300x300	50	75	99,95€



CÓDIGO	DESCRIPCIÓN	PVP
63190	Kit unión mecánica (4 uniones)	3,25€

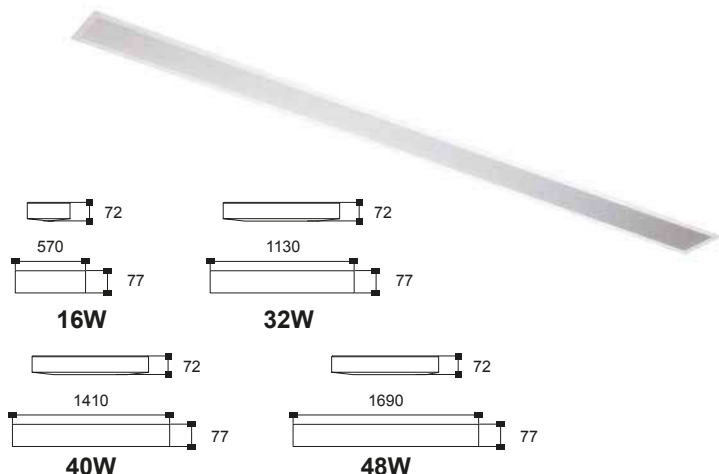

CÓDIGO	W	LM	K	ÓPTICA°	°C	VERSIÓN	ELECTRÓNICA	L W H			PVP	
								L	W	H		
10383101077DD	16w	1520Lm	3000K	120	0+35	Empotrar	B	ON/OFF	570	77	72	183,48€
10383201077DD	16w	1520Lm	3000K	120	0+35	Empotrar	G	ON/OFF	570	77	72	187,59€
10383301077DD	16w	1520Lm	3000K	120	0+35	Empotrar	N	ON/OFF	570	77	72	203,30€
10383181077DD	16w	1520Lm	3000K	120	0+35	Empotrar	B	DALI	570	77	72	218,48€
10383281077DD	16w	3040Lm	3000K	120	0+35	Empotrar	G	DALI	570	77	72	222,74€
10383381077DD	16w	3040Lm	3000K	120	0+35	Empotrar	N	DALI	570	77	72	238,30€
10383102077DD	32w	3040Lm	3000K	120	0+35	Empotrar	B	ON/OFF	1130	77	72	222,78€
10383202077DD	32w	3040Lm	3000K	120	0+35	Empotrar	G	ON/OFF	1130	77	72	228,93€
10383302077DD	32w	3040Lm	3000K	120	0+35	Empotrar	N	ON/OFF	1130	77	72	242,59€
10383182077DD	32w	3040Lm	3000K	120	0+35	Empotrar	B	DALI	1130	77	72	282,44€
10383282077DD	32w	3800Lm	3000K	120	0+35	Empotrar	G	DALI	1130	77	72	288,89€
10383382077DD	32w	3800Lm	3000K	120	0+35	Empotrar	N	DALI	1130	77	72	302,26€
10383104177DD	40w	3800Lm	3000K	120	0+35	Empotrar	B	ON/OFF	1410	77	72	269,41€
10383204177DD	40w	3800Lm	3000K	120	0+35	Empotrar	G	ON/OFF	1410	77	72	277,63€
10383304177DD	40w	3800Lm	3000K	120	0+35	Empotrar	N	ON/OFF	1410	77	72	289,22€
10383184177DD	40w	3800Lm	3000K	120	0+35	Empotrar	B	DALI	1410	77	72	331,11€
10383284177DD	40w	4560Lm	3000K	120	0+35	Empotrar	G	DALI	1410	77	72	339,67€
10383384177DD	40w	4560Lm	3000K	120	0+35	Empotrar	N	DALI	1410	77	72	350,93€
10383103077DD	48w	4560Lm	3000K	120	0+35	Empotrar	B	ON/OFF	1690	77	72	277,96€
10383203077DD	48w	4560Lm	3000K	120	0+35	Empotrar	G	ON/OFF	1690	77	72	286,15€
10383303077DD	48w	4560Lm	3000K	120	0+35	Empotrar	N	ON/OFF	1690	77	72	297,78€
10383183077DD	48w	4560Lm	3000K	120	0+35	Empotrar	B	DALI	1690	77	72	340,04€
10383283077DD	48w	4560Lm	3000K	120	0+35	Empotrar	G	DALI	1690	77	72	348,59€
10383383077DD	48w	4560Lm	3000K	120	0+35	Empotrar	N	DALI	1690	77	72	359,85€
10384101077DD	16w	1520Lm	4000K	120	0+35	Empotrar	B	ON/OFF	570	77	72	183,48€
10384201077DD	16w	1520Lm	4000K	120	0+35	Empotrar	G	ON/OFF	570	77	72	187,59€
10384301077DD	16w	1520Lm	4000K	120	0+35	Empotrar	N	ON/OFF	570	77	72	203,30€
10384181077DD	16w	1520Lm	4000K	120	0+35	Empotrar	B	DALI	570	77	72	218,48€
10384281077DD	16w	3040Lm	4000K	120	0+35	Empotrar	G	DALI	570	77	72	222,74€
10384381077DD	16w	3040Lm	4000K	120	0+35	Empotrar	N	DALI	570	77	72	238,30€
10384102077DD	32w	3040Lm	4000K	120	0+35	Empotrar	B	ON/OFF	1130	77	72	222,78€
10384202077DD	32w	3040Lm	4000K	120	0+35	Empotrar	G	ON/OFF	1130	77	72	228,93€
10384302077DD	32w	3040Lm	4000K	120	0+35	Empotrar	N	ON/OFF	1130	77	72	242,59€
10384182077DD	32w	3040Lm	4000K	120	0+35	Empotrar	B	DALI	1130	77	72	282,44€
10384282077DD	32w	3800Lm	4000K	120	0+35	Empotrar	G	DALI	1130	77	72	288,89€
10384382077DD	32w	3800Lm	4000K	120	0+35	Empotrar	N	DALI	1130	77	72	302,26€
10384104177DD	40w	3800Lm	4000K	120	0+35	Empotrar	B	ON/OFF	1410	77	72	269,41€
10384204177DD	40w	3800Lm	4000K	120	0+35	Empotrar	G	ON/OFF	1410	77	72	277,63€
10384304177DD	40w	3800Lm	4000K	120	0+35	Empotrar	N	ON/OFF	1410	77	72	289,22€
10384184177DD	40w	3800Lm	4000K	120	0+35	Empotrar	B	DALI	1410	77	72	331,11€
10384284177DD	40w	4560Lm	4000K	120	0+35	Empotrar	G	DALI	1410	77	72	339,67€
10384384177DD	40w	4560Lm	4000K	120	0+35	Empotrar	N	DALI	1410	77	72	350,93€
10384103077DD	48w	4560Lm	4000K	120	0+35	Empotrar	B	ON/OFF	1690	77	72	277,96€
10384203077DD	48w	4560Lm	4000K	120	0+35	Empotrar	G	ON/OFF	1690	77	72	286,15€
10384303077DD	48w	4560Lm	4000K	120	0+35	Empotrar	N	ON/OFF	1690	77	72	297,78€
10384183077DD	48w	4560Lm	4000K	120	0+35	Empotrar	B	DALI	1690	77	72	340,04€
10384283077DD	48w	4560Lm	4000K	120	0+35	Empotrar	G	DALI	1690	77	72	348,59€
10384383077DD	48w	4560Lm	4000K	120	0+35	Empotrar	N	DALI	1690	77	72	359,85€

* Accesorios SIMA pag. 107

* Otras temperaturas de color a consultar.

* Otros acabados a consultar.

* Tapas y uniones sin cargo (para formar líneas continuas, indicar en el pedido: PRINCIPIO, INTERMEDIO, FINAL).

* Por defecto se suministrara en formato individual.

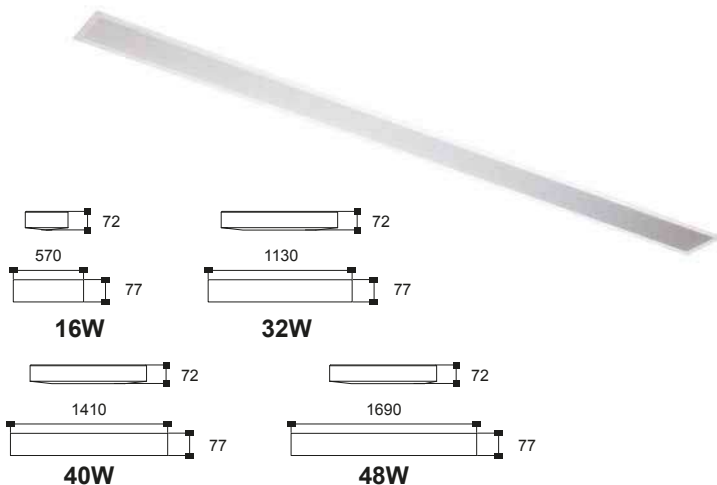

CÓDIGO	W	LM	K	ÓPTICA°		VERSIÓN		ELECTRÓNICA				PVP
									L	W	H	
10383101077DMP	16w	1680Lm	3000K	100	0+35	Empotrar	B	ON/OFF	570	77	72	191,67€
10383201077DMP	16w	1680Lm	3000K	100	0+35	Empotrar	G	ON/OFF	570	77	72	195,78€
10383301077DMP	16w	1680Lm	3000K	100	0+35	Empotrar	N	ON/OFF	570	77	72	211,48€
10383181077DMP	16w	1680Lm	3000K	100	0+35	Empotrar	B	DALI	570	77	72	227,04€
10383281077DMP	16w	1680Lm	3000K	100	0+35	Empotrar	G	DALI	570	77	72	231,30€
10383381077DMP	16w	1680Lm	3000K	100	0+35	Empotrar	N	DALI	570	77	72	246,85€
10383102077DMP	32w	3360Lm	3000K	100	0+35	Empotrar	B	ON/OFF	1130	77	72	239,19€
10383202077DMP	32w	3360Lm	3000K	100	0+35	Empotrar	G	ON/OFF	1130	77	72	245,33€
10383302077DMP	32w	3360Lm	3000K	100	0+35	Empotrar	N	ON/OFF	1130	77	72	259,00€
10383182077DMP	32w	3360Lm	3000K	100	0+35	Empotrar	B	DALI	1130	77	72	299,59€
10383282077DMP	32w	3360Lm	3000K	100	0+35	Empotrar	G	DALI	1130	77	72	306,00€
10383382077DMP	32w	3360Lm	3000K	100	0+35	Empotrar	N	DALI	1130	77	72	319,41€
10383104177DMP	40w	4200Lm	3000K	100	0+35	Empotrar	B	ON/OFF	1410	77	72	289,93€
10383204177DMP	40w	4200Lm	3000K	100	0+35	Empotrar	G	ON/OFF	1410	77	72	298,11€
10383304177DMP	40w	4200Lm	3000K	100	0+35	Empotrar	N	ON/OFF	1410	77	72	309,74€
10383184177DMP	40w	4200Lm	3000K	100	0+35	Empotrar	B	DALI	1410	77	72	352,52€
10383284177DMP	40w	4200Lm	3000K	100	0+35	Empotrar	G	DALI	1410	77	72	361,07€
10383384177DMP	40w	4200Lm	3000K	100	0+35	Empotrar	N	DALI	1410	77	72	372,33€
10383103077DMP	48w	5400Lm	3000K	100	0+35	Empotrar	B	ON/OFF	1690	77	72	302,56€
10383203077DMP	48w	5400Lm	3000K	100	0+35	Empotrar	G	ON/OFF	1690	77	72	310,78€
10383303077DMP	48w	5400Lm	3000K	100	0+35	Empotrar	N	ON/OFF	1690	77	72	322,37€
10383183077DMP	48w	5400Lm	3000K	100	0+35	Empotrar	B	DALI	1690	77	72	365,70€
10383283077DMP	48w	5400Lm	3000K	100	0+35	Empotrar	G	DALI	1690	77	72	375,67€
10383383077DMP	48w	5400Lm	3000K	100	0+35	Empotrar	N	DALI	1690	77	72	385,52€
10384101077DMP	16w	1680Lm	4000K	100	0+35	Empotrar	B	ON/OFF	570	77	72	191,67€
10384201077DMP	16w	1680Lm	4000K	100	0+35	Empotrar	G	ON/OFF	570	77	72	195,78€
10384301077DMP	16w	1680Lm	4000K	100	0+35	Empotrar	N	ON/OFF	570	77	72	211,48€
10384181077DMP	16w	1680Lm	4000K	100	0+35	Empotrar	B	DALI	570	77	72	227,04€
10384281077DMP	16w	1680Lm	4000K	100	0+35	Empotrar	G	DALI	570	77	72	231,30€
10384381077DMP	16w	1680Lm	4000K	100	0+35	Empotrar	N	DALI	570	77	72	246,85€
10384102077DMP	32w	3360Lm	4000K	100	0+35	Empotrar	B	ON/OFF	1130	77	72	239,19€
10384202077DMP	32w	3360Lm	4000K	100	0+35	Empotrar	G	ON/OFF	1130	77	72	245,33€
10384302077DMP	32w	3360Lm	4000K	100	0+35	Empotrar	N	ON/OFF	1130	77	72	259,00€
10384182077DMP	32w	3360Lm	4000K	100	0+35	Empotrar	B	DALI	1130	77	72	299,59€
10384282077DMP	32w	3360Lm	4000K	100	0+35	Empotrar	G	DALI	1130	77	72	306,00€
10384382077DMP	32w	3360Lm	4000K	100	0+35	Empotrar	N	DALI	1130	77	72	319,41€
10384104177DMP	40w	4200Lm	4000K	100	0+35	Empotrar	B	ON/OFF	1410	77	72	289,93€
10384204177DMP	40w	4200Lm	4000K	100	0+35	Empotrar	G	ON/OFF	1410	77	72	298,11€
10384304177DMP	40w	4200Lm	4000K	100	0+35	Empotrar	N	ON/OFF	1410	77	72	309,74€
10384184177DMP	40w	4200Lm	4000K	100	0+35	Empotrar	B	DALI	1410	77	72	352,52€
10384284177DMP	40w	4200Lm	4000K	100	0+35	Empotrar	G	DALI	1410	77	72	361,07€
10384384177DMP	40w	4200Lm	4000K	100	0+35	Empotrar	N	DALI	1410	77	72	372,33€
10384103077DMP	48w	5400Lm	4000K	100	0+35	Empotrar	B	ON/OFF	1690	77	72	302,56€
10384203077DMP	48w	5400Lm	4000K	100	0+35	Empotrar	G	ON/OFF	1690	77	72	310,78€
10384303077DMP	48w	5400Lm	4000K	100	0+35	Empotrar	N	ON/OFF	1690	77	72	322,37€
10384183077DMP	48w	5400Lm	4000K	100	0+35	Empotrar	B	DALI	1690	77	72	365,70€
10384283077DMP	48w	5400Lm	4000K	100	0+35	Empotrar	G	DALI	1690	77	72	375,67€
10384383077DMP	48w	5400Lm	4000K	100	0+35	Empotrar	N	DALI	1690	77	72	385,52€

* Accesorios SIMA pag. 107

* Otras temperaturas de color a consultar.

* Otros acabados a consultar.

* Tapas y uniones sin cargo (para formar líneas continuas, indicar en el pedido: PRINCIPIO, INTERMEDIO, FINAL).

* Por defecto se suministrara en formato individual.

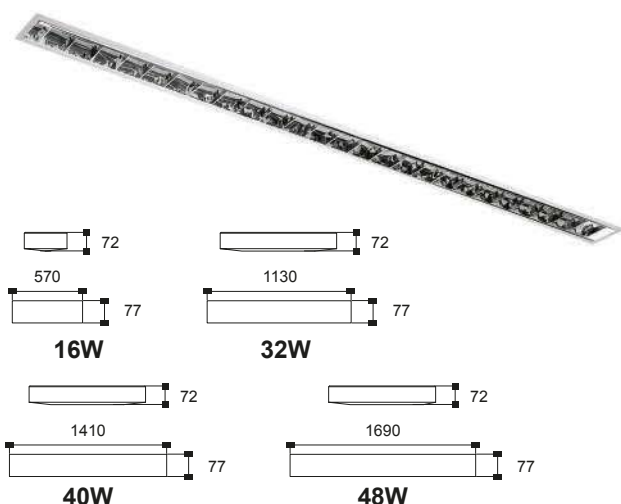

CÓDIGO	W	LM	K	ÓPTICA°		VERSIÓN		ELECTRÓNICA				PVP
									L	W	H	
10383101077COV	16w	1568Lm	3000K	90	0+35	Empotrar	B <input type="checkbox"/>	ON/OFF	570	77	72	228,59€
10383201077COV	16w	1568Lm	3000K	90	0+35	Empotrar	G <input type="checkbox"/>	ON/OFF	570	77	72	232,70€
10383301077COV	16w	1568Lm	3000K	90	0+35	Empotrar	N <input type="checkbox"/>	ON/OFF	570	77	72	248,41€
10383181077COV	16w	1568Lm	3000K	90	0+35	Empotrar	B <input type="checkbox"/>	DALI	570	77	72	265,56€
10383281077COV	16w	1568Lm	3000K	90	0+35	Empotrar	G <input type="checkbox"/>	DALI	570	77	72	269,81€
10383381077COV	16w	1568Lm	3000K	90	0+35	Empotrar	N <input type="checkbox"/>	DALI	570	77	72	285,37€
10383102077COV	32w	3136Lm	3000K	90	0+35	Empotrar	B <input type="checkbox"/>	ON/OFF	1130	77	72	267,89€
10383202077COV	32w	3136Lm	3000K	90	0+35	Empotrar	G <input type="checkbox"/>	ON/OFF	1130	77	72	274,04€
10383302077COV	32w	3136Lm	3000K	90	0+35	Empotrar	N <input type="checkbox"/>	ON/OFF	1130	77	72	287,70€
10383182077COV	32w	3136Lm	3000K	90	0+35	Empotrar	B <input type="checkbox"/>	DALI	1130	77	72	329,56€
10383282077COV	32w	3136Lm	3000K	90	0+35	Empotrar	G <input type="checkbox"/>	DALI	1130	77	72	335,96€
10383382077COV	32w	3136Lm	3000K	90	0+35	Empotrar	N <input type="checkbox"/>	DALI	1130	77	72	349,37€
10383104177COV	40w	3920Lm	3000K	90	0+35	Empotrar	B <input type="checkbox"/>	ON/OFF	1410	77	72	316,59€
10383204177COV	40w	3920Lm	3000K	90	0+35	Empotrar	G <input type="checkbox"/>	ON/OFF	1410	77	72	324,78€
10383304177COV	40w	3920Lm	3000K	90	0+35	Empotrar	N <input type="checkbox"/>	ON/OFF	1410	77	72	336,41€
10383184177COV	40w	3920Lm	3000K	90	0+35	Empotrar	B <input type="checkbox"/>	DALI	1410	77	72	380,33€
10383284177COV	40w	3920Lm	3000K	90	0+35	Empotrar	G <input type="checkbox"/>	DALI	1410	77	72	388,89€
10383384177COV	40w	3920Lm	3000K	90	0+35	Empotrar	N <input type="checkbox"/>	DALI	1410	77	72	400,15€
10383103077COV	48w	4704Lm	3000K	90	0+35	Empotrar	B <input type="checkbox"/>	ON/OFF	1690	77	72	341,52€
10383203077COV	48w	4704Lm	3000K	90	0+35	Empotrar	G <input type="checkbox"/>	ON/OFF	1690	77	72	349,74€
10383303077COV	48w	4704Lm	3000K	90	0+35	Empotrar	N <input type="checkbox"/>	ON/OFF	1690	77	72	361,33€
10383183077COV	48w	4704Lm	3000K	90	0+35	Empotrar	B <input type="checkbox"/>	DALI	1690	77	72	406,37€
10383283077COV	48w	4704Lm	3000K	90	0+35	Empotrar	G <input type="checkbox"/>	DALI	1690	77	72	414,93€
10383383077COV	48w	4704Lm	3000K	90	0+35	Empotrar	N <input type="checkbox"/>	DALI	1690	77	72	426,19€
10384101077COV	16w	1568Lm	4000K	90	0+35	Empotrar	B <input type="checkbox"/>	ON/OFF	570	77	72	228,59€
10384201077COV	16w	1568Lm	4000K	90	0+35	Empotrar	G <input type="checkbox"/>	ON/OFF	570	77	72	232,70€
10384301077COV	16w	1568Lm	4000K	90	0+35	Empotrar	N <input type="checkbox"/>	ON/OFF	570	77	72	248,41€
10384181077COV	16w	1568Lm	4000K	90	0+35	Empotrar	B <input type="checkbox"/>	DALI	570	77	72	265,56€
10384281077COV	16w	1568Lm	4000K	90	0+35	Empotrar	G <input type="checkbox"/>	DALI	570	77	72	269,81€
10384381077COV	16w	1568Lm	4000K	90	0+35	Empotrar	N <input type="checkbox"/>	DALI	570	77	72	285,37€
10384102077COV	32w	3136Lm	4000K	90	0+35	Empotrar	B <input type="checkbox"/>	ON/OFF	1130	77	72	267,89€
10384202077COV	32w	3136Lm	4000K	90	0+35	Empotrar	G <input type="checkbox"/>	ON/OFF	1130	77	72	274,04€
10384302077COV	32w	3136Lm	4000K	90	0+35	Empotrar	N <input type="checkbox"/>	ON/OFF	1130	77	72	287,70€
10384182077COV	32w	3136Lm	4000K	90	0+35	Empotrar	B <input type="checkbox"/>	DALI	1130	77	72	329,56€
10384282077COV	32w	3136Lm	4000K	90	0+35	Empotrar	G <input type="checkbox"/>	DALI	1130	77	72	335,96€
10384382077COV	32w	3136Lm	4000K	90	0+35	Empotrar	N <input type="checkbox"/>	DALI	1130	77	72	349,37€
10384104177COV	40w	3920Lm	4000K	90	0+35	Empotrar	B <input type="checkbox"/>	ON/OFF	1410	77	72	316,59€
10384204177COV	40w	3920Lm	4000K	90	0+35	Empotrar	G <input type="checkbox"/>	ON/OFF	1410	77	72	324,78€
10384304177COV	40w	3920Lm	4000K	90	0+35	Empotrar	N <input type="checkbox"/>	ON/OFF	1410	77	72	336,41€
10384184177COV	40w	3920Lm	4000K	90	0+35	Empotrar	B <input type="checkbox"/>	DALI	1410	77	72	380,33€
10384284177COV	40w	3920Lm	4000K	90	0+35	Empotrar	G <input type="checkbox"/>	DALI	1410	77	72	388,89€
10384384177COV	40w	3920Lm	4000K	90	0+35	Empotrar	N <input type="checkbox"/>	DALI	1410	77	72	400,15€
10384103077COV	48w	4704Lm	4000K	90	0+35	Empotrar	B <input type="checkbox"/>	ON/OFF	1690	77	72	341,52€
10384203077COV	48w	4704Lm	4000K	90	0+35	Empotrar	G <input type="checkbox"/>	ON/OFF	1690	77	72	349,74€
10384303077COV	48w	4704Lm	4000K	90	0+35	Empotrar	N <input type="checkbox"/>	ON/OFF	1690	77	72	361,33€
10384183077COV	48w	4704Lm	4000K	90	0+35	Empotrar	B <input type="checkbox"/>	DALI	1690	77	72	406,37€
10384283077COV	48w	4704Lm	4000K	90	0+35	Empotrar	G <input type="checkbox"/>	DALI	1690	77	72	414,93€
10384383077COV	48w	4704Lm	4000K	90	0+35	Empotrar	N <input type="checkbox"/>	DALI	1690	77	72	426,19€

* Accesorios SIMA pag. 107

* Otras temperaturas de color a consultar.

* Otros acabados a consultar.

* Tapas y uniones sin cargo (para formar líneas continuas, indicar en el pedido: PRINCIPIO, INTERMEDIO, FINAL).

* Por defecto se suministrara en formato individual.

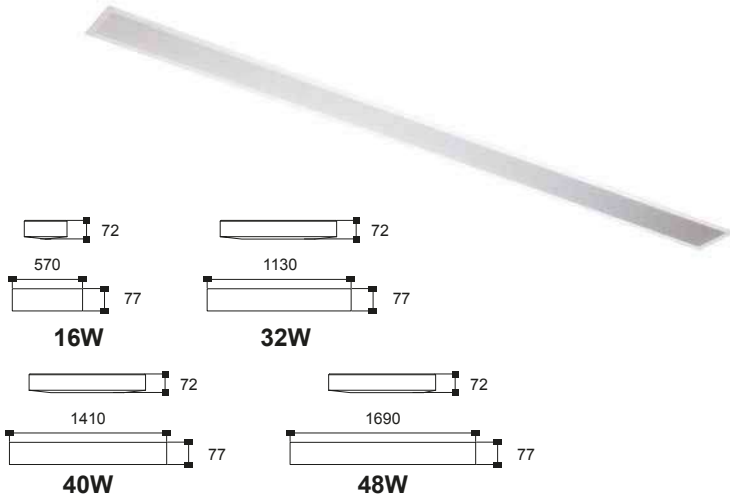

CÓDIGO	W	LM	K	ÓPTICA°		VERSIÓN		ELECTRÓNICA				PVP
									L	W	H	
103831010UGR77	12w	900Lm	3000K	90	0+35	Empotrar	B	ON/OFF	570	77	72	228,59€
103832010UGR77	12w	900Lm	3000K	90	0+35	Empotrar	G	ON/OFF	570	77	72	232,70€
103833010UGR77	12w	900Lm	3000K	90	0+35	Empotrar	N	ON/OFF	570	77	72	248,41€
103831810UGR77	12w	900Lm	3000K	90	0+35	Empotrar	B	DALI	570	77	72	265,56€
103832810UGR77	12w	900Lm	3000K	90	0+35	Empotrar	G	DALI	570	77	72	269,81€
103833810UGR77	12w	900Lm	3000K	90	0+35	Empotrar	N	DALI	570	77	72	285,37€
103831020UGR77	24w	1800Lm	3000K	90	0+35	Empotrar	B	ON/OFF	1130	77	72	276,11€
103832020UGR77	24w	1800Lm	3000K	90	0+35	Empotrar	G	ON/OFF	1130	77	72	282,26€
103833020UGR77	24w	1800Lm	3000K	90	0+35	Empotrar	N	ON/OFF	1130	77	72	295,93€
103831820UGR77	24w	1800Lm	3000K	90	0+35	Empotrar	B	DALI	1130	77	72	338,11€
103832820UGR77	24w	1800Lm	3000K	90	0+35	Empotrar	G	DALI	1130	77	72	344,52€
103833820UGR77	24w	1800Lm	3000K	90	0+35	Empotrar	N	DALI	1130	77	72	357,93€
103831041UGR77	30w	2250Lm	3000K	90	0+35	Empotrar	B	ON/OFF	1410	77	72	319,96€
103832041UGR77	30w	2250Lm	3000K	90	0+35	Empotrar	G	ON/OFF	1410	77	72	328,15€
103833041UGR77	30w	2250Lm	3000K	90	0+35	Empotrar	N	ON/OFF	1410	77	72	339,78€
103831841UGR77	30w	2250Lm	3000K	90	0+35	Empotrar	B	DALI	1410	77	72	385,22€
103832841UGR77	30w	2250Lm	3000K	90	0+35	Empotrar	G	DALI	1410	77	72	393,78€
103833841UGR77	30w	2250Lm	3000K	90	0+35	Empotrar	N	DALI	1410	77	72	405,04€
103831030UGR77	36w	2700Lm	3000K	90	0+35	Empotrar	B	ON/OFF	1690	77	72	339,15€
103832030UGR77	36w	2700Lm	3000K	90	0+35	Empotrar	G	ON/OFF	1690	77	72	347,67€
103833030UGR77	36w	2700Lm	3000K	90	0+35	Empotrar	N	ON/OFF	1690	77	72	358,96€
103831830UGR77	36w	2700Lm	3000K	90	0+35	Empotrar	B	DALI	1690	77	72	404,22€
103832830UGR77	36w	2700Lm	3000K	90	0+35	Empotrar	G	DALI	1690	77	72	412,78€
103833830UGR77	36w	2700Lm	3000K	90	0+35	Empotrar	N	DALI	1690	77	72	424,04€
103841010UGR77	12w	900Lm	4000K	90	0+35	Empotrar	B	ON/OFF	570	77	72	228,59€
103842010UGR77	12w	900Lm	4000K	90	0+35	Empotrar	G	ON/OFF	570	77	72	232,70€
103843010UGR77	12w	900Lm	4000K	90	0+35	Empotrar	N	ON/OFF	570	77	72	248,41€
103841810UGR77	12w	900Lm	4000K	90	0+35	Empotrar	B	DALI	570	77	72	265,56€
103842810UGR77	12w	900Lm	4000K	90	0+35	Empotrar	G	DALI	570	77	72	269,81€
103843810UGR77	12w	900Lm	4000K	90	0+35	Empotrar	N	DALI	570	77	72	285,37€
103841020UGR77	24w	1800Lm	4000K	90	0+35	Empotrar	B	ON/OFF	1130	77	72	276,11€
103842020UGR77	24w	1800Lm	4000K	90	0+35	Empotrar	G	ON/OFF	1130	77	72	282,26€
103843020UGR77	24w	1800Lm	4000K	90	0+35	Empotrar	N	ON/OFF	1130	77	72	295,93€
103841820UGR77	24w	1800Lm	4000K	90	0+35	Empotrar	B	DALI	1130	77	72	338,11€
103842820UGR77	24w	1800Lm	4000K	90	0+35	Empotrar	G	DALI	1130	77	72	344,52€
103843820UGR77	24w	1800Lm	4000K	90	0+35	Empotrar	N	DALI	1130	77	72	357,93€
103841041UGR77	30w	2250Lm	4000K	90	0+35	Empotrar	B	ON/OFF	1410	77	72	319,96€
103842041UGR77	30w	2250Lm	4000K	90	0+35	Empotrar	G	ON/OFF	1410	77	72	328,15€
103843041UGR77	30w	2250Lm	4000K	90	0+35	Empotrar	N	ON/OFF	1410	77	72	339,78€
103841841UGR77	30w	2250Lm	4000K	90	0+35	Empotrar	B	DALI	1410	77	72	385,22€
103842841UGR77	30w	2250Lm	4000K	90	0+35	Empotrar	G	DALI	1410	77	72	393,78€
103843841UGR77	30w	2250Lm	4000K	90	0+35	Empotrar	N	DALI	1410	77	72	405,04€
103841030UGR77	36w	2700Lm	4000K	90	0+35	Empotrar	B	ON/OFF	1690	77	72	339,15€
103842030UGR77	36w	2700Lm	4000K	90	0+35	Empotrar	G	ON/OFF	1690	77	72	347,67€
103843030UGR77	36w	2700Lm	4000K	90	0+35	Empotrar	N	ON/OFF	1690	77	72	358,96€
103841830UGR77	36w	2700Lm	4000K	90	0+35	Empotrar	B	DALI	1690	77	72	404,22€
103842830UGR77	36w	2700Lm	4000K	90	0+35	Empotrar	G	DALI	1690	77	72	412,78€
103843830UGR77	36w	2700Lm	4000K	90	0+35	Empotrar	N	DALI	1690	77	72	424,04€

* Accesorios SIMA pag. 107

* Otras temperaturas de color a consultar.

* Otros acabados a consultar.

* Tapas y uniones sin cargo (para formar líneas continuas, indicar en el pedido: PRINCIPIO, INTERMEDIO, FINAL).

* Por defecto se suministrara en formato individual.

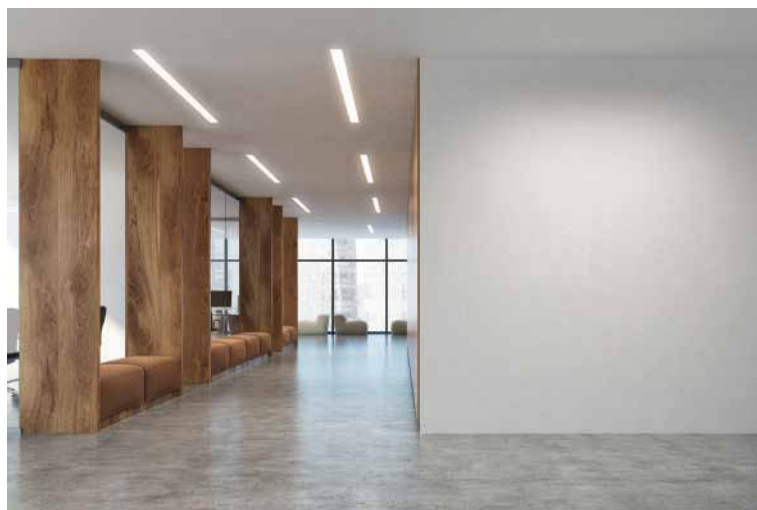
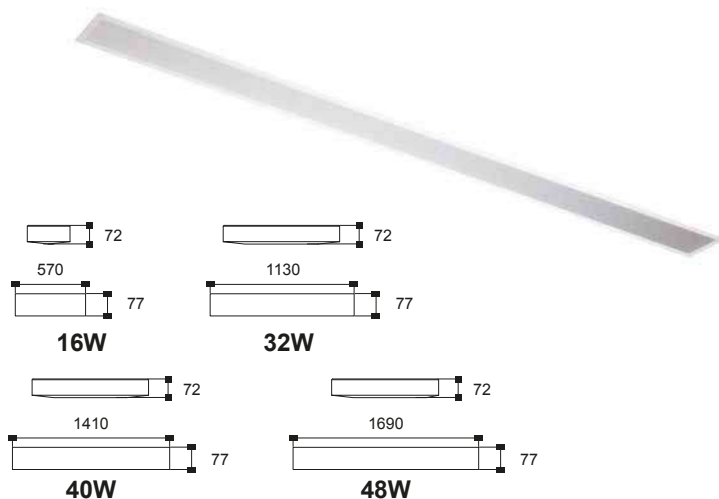

CÓDIGO	W	LM	K	ÓPTICA°		VERSIÓN		ELECTRÓNICA				PVP
									L	W	H	
10383101077ASIM	16w	2400Lm	3000K	Asimétrica	0+35	Empotrar	B	ON/OFF	570	77	72	214,93€
10383201077ASIM	16w	2400Lm	3000K	Asimétrica	0+35	Empotrar	G	ON/OFF	570	77	72	214,93€
10383301077ASIM	16w	2400Lm	3000K	Asimétrica	0+35	Empotrar	N	ON/OFF	570	77	72	234,74€
10383181077ASIM	16w	2400Lm	3000K	Asimétrica	0+35	Empotrar	B	DALI	570	77	72	288,48€
10383281077ASIM	16w	2400Lm	3000K	Asimétrica	0+35	Empotrar	G	DALI	570	77	72	288,48€
10383381077ASIM	16w	2400Lm	3000K	Asimétrica	0+35	Empotrar	N	DALI	570	77	72	308,30€
10383102077ASIM	32w	4800Lm	3000K	Asimétrica	0+35	Empotrar	B	ON/OFF	1130	77	72	263,15€
10383202077ASIM	32w	4800Lm	3000K	Asimétrica	0+35	Empotrar	G	ON/OFF	1130	77	72	263,15€
10383302077ASIM	32w	4800Lm	3000K	Asimétrica	0+35	Empotrar	N	ON/OFF	1130	77	72	282,96€
10383182077ASIM	32w	4800Lm	3000K	Asimétrica	0+35	Empotrar	B	DALI	1130	77	72	338,78€
10383282077ASIM	32w	4800Lm	3000K	Asimétrica	0+35	Empotrar	G	DALI	1130	77	72	338,78€
10383382077ASIM	32w	4800Lm	3000K	Asimétrica	0+35	Empotrar	N	DALI	1130	77	72	358,59€
10383104177ASIM	40w	6000Lm	3000K	Asimétrica	0+35	Empotrar	B	ON/OFF	1410	77	72	307,22€
10383204177ASIM	40w	6000Lm	3000K	Asimétrica	0+35	Empotrar	G	ON/OFF	1410	77	72	307,22€
10383304177ASIM	40w	6000Lm	3000K	Asimétrica	0+35	Empotrar	N	ON/OFF	1410	77	72	327,04€
10383184177ASIM	40w	6000Lm	3000K	Asimétrica	0+35	Empotrar	B	DALI	1410	77	72	384,81€
10383284177ASIM	40w	6000Lm	3000K	Asimétrica	0+35	Empotrar	G	DALI	1410	77	72	384,81€
10383384177ASIM	40w	6000Lm	3000K	Asimétrica	0+35	Empotrar	N	DALI	1410	77	72	404,63€
10383103077ASIM	48w	7200Lm	3000K	Asimétrica	0+35	Empotrar	B	ON/OFF	1690	77	72	331,85€
10383203077ASIM	48w	7200Lm	3000K	Asimétrica	0+35	Empotrar	G	ON/OFF	1690	77	72	331,85€
10383303077ASIM	48w	7200Lm	3000K	Asimétrica	0+35	Empotrar	N	ON/OFF	1690	77	72	351,67€
10383183077ASIM	48w	7200Lm	3000K	Asimétrica	0+35	Empotrar	B	DALI	1690	77	72	410,48€
10383283077ASIM	48w	7200Lm	3000K	Asimétrica	0+35	Empotrar	G	DALI	1690	77	72	410,48€
10383383077ASIM	48w	7200Lm	3000K	Asimétrica	0+35	Empotrar	N	DALI	1690	77	72	430,30€
10384101077ASIM	16w	2400Lm	4000K	Asimétrica	0+35	Empotrar	B	ON/OFF	570	77	72	214,93€
10384201077ASIM	16w	2400Lm	4000K	Asimétrica	0+35	Empotrar	G	ON/OFF	570	77	72	214,93€
10384301077ASIM	16w	2400Lm	4000K	Asimétrica	0+35	Empotrar	N	ON/OFF	570	77	72	234,74€
10384181077ASIM	16w	2400Lm	4000K	Asimétrica	0+35	Empotrar	B	DALI	570	77	72	288,48€
10384281077ASIM	16w	2400Lm	4000K	Asimétrica	0+35	Empotrar	G	DALI	570	77	72	288,48€
10384381077ASIM	16w	2400Lm	4000K	Asimétrica	0+35	Empotrar	N	DALI	570	77	72	308,30€
10384102077ASIM	32w	4800Lm	4000K	Asimétrica	0+35	Empotrar	B	ON/OFF	1130	77	72	263,15€
10384202077ASIM	32w	4800Lm	4000K	Asimétrica	0+35	Empotrar	G	ON/OFF	1130	77	72	263,15€
10384302077ASIM	32w	4800Lm	4000K	Asimétrica	0+35	Empotrar	N	ON/OFF	1130	77	72	282,96€
10384182077ASIM	32w	4800Lm	4000K	Asimétrica	0+35	Empotrar	B	DALI	1130	77	72	338,78€
10384282077ASIM	32w	4800Lm	4000K	Asimétrica	0+35	Empotrar	G	DALI	1130	77	72	338,78€
10384382077ASIM	32w	4800Lm	4000K	Asimétrica	0+35	Empotrar	N	DALI	1130	77	72	358,59€
10384104177ASIM	40w	6000Lm	4000K	Asimétrica	0+35	Empotrar	B	ON/OFF	1410	77	72	307,22€
10384204177ASIM	40w	6000Lm	4000K	Asimétrica	0+35	Empotrar	G	ON/OFF	1410	77	72	307,22€
10384304177ASIM	40w	6000Lm	4000K	Asimétrica	0+35	Empotrar	N	ON/OFF	1410	77	72	327,04€
10384184177ASIM	40w	6000Lm	4000K	Asimétrica	0+35	Empotrar	B	DALI	1410	77	72	384,81€
10384284177ASIM	40w	6000Lm	4000K	Asimétrica	0+35	Empotrar	G	DALI	1410	77	72	384,81€
10384384177ASIM	40w	6000Lm	4000K	Asimétrica	0+35	Empotrar	N	DALI	1410	77	72	404,63€
10384103077ASIM	48w	7200Lm	4000K	Asimétrica	0+35	Empotrar	B	ON/OFF	1690	77	72	331,85€
10384203077ASIM	48w	7200Lm	4000K	Asimétrica	0+35	Empotrar	G	ON/OFF	1690	77	72	331,85€
10384303077ASIM	48w	7200Lm	4000K	Asimétrica	0+35	Empotrar	N	ON/OFF	1690	77	72	351,67€
10384183077ASIM	48w	7200Lm	4000K	Asimétrica	0+35	Empotrar	B	DALI	1690	77	72	410,48€
10384283077ASIM	48w	7200Lm	4000K	Asimétrica	0+35	Empotrar	G	DALI	1690	77	72	410,48€
10384383077ASIM	48w	7200Lm	4000K	Asimétrica	0+35	Empotrar	N	DALI	1690	77	72	430,30€

* Accesorios SIMA pag. 107

* Otras temperaturas de color a consultar.

* Otros acabados a consultar.

* Tapas y uniones sin cargo (para formar líneas continuas, indicar en el pedido: PRINCIPIO, INTERMEDIO, FINAL).

* Por defecto se suministrara en formato individual.

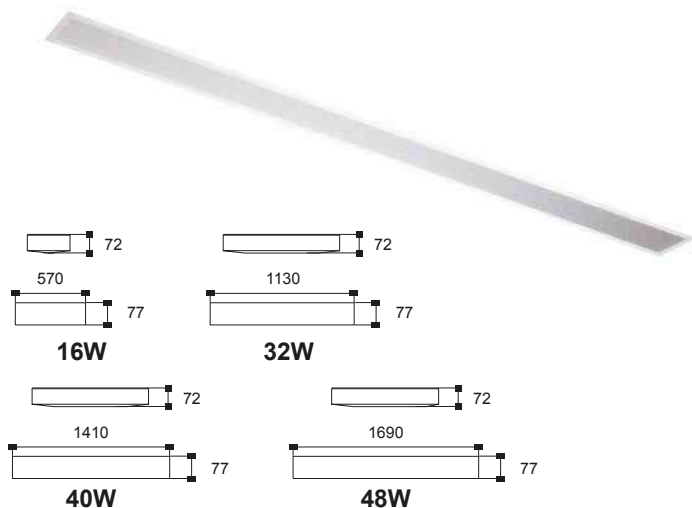

CÓDIGO	W	LM	K	ÓPTICA°		VERSIÓN		ELECTRÓNICA				PVP
									L	W	H	
103831010772ASIM	16w	2400lm	3000K	Doble Asim.	0+35	Empotrar	B	ON/OFF	570	77	72	214,93€
103832010772ASIM	16w	2400lm	3000K	Doble Asim.	0+35	Empotrar	G	ON/OFF	570	77	72	214,93€
103833010772ASIM	16w	2400lm	3000K	Doble Asim.	0+35	Empotrar	N	ON/OFF	570	77	72	234,74€
103831810772ASIM	16w	2400lm	3000K	Doble Asim.	0+35	Empotrar	B	DALI	570	77	72	288,48€
103832810772ASIM	16w	2400lm	3000K	Doble Asim.	0+35	Empotrar	G	DALI	570	77	72	288,48€
103833810772ASIM	16w	2400lm	3000K	Doble Asim.	0+35	Empotrar	N	DALI	570	77	72	308,30€
103831020772ASIM	32w	4800lm	3000K	Doble Asim.	0+35	Empotrar	B	ON/OFF	1130	77	72	263,15€
103832020772ASIM	32w	4800lm	3000K	Doble Asim.	0+35	Empotrar	G	ON/OFF	1130	77	72	263,15€
103833020772ASIM	32w	4800lm	3000K	Doble Asim.	0+35	Empotrar	N	ON/OFF	1130	77	72	282,96€
103831820772ASIM	32w	4800lm	3000K	Doble Asim.	0+35	Empotrar	B	DALI	1130	77	72	338,78€
103832820772ASIM	32w	4800lm	3000K	Doble Asim.	0+35	Empotrar	G	DALI	1130	77	72	338,78€
103833820772ASIM	32w	4800lm	3000K	Doble Asim.	0+35	Empotrar	N	DALI	1130	77	72	358,59€
103831041772ASIM	40w	6000lm	3000K	Doble Asim.	0+35	Empotrar	B	ON/OFF	1410	77	72	307,22€
103832041772ASIM	40w	6000lm	3000K	Doble Asim.	0+35	Empotrar	G	ON/OFF	1410	77	72	307,22€
103833041772ASIM	40w	6000lm	3000K	Doble Asim.	0+35	Empotrar	N	ON/OFF	1410	77	72	327,04€
103831841772ASIM	40w	6000lm	3000K	Doble Asim.	0+35	Empotrar	B	DALI	1410	77	72	384,81€
103832841772ASIM	40w	6000lm	3000K	Doble Asim.	0+35	Empotrar	G	DALI	1410	77	72	384,81€
103833841772ASIM	40w	6000lm	3000K	Doble Asim.	0+35	Empotrar	N	DALI	1410	77	72	404,63€
103831030772ASIM	48w	7200lm	3000K	Doble Asim.	0+35	Empotrar	B	ON/OFF	1690	77	72	331,85€
103832030772ASIM	48w	7200lm	3000K	Doble Asim.	0+35	Empotrar	G	ON/OFF	1690	77	72	331,85€
103833030772ASIM	48w	7200lm	3000K	Doble Asim.	0+35	Empotrar	N	ON/OFF	1690	77	72	351,67€
103831830772ASIM	48w	7200lm	3000K	Doble Asim.	0+35	Empotrar	B	DALI	1690	77	72	410,48€
103832830772ASIM	48w	7200lm	3000K	Doble Asim.	0+35	Empotrar	G	DALI	1690	77	72	410,48€
103833830772ASIM	48w	7200lm	3000K	Doble Asim.	0+35	Empotrar	N	DALI	1690	77	72	430,30€
103841010772ASIM	16w	2400lm	4000K	Doble Asim.	0+35	Empotrar	B	ON/OFF	570	77	72	214,93€
103842010772ASIM	16w	2400lm	4000K	Doble Asim.	0+35	Empotrar	G	ON/OFF	570	77	72	214,93€
103843010772ASIM	16w	2400lm	4000K	Doble Asim.	0+35	Empotrar	N	ON/OFF	570	77	72	234,74€
103841810772ASIM	16w	2400lm	4000K	Doble Asim.	0+35	Empotrar	B	DALI	570	77	72	288,48€
103842810772ASIM	16w	2400lm	4000K	Doble Asim.	0+35	Empotrar	G	DALI	570	77	72	288,48€
103843810772ASIM	16w	2400lm	4000K	Doble Asim.	0+35	Empotrar	N	DALI	570	77	72	308,30€
103841020772ASIM	32w	4800lm	4000K	Doble Asim.	0+35	Empotrar	B	ON/OFF	1130	77	72	263,15€
103842020772ASIM	32w	4800lm	4000K	Doble Asim.	0+35	Empotrar	G	ON/OFF	1130	77	72	263,15€
103843020772ASIM	32w	4800lm	4000K	Doble Asim.	0+35	Empotrar	N	ON/OFF	1130	77	72	282,96€
103841820772ASIM	32w	4800lm	4000K	Doble Asim.	0+35	Empotrar	B	DALI	1130	77	72	338,78€
103842820772ASIM	32w	4800lm	4000K	Doble Asim.	0+35	Empotrar	G	DALI	1130	77	72	338,78€
103843820772ASIM	32w	4800lm	4000K	Doble Asim.	0+35	Empotrar	N	DALI	1130	77	72	358,59€
103841041772ASIM	40w	6000lm	4000K	Doble Asim.	0+35	Empotrar	B	ON/OFF	1410	77	72	307,22€
103842041772ASIM	40w	6000lm	4000K	Doble Asim.	0+35	Empotrar	G	ON/OFF	1410	77	72	307,22€
103843041772ASIM	40w	6000lm	4000K	Doble Asim.	0+35	Empotrar	N	ON/OFF	1410	77	72	327,04€
103841841772ASIM	40w	6000lm	4000K	Doble Asim.	0+35	Empotrar	B	DALI	1410	77	72	384,81€
103842841772ASIM	40w	6000lm	4000K	Doble Asim.	0+35	Empotrar	G	DALI	1410	77	72	384,81€
103843841772ASIM	40w	6000lm	4000K	Doble Asim.	0+35	Empotrar	N	DALI	1410	77	72	404,63€
103841030772ASIM	48w	7200lm	4000K	Doble Asim.	0+35	Empotrar	B	ON/OFF	1690	77	72	331,85€
103842030772ASIM	48w	7200lm	4000K	Doble Asim.	0+35	Empotrar	G	ON/OFF	1690	77	72	331,85€
103843030772ASIM	48w	7200lm	4000K	Doble Asim.	0+35	Empotrar	N	ON/OFF	1690	77	72	351,67€
103841830772ASIM	48w	7200lm	4000K	Doble Asim.	0+35	Empotrar	B	DALI	1690	77	72	410,48€
103842830772ASIM	48w	7200lm	4000K	Doble Asim.	0+35	Empotrar	G	DALI	1690	77	72	410,48€
103843830772ASIM	48w	7200lm	4000K	Doble Asim.	0+35	Empotrar	N	DALI	1690	77	72	430,30€

* Accesorios SIMA pag. 107

* Otras temperaturas de color a consultar.

* Otros acabados a consultar.

* Tapas y uniones sin cargo (para formar líneas continuas, indicar en el pedido: PRINCIPIO, INTERMEDIO, FINAL).

* Por defecto se suministrara en formato individual.

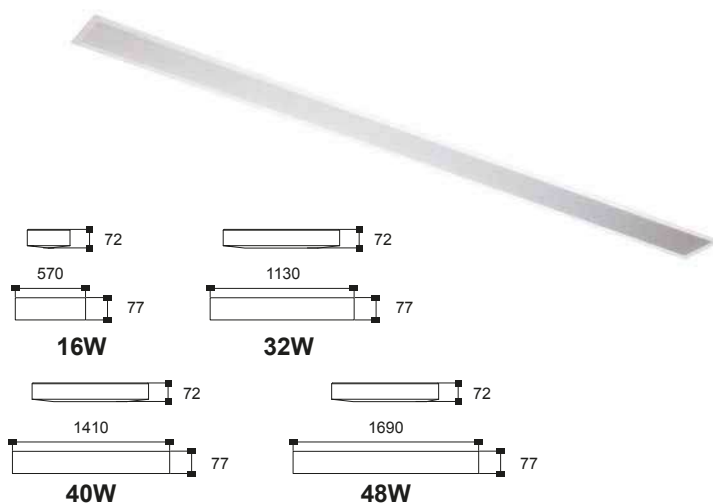

CÓDIGO	W	LM	K	ÓPTICA°		VERSIÓN		ELECTRÓNICA				PVP
									L	W	H	
10383101077EXTN	16w	2400Lm	3000K	Extensiva	0+35	Empotrar	B	ON/OFF	570	77	72	214,93€
10383201077EXTN	16w	2400Lm	3000K	Extensiva	0+35	Empotrar	G	ON/OFF	570	77	72	214,93€
10383301077EXTN	16w	2400Lm	3000K	Extensiva	0+35	Empotrar	N	ON/OFF	570	77	72	234,74€
10383181077EXTN	16w	2400Lm	3000K	Extensiva	0+35	Empotrar	B	DALI	570	77	72	288,48€
10383281077EXTN	16w	2400Lm	3000K	Extensiva	0+35	Empotrar	G	DALI	570	77	72	288,48€
10383381077EXTN	16w	2400Lm	3000K	Extensiva	0+35	Empotrar	N	DALI	570	77	72	308,30€
10383102077EXTN	32w	4800Lm	3000K	Extensiva	0+35	Empotrar	B	ON/OFF	1130	77	72	263,15€
10383202077EXTN	32w	4800Lm	3000K	Extensiva	0+35	Empotrar	G	ON/OFF	1130	77	72	263,15€
10383302077EXTN	32w	4800Lm	3000K	Extensiva	0+35	Empotrar	N	ON/OFF	1130	77	72	282,96€
10383182077EXTN	32w	4800Lm	3000K	Extensiva	0+35	Empotrar	B	DALI	1130	77	72	338,78€
10383282077EXTN	32w	4800Lm	3000K	Extensiva	0+35	Empotrar	G	DALI	1130	77	72	338,78€
10383382077EXTN	32w	4800Lm	3000K	Extensiva	0+35	Empotrar	N	DALI	1130	77	72	358,59€
10383104177EXTN	40w	6000Lm	3000K	Extensiva	0+35	Empotrar	B	ON/OFF	1410	77	72	307,22€
10383204177EXTN	40w	6000Lm	3000K	Extensiva	0+35	Empotrar	G	ON/OFF	1410	77	72	307,22€
10383304177EXTN	40w	6000Lm	3000K	Extensiva	0+35	Empotrar	N	ON/OFF	1410	77	72	327,04€
10383184177EXTN	40w	6000Lm	3000K	Extensiva	0+35	Empotrar	B	DALI	1410	77	72	384,81€
10383284177EXTN	40w	6000Lm	3000K	Extensiva	0+35	Empotrar	G	DALI	1410	77	72	384,81€
10383384177EXTN	40w	6000Lm	3000K	Extensiva	0+35	Empotrar	N	DALI	1410	77	72	404,63€
10383103077EXTN	48w	7200Lm	3000K	Extensiva	0+35	Empotrar	B	ON/OFF	1690	77	72	331,85€
10383203077EXTN	48w	7200Lm	3000K	Extensiva	0+35	Empotrar	G	ON/OFF	1690	77	72	331,85€
10383303077EXTN	48w	7200Lm	3000K	Extensiva	0+35	Empotrar	N	ON/OFF	1690	77	72	351,67€
10383183077EXTN	48w	7200Lm	3000K	Extensiva	0+35	Empotrar	B	DALI	1690	77	72	410,48€
10383283077EXTN	48w	7200Lm	3000K	Extensiva	0+35	Empotrar	G	DALI	1690	77	72	410,48€
10383383077EXTN	48w	7200Lm	3000K	Extensiva	0+35	Empotrar	N	DALI	1690	77	72	430,30€
10384101077EXTN	16w	2400Lm	4000K	Extensiva	0+35	Empotrar	B	ON/OFF	570	77	72	214,93€
10384201077EXTN	16w	2400Lm	4000K	Extensiva	0+35	Empotrar	G	ON/OFF	570	77	72	214,93€
10384301077EXTN	16w	2400Lm	4000K	Extensiva	0+35	Empotrar	N	ON/OFF	570	77	72	234,74€
10384181077EXTN	16w	2400Lm	4000K	Extensiva	0+35	Empotrar	B	DALI	570	77	72	288,48€
10384281077EXTN	16w	2400Lm	4000K	Extensiva	0+35	Empotrar	G	DALI	570	77	72	288,48€
10384381077EXTN	16w	2400Lm	4000K	Extensiva	0+35	Empotrar	N	DALI	570	77	72	308,30€
10384102077EXTN	32w	4800Lm	4000K	Extensiva	0+35	Empotrar	B	ON/OFF	1130	77	72	263,15€
10384202077EXTN	32w	4800Lm	4000K	Extensiva	0+35	Empotrar	G	ON/OFF	1130	77	72	263,15€
10384302077EXTN	32w	4800Lm	4000K	Extensiva	0+35	Empotrar	N	ON/OFF	1130	77	72	282,96€
10384182077EXTN	32w	4800Lm	4000K	Extensiva	0+35	Empotrar	B	DALI	1130	77	72	338,78€
10384282077EXTN	32w	4800Lm	4000K	Extensiva	0+35	Empotrar	G	DALI	1130	77	72	338,78€
10384382077EXTN	32w	4800Lm	4000K	Extensiva	0+35	Empotrar	N	DALI	1130	77	72	358,59€
10384104177EXTN	40w	6000Lm	4000K	Extensiva	0+35	Empotrar	B	ON/OFF	1410	77	72	307,22€
10384204177EXTN	40w	6000Lm	4000K	Extensiva	0+35	Empotrar	G	ON/OFF	1410	77	72	307,22€
10384304177EXTN	40w	6000Lm	4000K	Extensiva	0+35	Empotrar	N	ON/OFF	1410	77	72	327,04€
10384184177EXTN	40w	6000Lm	4000K	Extensiva	0+35	Empotrar	B	DALI	1410	77	72	384,81€
10384284177EXTN	40w	6000Lm	4000K	Extensiva	0+35	Empotrar	G	DALI	1410	77	72	384,81€
10384384177EXTN	40w	6000Lm	4000K	Extensiva	0+35	Empotrar	N	DALI	1410	77	72	404,63€
10384103077EXTN	48w	7200Lm	4000K	Extensiva	0+35	Empotrar	B	ON/OFF	1690	77	72	331,85€
10384203077EXTN	48w	7200Lm	4000K	Extensiva	0+35	Empotrar	G	ON/OFF	1690	77	72	331,85€
10384303077EXTN	48w	7200Lm	4000K	Extensiva	0+35	Empotrar	N	ON/OFF	1690	77	72	351,67€
10384183077EXTN	48w	7200Lm	4000K	Extensiva	0+35	Empotrar	B	DALI	1690	77	72	410,48€
10384283077EXTN	48w	7200Lm	4000K	Extensiva	0+35	Empotrar	G	DALI	1690	77	72	410,48€
10384383077EXTN	48w	7200Lm	4000K	Extensiva	0+35	Empotrar	N	DALI	1690	77	72	430,30€

* Accesorios SIMA pag. 107

* Otras temperaturas de color a consultar.

* Otros acabados a consultar.

* Tapas y uniones sin cargo (para formar líneas continuas, indicar en el pedido: PRINCIPIO, INTERMEDIO, FINAL).

* Por defecto se suministrara en formato individual.

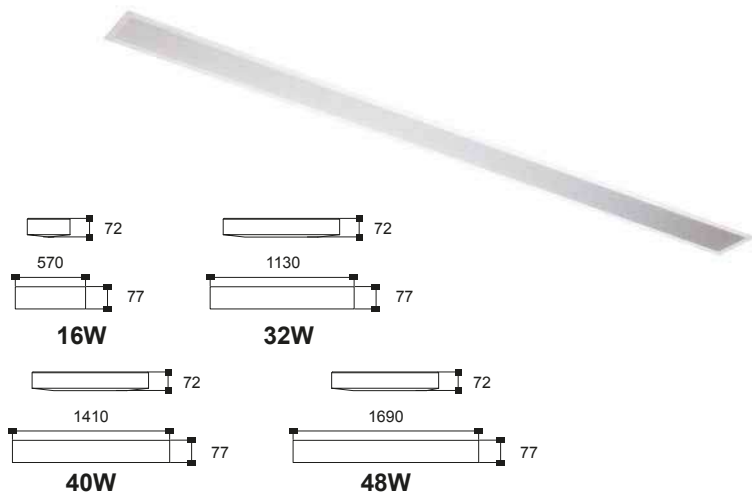

CÓDIGO	W	LM	K	ÓPTICA°		VERSIÓN		ELECTRÓNICA				PVP
									L	W	H	
10383101077INTN	16w	2400Lm	3000K	Intensiva	0+35	Empotrar	B	ON/OFF	570	77	72	214,93€
10383201077INTN	16w	2400Lm	3000K	Intensiva	0+35	Empotrar	G	ON/OFF	570	77	72	214,93€
10383301077INTN	16w	2400Lm	3000K	Intensiva	0+35	Empotrar	N	ON/OFF	570	77	72	234,74€
10383181077INTN	16w	2400Lm	3000K	Intensiva	0+35	Empotrar	B	DALI	570	77	72	288,48€
10383281077INTN	16w	2400Lm	3000K	Intensiva	0+35	Empotrar	G	DALI	570	77	72	288,48€
10383381077INTN	16w	2400Lm	3000K	Intensiva	0+35	Empotrar	N	DALI	570	77	72	308,30€
10383102077INTN	32w	4800Lm	3000K	Intensiva	0+35	Empotrar	B	ON/OFF	1130	77	72	263,15€
10383202077INTN	32w	4800Lm	3000K	Intensiva	0+35	Empotrar	G	ON/OFF	1130	77	72	263,15€
10383302077INTN	32w	4800Lm	3000K	Intensiva	0+35	Empotrar	N	ON/OFF	1130	77	72	282,96€
10383182077INTN	32w	4800Lm	3000K	Intensiva	0+35	Empotrar	B	DALI	1130	77	72	338,78€
10383282077INTN	32w	4800Lm	3000K	Intensiva	0+35	Empotrar	G	DALI	1130	77	72	338,78€
10383382077INTN	32w	4800Lm	3000K	Intensiva	0+35	Empotrar	N	DALI	1130	77	72	358,59€
10383104177INTN	40w	6000Lm	3000K	Intensiva	0+35	Empotrar	B	ON/OFF	1410	77	72	307,22€
10383204177INTN	40w	6000Lm	3000K	Intensiva	0+35	Empotrar	G	ON/OFF	1410	77	72	307,22€
10383304177INTN	40w	6000Lm	3000K	Intensiva	0+35	Empotrar	N	ON/OFF	1410	77	72	327,04€
10383184177INTN	40w	6000Lm	3000K	Intensiva	0+35	Empotrar	B	DALI	1410	77	72	384,81€
10383284177INTN	40w	6000Lm	3000K	Intensiva	0+35	Empotrar	G	DALI	1410	77	72	384,81€
10383384177INTN	40w	6000Lm	3000K	Intensiva	0+35	Empotrar	N	DALI	1410	77	72	404,63€
10383103077INTN	48w	7200Lm	3000K	Intensiva	0+35	Empotrar	B	ON/OFF	1690	77	72	331,85€
10383203077INTN	48w	7200Lm	3000K	Intensiva	0+35	Empotrar	G	ON/OFF	1690	77	72	331,85€
10383303077INTN	48w	7200Lm	3000K	Intensiva	0+35	Empotrar	N	ON/OFF	1690	77	72	351,67€
10383183077INTN	48w	7200Lm	3000K	Intensiva	0+35	Empotrar	B	DALI	1690	77	72	410,48€
10383283077INTN	48w	7200Lm	3000K	Intensiva	0+35	Empotrar	G	DALI	1690	77	72	410,48€
10383383077INTN	48w	7200Lm	3000K	Intensiva	0+35	Empotrar	N	DALI	1690	77	72	430,30€
10384101077INTN	16w	2400Lm	4000K	Intensiva	0+35	Empotrar	B	ON/OFF	570	77	72	214,93€
10384201077INTN	16w	2400Lm	4000K	Intensiva	0+35	Empotrar	G	ON/OFF	570	77	72	214,93€
10384301077INTN	16w	2400Lm	4000K	Intensiva	0+35	Empotrar	N	ON/OFF	570	77	72	234,74€
10384181077INTN	16w	2400Lm	4000K	Intensiva	0+35	Empotrar	B	DALI	570	77	72	288,48€
10384281077INTN	16w	2400Lm	4000K	Intensiva	0+35	Empotrar	G	DALI	570	77	72	288,48€
10384381077INTN	16w	2400Lm	4000K	Intensiva	0+35	Empotrar	N	DALI	570	77	72	308,30€
10384102077INTN	32w	4800Lm	4000K	Intensiva	0+35	Empotrar	B	ON/OFF	1130	77	72	263,15€
10384202077INTN	32w	4800Lm	4000K	Intensiva	0+35	Empotrar	G	ON/OFF	1130	77	72	263,15€
10384302077INTN	32w	4800Lm	4000K	Intensiva	0+35	Empotrar	N	ON/OFF	1130	77	72	282,96€
10384182077INTN	32w	4800Lm	4000K	Intensiva	0+35	Empotrar	B	DALI	1130	77	72	338,78€
10384282077INTN	32w	4800Lm	4000K	Intensiva	0+35	Empotrar	G	DALI	1130	77	72	338,78€
10384382077INTN	32w	4800Lm	4000K	Intensiva	0+35	Empotrar	N	DALI	1130	77	72	358,59€
10384104177INTN	40w	6000Lm	4000K	Intensiva	0+35	Empotrar	B	ON/OFF	1410	77	72	307,22€
10384204177INTN	40w	6000Lm	4000K	Intensiva	0+35	Empotrar	G	ON/OFF	1410	77	72	307,22€
10384304177INTN	40w	6000Lm	4000K	Intensiva	0+35	Empotrar	N	ON/OFF	1410	77	72	327,04€
10384184177INTN	40w	6000Lm	4000K	Intensiva	0+35	Empotrar	B	DALI	1410	77	72	384,81€
10384284177INTN	40w	6000Lm	4000K	Intensiva	0+35	Empotrar	G	DALI	1410	77	72	384,81€
10384384177INTN	40w	6000Lm	4000K	Intensiva	0+35	Empotrar	N	DALI	1410	77	72	404,63€
10384103077INTN	48w	7200Lm	4000K	Intensiva	0+35	Empotrar	B	ON/OFF	1690	77	72	331,85€
10384203077INTN	48w	7200Lm	4000K	Intensiva	0+35	Empotrar	G	ON/OFF	1690	77	72	331,85€
10384303077INTN	48w	7200Lm	4000K	Intensiva	0+35	Empotrar	N	ON/OFF	1690	77	72	351,67€
10384183077INTN	48w	7200Lm	4000K	Intensiva	0+35	Empotrar	B	DALI	1690	77	72	410,48€
10384283077INTN	48w	7200Lm	4000K	Intensiva	0+35	Empotrar	G	DALI	1690	77	72	410,48€
10384383077INTN	48w	7200Lm	4000K	Intensiva	0+35	Empotrar	N	DALI	1690	77	72	430,30€

* Accesorios SIMA pag. 107

* Otras temperaturas de color a consultar.

* Otros acabados a consultar.

* Tapas y uniones sin cargo (para formar líneas continuas, indicar en el pedido: PRINCIPIO, INTERMEDIO, FINAL).

* Por defecto se suministrara en formato individual.

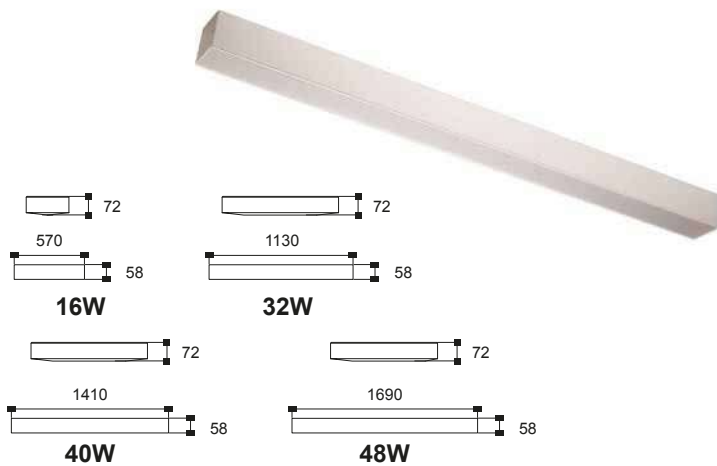

CÓDIGO	W	LM	K	ÓPTICA°		VERSIÓN		ELECTRÓNICA				PVP
									L	W	H	
10383101085D0	16w	1520Lm	3000K	120	0+35	Superficie	B	ON/OFF	570	58	72	162,96€
10383201085D0	16w	1520Lm	3000K	120	0+35	Superficie	G	ON/OFF	570	58	72	167,07€
10383301085D0	16w	1520Lm	3000K	120	0+35	Superficie	N	ON/OFF	570	58	72	182,78€
10383181085D0	16w	1520Lm	3000K	120	0+35	Superficie	B	DALI	570	58	72	197,07€
10383281085D0	16w	3040Lm	3000K	120	0+35	Superficie	G	DALI	570	58	72	201,33€
10383381085D0	16w	3040Lm	3000K	120	0+35	Superficie	N	DALI	570	58	72	216,89€
10383102085D0	32w	3040Lm	3000K	120	0+35	Superficie	B	ON/OFF	1130	58	72	202,26€
10383202085D0	32w	3040Lm	3000K	120	0+35	Superficie	G	ON/OFF	1130	58	72	208,41€
10383302085D0	32w	3040Lm	3000K	120	0+35	Superficie	N	ON/OFF	1130	58	72	222,07€
10383182085D0	32w	3040Lm	3000K	120	0+35	Superficie	B	DALI	1130	58	72	261,04€
10383282085D0	32w	3800Lm	3000K	120	0+35	Superficie	G	DALI	1130	58	72	267,48€
10383382085D0	32w	3800Lm	3000K	120	0+35	Superficie	N	DALI	1130	58	72	280,89€
10383104185D0	40w	3800Lm	3000K	120	0+35	Superficie	B	ON/OFF	1410	58	72	248,89€
10383204185D0	40w	3800Lm	3000K	120	0+35	Superficie	G	ON/OFF	1410	58	72	257,11€
10383304185D0	40w	3800Lm	3000K	120	0+35	Superficie	N	ON/OFF	1410	58	72	268,70€
10383184185D0	40w	3800Lm	3000K	120	0+35	Superficie	B	DALI	1410	58	72	309,70€
10383284185D0	40w	4560Lm	3000K	120	0+35	Superficie	G	DALI	1410	58	72	318,30€
10383384185D0	40w	4560Lm	3000K	120	0+35	Superficie	N	DALI	1410	58	72	329,56€
10383103085D0	48w	4560Lm	3000K	120	0+35	Superficie	B	ON/OFF	1690	58	72	257,44€
10383203085D0	48w	4560Lm	3000K	120	0+35	Superficie	G	ON/OFF	1690	58	72	265,63€
10383303085D0	48w	4560Lm	3000K	120	0+35	Superficie	N	ON/OFF	1690	58	72	277,26€
10383183085D0	48w	4560Lm	3000K	120	0+35	Superficie	B	DALI	1690	58	72	318,63€
10383283085D0	48w	4560Lm	3000K	120	0+35	Superficie	G	DALI	1690	58	72	327,19€
10383383085D0	48w	4560Lm	3000K	120	0+35	Superficie	N	DALI	1690	58	72	338,44€
10384101085D0	16w	1520Lm	4000K	120	0+35	Superficie	B	ON/OFF	570	58	72	162,96€
10384201085D0	16w	1520Lm	4000K	120	0+35	Superficie	G	ON/OFF	570	58	72	167,07€
10384301085D0	16w	1520Lm	4000K	120	0+35	Superficie	N	ON/OFF	570	58	72	182,78€
10384181085D0	16w	1520Lm	4000K	120	0+35	Superficie	B	DALI	570	58	72	197,07€
10384281085D0	16w	3040Lm	4000K	120	0+35	Superficie	G	DALI	570	58	72	201,33€
10384381085D0	16w	3040Lm	4000K	120	0+35	Superficie	N	DALI	570	58	72	216,89€
10384102085D0	32w	3040Lm	4000K	120	0+35	Superficie	B	ON/OFF	1130	58	72	202,26€
10384202085D0	32w	3040Lm	4000K	120	0+35	Superficie	G	ON/OFF	1130	58	72	208,41€
10384302085D0	32w	3040Lm	4000K	120	0+35	Superficie	N	ON/OFF	1130	58	72	222,07€
10384182085D0	32w	3040Lm	4000K	120	0+35	Superficie	B	DALI	1130	58	72	261,04€
10384282085D0	32w	3800Lm	4000K	120	0+35	Superficie	G	DALI	1130	58	72	267,48€
10384382085D0	32w	3800Lm	4000K	120	0+35	Superficie	N	DALI	1130	58	72	280,89€
10384104185D0	40w	3800Lm	4000K	120	0+35	Superficie	B	ON/OFF	1410	58	72	248,89€
10384204185D0	40w	3800Lm	4000K	120	0+35	Superficie	G	ON/OFF	1410	58	72	257,11€
10384304185D0	40w	3800Lm	4000K	120	0+35	Superficie	N	ON/OFF	1410	58	72	268,70€
10384184185D0	40w	3800Lm	4000K	120	0+35	Superficie	B	DALI	1410	58	72	309,70€
10384284185D0	40w	4560Lm	4000K	120	0+35	Superficie	G	DALI	1410	58	72	318,30€
10384384185D0	40w	4560Lm	4000K	120	0+35	Superficie	N	DALI	1410	58	72	329,56€
10384103085D0	48w	4560Lm	4000K	120	0+35	Superficie	B	ON/OFF	1690	58	72	257,44€
10384203085D0	48w	4560Lm	4000K	120	0+35	Superficie	G	ON/OFF	1690	58	72	265,63€
10384303085D0	48w	4560Lm	4000K	120	0+35	Superficie	N	ON/OFF	1690	58	72	277,26€
10384183085D0	48w	4560Lm	4000K	120	0+35	Superficie	B	DALI	1690	58	72	318,63€
10384283085D0	48w	4560Lm	4000K	120	0+35	Superficie	G	DALI	1690	58	72	327,19€
10384383085D0	48w	4560Lm	4000K	120	0+35	Superficie	N	DALI	1690	58	72	338,44€

*Accesorios SIMA pag. 107

*Otras temperaturas de color a consultar.

*Otros acabados a consultar.

*Tapas y uniones sin cargo (para formar líneas continuas, indicar en el pedido: PRINCIPIO, INTERMEDIO, FINAL).

*Por defecto se suministrara en formato individual.

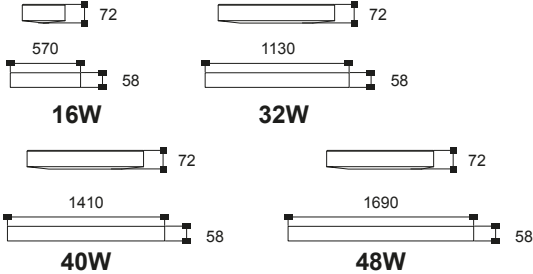

CÓDIGO	W	LM	K	ÓPTICA°	VERSIÓN	ELECTRÓNICA	ELECTRÓNICA			PVP		
							L	W	H			
10383101085DMP	16w	1680Lm	3000K	100	0+35	Superficie	B	ON/OFF	570	58	72	171,19€
10383201085DMP	16w	1680Lm	3000K	100	0+35	Superficie	G	ON/OFF	570	58	72	175,26€
10383301085DMP	16w	1680Lm	3000K	100	0+35	Superficie	N	ON/OFF	570	58	72	191,00€
10383181085DMP	16w	1680Lm	3000K	100	0+35	Superficie	B	DALI	570	58	72	205,63€
10383281085DMP	16w	1680Lm	3000K	100	0+35	Superficie	G	DALI	570	58	72	209,89€
10383381085DMP	16w	1680Lm	3000K	100	0+35	Superficie	N	DALI	570	58	72	225,44€
10383102085DMP	32w	3360Lm	3000K	100	0+35	Superficie	B	ON/OFF	1130	58	72	218,67€
10383202085DMP	32w	3360Lm	3000K	100	0+35	Superficie	G	ON/OFF	1130	58	72	224,81€
10383302085DMP	32w	3360Lm	3000K	100	0+35	Superficie	N	ON/OFF	1130	58	72	238,48€
10383182085DMP	32w	3360Lm	3000K	100	0+35	Superficie	B	DALI	1130	58	72	278,19€
10383282085DMP	32w	3360Lm	3000K	100	0+35	Superficie	G	DALI	1130	58	72	284,59€
10383382085DMP	32w	3360Lm	3000K	100	0+35	Superficie	N	DALI	1130	58	72	298,00€
10383104185DMP	40w	4200Lm	3000K	100	0+35	Superficie	B	ON/OFF	1410	58	72	269,41€
10383204185DMP	40w	4200Lm	3000K	100	0+35	Superficie	G	ON/OFF	1410	58	72	277,63€
10383304185DMP	40w	4200Lm	3000K	100	0+35	Superficie	N	ON/OFF	1410	58	72	289,22€
10383184185DMP	40w	4200Lm	3000K	100	0+35	Superficie	B	DALI	1410	58	72	331,11€
10383284185DMP	40w	4200Lm	3000K	100	0+35	Superficie	G	DALI	1410	58	72	339,67€
10383384185DMP	40w	4200Lm	3000K	100	0+35	Superficie	N	DALI	1410	58	72	350,93€
10383103085DMP	48w	5400Lm	3000K	100	0+35	Superficie	B	ON/OFF	1690	58	72	282,04€
10383203085DMP	48w	5400Lm	3000K	100	0+35	Superficie	G	ON/OFF	1690	58	72	290,26€
10383303085DMP	48w	5400Lm	3000K	100	0+35	Superficie	N	ON/OFF	1690	58	72	301,85€
10383183085DMP	48w	5400Lm	3000K	100	0+35	Superficie	B	DALI	1690	58	72	344,30€
10383283085DMP	48w	5400Lm	3000K	100	0+35	Superficie	G	DALI	1690	58	72	352,85€
10383383085DMP	48w	5400Lm	3000K	100	0+35	Superficie	N	DALI	1690	58	72	364,11€
10384101085DMP	16w	1680Lm	4000K	100	0+35	Superficie	B	ON/OFF	570	58	72	171,19€
10384201085DMP	16w	1680Lm	4000K	100	0+35	Superficie	G	ON/OFF	570	58	72	175,26€
10384301085DMP	16w	1680Lm	4000K	100	0+35	Superficie	N	ON/OFF	570	58	72	191,00€
10384181085DMP	16w	1680Lm	4000K	100	0+35	Superficie	B	DALI	570	58	72	205,63€
10384281085DMP	16w	1680Lm	4000K	100	0+35	Superficie	G	DALI	570	58	72	209,89€
10384381085DMP	16w	1680Lm	4000K	100	0+35	Superficie	N	DALI	570	58	72	225,44€
10384102085DMP	32w	3360Lm	4000K	100	0+35	Superficie	B	ON/OFF	1130	58	72	218,67€
10384202085DMP	32w	3360Lm	4000K	100	0+35	Superficie	G	ON/OFF	1130	58	72	224,81€
10384302085DMP	32w	3360Lm	4000K	100	0+35	Superficie	N	ON/OFF	1130	58	72	238,48€
10384182085DMP	32w	3360Lm	4000K	100	0+35	Superficie	B	DALI	1130	58	72	278,19€
10384282085DMP	32w	3360Lm	4000K	100	0+35	Superficie	G	DALI	1130	58	72	284,59€
10384382085DMP	32w	3360Lm	4000K	100	0+35	Superficie	N	DALI	1130	58	72	298,00€
10384104185DMP	40w	4200Lm	4000K	100	0+35	Superficie	B	ON/OFF	1410	58	72	269,41€
10384204185DMP	40w	4200Lm	4000K	100	0+35	Superficie	G	ON/OFF	1410	58	72	277,63€
10384304185DMP	40w	4200Lm	4000K	100	0+35	Superficie	N	ON/OFF	1410	58	72	289,22€
10384184185DMP	40w	4200Lm	4000K	100	0+35	Superficie	B	DALI	1410	58	72	331,11€
10384284185DMP	40w	4200Lm	4000K	100	0+35	Superficie	G	DALI	1410	58	72	339,67€
10384384185DMP	40w	4200Lm	4000K	100	0+35	Superficie	N	DALI	1410	58	72	350,93€
10384103085DMP	48w	5400Lm	4000K	100	0+35	Superficie	B	ON/OFF	1690	58	72	282,04€
10384203085DMP	48w	5400Lm	4000K	100	0+35	Superficie	G	ON/OFF	1690	58	72	290,26€
10384303085DMP	48w	5400Lm	4000K	100	0+35	Superficie	N	ON/OFF	1690	58	72	301,85€
10384183085DMP	48w	5400Lm	4000K	100	0+35	Superficie	B	DALI	1690	58	72	344,30€
10384283085DMP	48w	5400Lm	4000K	100	0+35	Superficie	G	DALI	1690	58	72	352,85€
10384383085DMP	48w	5400Lm	4000K	100	0+35	Superficie	N	DALI	1690	58	72	364,11€

* Accesorios SIMA pag. 107

* Otras temperaturas de color a consultar.

* Otros acabados a consultar.

* Tapas y uniones sin cargo (para formar líneas continuas, indicar en el pedido: PRINCIPIO, INTERMEDIO, FINAL).

* Por defecto se suministrara en formato individual.

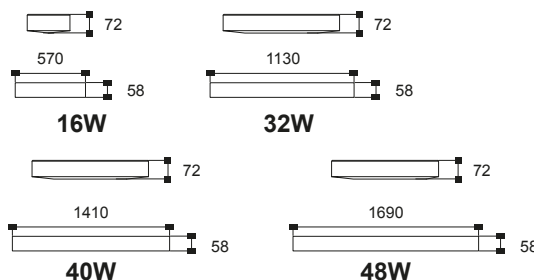

CÓDIGO	W	LM	K	ÓPTICA°		VERSIÓN		ELECTRÓNICA				PVP
									L	W	H	
10383101085COV	16w	1568Lm	3000K	90	0+35	Superficie	B	ON/OFF	570	58	72	208,07€
10383201085COV	16w	1568Lm	3000K	90	0+35	Superficie	G	ON/OFF	570	58	72	212,19€
10383301085COV	16w	1568Lm	3000K	90	0+35	Superficie	N	ON/OFF	570	58	72	227,93€
10383181085COV	16w	1568Lm	3000K	90	0+35	Superficie	B	DALI	570	58	72	244,15€
10383281085COV	16w	1568Lm	3000K	90	0+35	Superficie	G	DALI	570	58	72	248,44€
10383381085COV	16w	1568Lm	3000K	90	0+35	Superficie	N	DALI	570	58	72	263,96€
10383102085COV	32w	3136Lm	3000K	90	0+35	Superficie	B	ON/OFF	1130	58	72	247,37€
10383202085COV	32w	3136Lm	3000K	90	0+35	Superficie	G	ON/OFF	1130	58	72	253,56€
10383302085COV	32w	3136Lm	3000K	90	0+35	Superficie	N	ON/OFF	1130	58	72	267,22€
10383182085COV	32w	3136Lm	3000K	90	0+35	Superficie	B	DALI	1130	58	72	306,63€
10383282085COV	32w	3136Lm	3000K	90	0+35	Superficie	G	DALI	1130	58	72	314,56€
10383382085COV	32w	3136Lm	3000K	90	0+35	Superficie	N	DALI	1130	58	72	319,04€
10383104185COV	40w	3920Lm	3000K	90	0+35	Superficie	B	ON/OFF	1410	58	72	296,07€
10383204185COV	40w	3920Lm	3000K	90	0+35	Superficie	G	ON/OFF	1410	58	72	304,30€
10383304185COV	40w	3920Lm	3000K	90	0+35	Superficie	N	ON/OFF	1410	58	72	315,89€
10383184185COV	40w	3920Lm	3000K	90	0+35	Superficie	B	DALI	1410	58	72	358,96€
10383284185COV	40w	3920Lm	3000K	90	0+35	Superficie	G	DALI	1410	58	72	367,52€
10383384185COV	40w	3920Lm	3000K	90	0+35	Superficie	N	DALI	1410	58	72	378,78€
10383103085COV	48w	4704Lm	3000K	90	0+35	Superficie	B	ON/OFF	1690	58	72	321,00€
10383203085COV	48w	4704Lm	3000K	90	0+35	Superficie	G	ON/OFF	1690	58	72	329,22€
10383303085COV	48w	4704Lm	3000K	90	0+35	Superficie	N	ON/OFF	1690	58	72	340,85€
10383183085COV	48w	4704Lm	3000K	90	0+35	Superficie	B	DALI	1690	58	72	384,96€
10383283085COV	48w	4704Lm	3000K	90	0+35	Superficie	G	DALI	1690	58	72	393,52€
10383383085COV	48w	4704Lm	3000K	90	0+35	Superficie	N	DALI	1690	58	72	404,78€
10384101085COV	16w	1568Lm	4000K	90	0+35	Superficie	B	ON/OFF	570	58	72	208,07€
10384201085COV	16w	1568Lm	4000K	90	0+35	Superficie	G	ON/OFF	570	58	72	212,19€
10384301085COV	16w	1568Lm	4000K	90	0+35	Superficie	N	ON/OFF	570	58	72	227,93€
10384181085COV	16w	1568Lm	4000K	90	0+35	Superficie	B	DALI	570	58	72	244,15€
10384281085COV	16w	1568Lm	4000K	90	0+35	Superficie	G	DALI	570	58	72	248,44€
10384381085COV	16w	1568Lm	4000K	90	0+35	Superficie	N	DALI	570	58	72	263,96€
10384102085COV	32w	3136Lm	4000K	90	0+35	Superficie	B	ON/OFF	1130	58	72	247,37€
10384202085COV	32w	3136Lm	4000K	90	0+35	Superficie	G	ON/OFF	1130	58	72	253,56€
10384302085COV	32w	3136Lm	4000K	90	0+35	Superficie	N	ON/OFF	1130	58	72	267,22€
10384182085COV	32w	3136Lm	4000K	90	0+35	Superficie	B	DALI	1130	58	72	306,63€
10384282085COV	32w	3136Lm	4000K	90	0+35	Superficie	G	DALI	1130	58	72	314,56€
10384382085COV	32w	3136Lm	4000K	90	0+35	Superficie	N	DALI	1130	58	72	319,04€
10384104185COV	40w	3920Lm	4000K	90	0+35	Superficie	B	ON/OFF	1410	58	72	296,07€
10384204185COV	40w	3920Lm	4000K	90	0+35	Superficie	G	ON/OFF	1410	58	72	304,30€
10384304185COV	40w	3920Lm	4000K	90	0+35	Superficie	N	ON/OFF	1410	58	72	315,89€
10384184185COV	40w	3920Lm	4000K	90	0+35	Superficie	B	DALI	1410	58	72	358,96€
10384284185COV	40w	3920Lm	4000K	90	0+35	Superficie	G	DALI	1410	58	72	367,52€
10384384185COV	40w	3920Lm	4000K	90	0+35	Superficie	N	DALI	1410	58	72	378,78€
10384103085COV	48w	4704Lm	4000K	90	0+35	Superficie	B	ON/OFF	1690	58	72	321,00€
10384203085COV	48w	4704Lm	4000K	90	0+35	Superficie	G	ON/OFF	1690	58	72	329,22€
10384303085COV	48w	4704Lm	4000K	90	0+35	Superficie	N	ON/OFF	1690	58	72	340,85€
10384183085COV	48w	4704Lm	4000K	90	0+35	Superficie	B	DALI	1690	58	72	384,96€
10384283085COV	48w	4704Lm	4000K	90	0+35	Superficie	G	DALI	1690	58	72	393,52€
10384383085COV	48w	4704Lm	4000K	90	0+35	Superficie	N	DALI	1690	58	72	404,78€

* Accesorios SIMA pag. 107

* Otras temperaturas de color a consultar.

* Otros acabados a consultar.

* Tapas y uniones sin cargo (para formar líneas continuas, indicar en el pedido: PRINCIPIO, INTERMEDIO, FINAL).

* Por defecto se suministrara en formato individual.

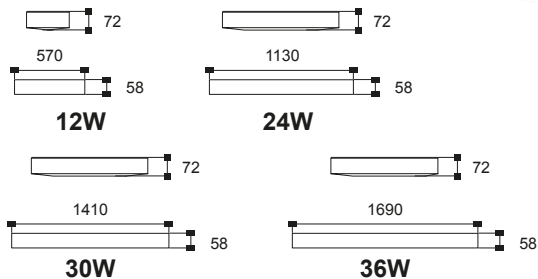
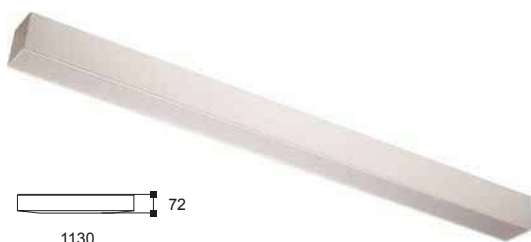

CÓDIGO	W	LM	K	ÓPTICA°	🔌	VERSIÓN	🎨	ELECTRÓNICA	📏			PVP
									L	W	H	
103831010UGR85	12w	900Lm	3000K	90	0+35	Superficie	B	ON/OFF	570	58	72	208,07€
103832010UGR85	12w	900Lm	3000K	90	0+35	Superficie	G	ON/OFF	570	58	72	212,19€
103833010UGR85	12w	900Lm	3000K	90	0+35	Superficie	N	ON/OFF	570	58	72	227,93€
103831810UGR85	12w	900Lm	3000K	90	0+35	Superficie	B	DALI	570	58	72	244,15€
103832810UGR85	12w	900Lm	3000K	90	0+35	Superficie	G	DALI	570	58	72	248,44€
103833810UGR85	12w	900Lm	3000K	90	0+35	Superficie	N	DALI	570	58	72	263,96€
103831020UGR85	24w	1800Lm	3000K	90	0+35	Superficie	B	ON/OFF	1130	58	72	247,37€
103832020UGR85	24w	1800Lm	3000K	90	0+35	Superficie	G	ON/OFF	1130	58	72	253,56€
103833020UGR85	24w	1800Lm	3000K	90	0+35	Superficie	N	ON/OFF	1130	58	72	267,22€
103831820UGR85	24w	1800Lm	3000K	90	0+35	Superficie	B	DALI	1130	58	72	306,63€
103832820UGR85	24w	1800Lm	3000K	90	0+35	Superficie	G	DALI	1130	58	72	314,56€
103833820UGR85	24w	1800Lm	3000K	90	0+35	Superficie	N	DALI	1130	58	72	319,04€
103831041UGR85	30w	2250Lm	3000K	90	0+35	Superficie	B	ON/OFF	1410	58	72	296,07€
103832041UGR85	30w	2250Lm	3000K	90	0+35	Superficie	G	ON/OFF	1410	58	72	304,30€
103833041UGR85	30w	2250Lm	3000K	90	0+35	Superficie	N	ON/OFF	1410	58	72	315,89€
103831841UGR85	30w	2250Lm	3000K	90	0+35	Superficie	B	DALI	1410	58	72	358,96€
103832841UGR85	30w	2250Lm	3000K	90	0+35	Superficie	G	DALI	1410	58	72	367,52€
103833841UGR85	30w	2250Lm	3000K	90	0+35	Superficie	N	DALI	1410	58	72	378,78€
103831030UGR85	36w	2700Lm	3000K	90	0+35	Superficie	B	ON/OFF	1690	58	72	321,00€
103832030UGR85	36w	2700Lm	3000K	90	0+35	Superficie	G	ON/OFF	1690	58	72	329,22€
103833030UGR85	36w	2700Lm	3000K	90	0+35	Superficie	N	ON/OFF	1690	58	72	340,85€
103831830UGR85	36w	2700Lm	3000K	90	0+35	Superficie	B	DALI	1690	58	72	384,96€
103832830UGR85	36w	2700Lm	3000K	90	0+35	Superficie	G	DALI	1690	58	72	393,52€
103833830UGR85	36w	2700Lm	3000K	90	0+35	Superficie	N	DALI	1690	58	72	404,78€
103841010UGR85	12w	900Lm	4000K	90	0+35	Superficie	B	ON/OFF	570	58	72	208,07€
103842010UGR85	12w	900Lm	4000K	90	0+35	Superficie	G	ON/OFF	570	58	72	212,19€
103843010UGR85	12w	900Lm	4000K	90	0+35	Superficie	N	ON/OFF	570	58	72	227,93€
103841810UGR85	12w	900Lm	4000K	90	0+35	Superficie	B	DALI	570	58	72	244,15€
103842810UGR85	12w	900Lm	4000K	90	0+35	Superficie	G	DALI	570	58	72	248,44€
103843810UGR85	12w	900Lm	4000K	90	0+35	Superficie	N	DALI	570	58	72	263,96€
103841020UGR85	24w	1800Lm	4000K	90	0+35	Superficie	B	ON/OFF	1130	58	72	247,37€
103842020UGR85	24w	1800Lm	4000K	90	0+35	Superficie	G	ON/OFF	1130	58	72	253,56€
103843020UGR85	24w	1800Lm	4000K	90	0+35	Superficie	N	ON/OFF	1130	58	72	267,22€
103841820UGR85	24w	1800Lm	4000K	90	0+35	Superficie	B	DALI	1130	58	72	306,63€
103842820UGR85	24w	1800Lm	4000K	90	0+35	Superficie	G	DALI	1130	58	72	314,56€
103843820UGR85	24w	1800Lm	4000K	90	0+35	Superficie	N	DALI	1130	58	72	319,04€
103841041UGR85	30w	2250Lm	4000K	90	0+35	Superficie	B	ON/OFF	1410	58	72	296,07€
103842041UGR85	30w	2250Lm	4000K	90	0+35	Superficie	G	ON/OFF	1410	58	72	304,30€
103843041UGR85	30w	2250Lm	4000K	90	0+35	Superficie	N	ON/OFF	1410	58	72	315,89€
103841841UGR85	30w	2250Lm	4000K	90	0+35	Superficie	B	DALI	1410	58	72	358,96€
103842841UGR85	30w	2250Lm	4000K	90	0+35	Superficie	G	DALI	1410	58	72	367,52€
103843841UGR85	30w	2250Lm	4000K	90	0+35	Superficie	N	DALI	1410	58	72	378,78€
103841030UGR85	36w	2700Lm	4000K	90	0+35	Superficie	B	ON/OFF	1690	58	72	321,00€
103842030UGR85	36w	2700Lm	4000K	90	0+35	Superficie	G	ON/OFF	1690	58	72	329,22€
103843030UGR85	36w	2700Lm	4000K	90	0+35	Superficie	N	ON/OFF	1690	58	72	340,85€
103841830UGR85	36w	2700Lm	4000K	90	0+35	Superficie	B	DALI	1690	58	72	384,96€
103842830UGR85	36w	2700Lm	4000K	90	0+35	Superficie	G	DALI	1690	58	72	393,52€
103843830UGR85	36w	2700Lm	4000K	90	0+35	Superficie	N	DALI	1690	58	72	404,78€

* Accesorios SIMA pag. 107

* Otras temperaturas de color a consultar.

* Otros acabados a consultar.

* Tapas y uniones sin cargo (para formar líneas continuas, indicar en el pedido: PRINCIPIO, INTERMEDIO, FINAL).

* Por defecto se suministrara en formato individual.

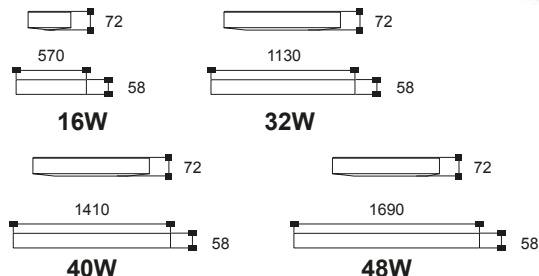

CÓDIGO	W	LM	K	ÓPTICA°		VERSIÓN		ELECTRÓNICA				PVP
									L	W	H	
10383101085ASIM	16w	2400Lm	3000K	Asimétrica	0+35	Superficie	B	ON/OFF	570	58	72	194,44€
10383201085ASIM	16w	2400Lm	3000K	Asimétrica	0+35	Superficie	G	ON/OFF	570	58	72	194,44€
10383301085ASIM	16w	2400Lm	3000K	Asimétrica	0+35	Superficie	N	ON/OFF	570	58	72	214,26€
10383181085ASIM	16w	2400Lm	3000K	Asimétrica	0+35	Superficie	B	DALI	570	58	72	267,07€
10383281085ASIM	16w	2400Lm	3000K	Asimétrica	0+35	Superficie	G	DALI	570	58	72	267,07€
10383381085ASIM	16w	2400Lm	3000K	Asimétrica	0+35	Superficie	N	DALI	570	58	72	286,89€
10383102085ASIM	32w	4800Lm	3000K	Asimétrica	0+35	Superficie	B	ON/OFF	1130	58	72	242,63€
10383202085ASIM	32w	4800Lm	3000K	Asimétrica	0+35	Superficie	G	ON/OFF	1130	58	72	242,63€
10383302085ASIM	32w	4800Lm	3000K	Asimétrica	0+35	Superficie	N	ON/OFF	1130	58	72	262,44€
10383182085ASIM	32w	4800Lm	3000K	Asimétrica	0+35	Superficie	B	DALI	1130	58	72	317,37€
10383282085ASIM	32w	4800Lm	3000K	Asimétrica	0+35	Superficie	G	DALI	1130	58	72	317,37€
10383382085ASIM	32w	4800Lm	3000K	Asimétrica	0+35	Superficie	N	DALI	1130	58	72	337,19€
10383104185ASIM	40w	6000Lm	3000K	Asimétrica	0+35	Superficie	B	ON/OFF	1410	58	72	286,74€
10383204185ASIM	40w	6000Lm	3000K	Asimétrica	0+35	Superficie	G	ON/OFF	1410	58	72	286,74€
10383304185ASIM	40w	6000Lm	3000K	Asimétrica	0+35	Superficie	N	ON/OFF	1410	58	72	306,56€
10383184185ASIM	40w	6000Lm	3000K	Asimétrica	0+35	Superficie	B	DALI	1410	58	72	363,41€
10383284185ASIM	40w	6000Lm	3000K	Asimétrica	0+35	Superficie	G	DALI	1410	58	72	363,41€
10383384185ASIM	40w	6000Lm	3000K	Asimétrica	0+35	Superficie	N	DALI	1410	58	72	383,22€
10383103085ASIM	48w	7200Lm	3000K	Asimétrica	0+35	Superficie	B	ON/OFF	1690	58	72	311,33v
10383203085ASIM	48w	7200Lm	3000K	Asimétrica	0+35	Superficie	G	ON/OFF	1690	58	72	311,33€
10383303085ASIM	48w	7200Lm	3000K	Asimétrica	0+35	Superficie	N	ON/OFF	1690	58	72	331,15€
10383183085ASIM	48w	7200Lm	3000K	Asimétrica	0+35	Superficie	B	DALI	1690	58	72	389,07€
10383283085ASIM	48w	7200Lm	3000K	Asimétrica	0+35	Superficie	G	DALI	1690	58	72	389,07v
10383383085ASIM	48w	7200Lm	3000K	Asimétrica	0+35	Superficie	N	DALI	1690	58	72	408,89€
10384101085ASIM	16w	2400Lm	4000K	Asimétrica	0+35	Superficie	B	ON/OFF	570	58	72	194,44€
10384201085ASIM	16w	2400Lm	4000K	Asimétrica	0+35	Superficie	G	ON/OFF	570	58	72	194,44€
10384301085ASIM	16w	2400Lm	4000K	Asimétrica	0+35	Superficie	N	ON/OFF	570	58	72	214,26€
10384181085ASIM	16w	2400Lm	4000K	Asimétrica	0+35	Superficie	B	DALI	570	58	72	267,07€
10384281085ASIM	16w	2400Lm	4000K	Asimétrica	0+35	Superficie	G	DALI	570	58	72	267,07€
10384381085ASIM	16w	2400Lm	4000K	Asimétrica	0+35	Superficie	N	DALI	570	58	72	286,89€
10384102085ASIM	32w	4800Lm	4000K	Asimétrica	0+35	Superficie	B	ON/OFF	1130	58	72	242,63€
10384202085ASIM	32w	4800Lm	4000K	Asimétrica	0+35	Superficie	G	ON/OFF	1130	58	72	242,63€
10384302085ASIM	32w	4800Lm	4000K	Asimétrica	0+35	Superficie	N	ON/OFF	1130	58	72	262,44€
10384182085ASIM	32w	4800Lm	4000K	Asimétrica	0+35	Superficie	B	DALI	1130	58	72	317,37€
10384282085ASIM	32w	4800Lm	4000K	Asimétrica	0+35	Superficie	G	DALI	1130	58	72	317,37€
10384382085ASIM	32w	4800Lm	4000K	Asimétrica	0+35	Superficie	N	DALI	1130	58	72	337,19€
10384104185ASIM	40w	6000Lm	4000K	Asimétrica	0+35	Superficie	B	ON/OFF	1410	58	72	286,74€
10384204185ASIM	40w	6000Lm	4000K	Asimétrica	0+35	Superficie	G	ON/OFF	1410	58	72	286,74€
10384304185ASIM	40w	6000Lm	4000K	Asimétrica	0+35	Superficie	N	ON/OFF	1410	58	72	306,56€
10384184185ASIM	40w	6000Lm	4000K	Asimétrica	0+35	Superficie	B	DALI	1410	58	72	363,41€
10384284185ASIM	40w	6000Lm	4000K	Asimétrica	0+35	Superficie	G	DALI	1410	58	72	363,41€
10384384185ASIM	40w	6000Lm	4000K	Asimétrica	0+35	Superficie	N	DALI	1410	58	72	383,22€
10384103085ASIM	48w	7200Lm	4000K	Asimétrica	0+35	Superficie	B	ON/OFF	1690	58	72	311,33€
10384203085ASIM	48w	7200Lm	4000K	Asimétrica	0+35	Superficie	G	ON/OFF	1690	58	72	311,33€
10384303085ASIM	48w	7200Lm	4000K	Asimétrica	0+35	Superficie	N	ON/OFF	1690	58	72	331,15€
10384183085ASIM	48w	7200Lm	4000K	Asimétrica	0+35	Superficie	B	DALI	1690	58	72	389,07€
10384283085ASIM	48w	7200Lm	4000K	Asimétrica	0+35	Superficie	G	DALI	1690	58	72	389,07€
10384383085ASIM	48w	7200Lm	4000K	Asimétrica	0+35	Superficie	N	DALI	1690	58	72	408,89€

*Accesorios SIMA pag. 107

*Otras temperaturas de color a consultar.

*Otros acabados a consultar.

*Tapas y uniones sin cargo (para formar líneas continuas, indicar en el pedido: PRINCIPIO, INTERMEDIO, FINAL).

*Por defecto se suministrara en formato individual.

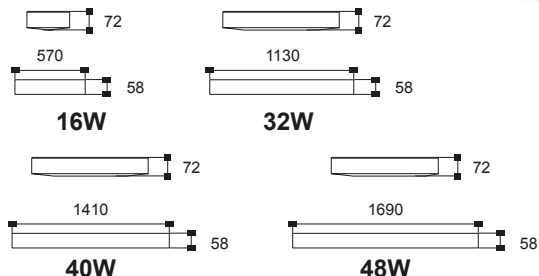

CÓDIGO	W	LM	K	ÓPTICA°		VERSIÓN		ELECTRÓNICA				PVP
									L	W	H	
103831010852ASIM	16w	2400lm	3000K	Doble Asim.	0+35	Superficie	B	ON/OFF	570	58	72	214,93€
103832010852ASIM	16w	2400lm	3000K	Doble Asim.	0+35	Superficie	G	ON/OFF	570	58	72	214,93€
103833010852ASIM	16w	2400lm	3000K	Doble Asim.	0+35	Superficie	N	ON/OFF	570	58	72	234,74€
103831810852ASIM	16w	2400lm	3000K	Doble Asim.	0+35	Superficie	B	DALI	570	58	72	288,48€
103832810852ASIM	16w	2400lm	3000K	Doble Asim.	0+35	Superficie	G	DALI	570	58	72	288,48€
103833810852ASIM	16w	2400lm	3000K	Doble Asim.	0+35	Superficie	N	DALI	570	58	72	308,30€
103831020852ASIM	32w	4800lm	3000K	Doble Asim.	0+35	Superficie	B	ON/OFF	1130	58	72	263,15€
103832020852ASIM	32w	4800lm	3000K	Doble Asim.	0+35	Superficie	G	ON/OFF	1130	58	72	263,15€
103833020852ASIM	32w	4800lm	3000K	Doble Asim.	0+35	Superficie	N	ON/OFF	1130	58	72	282,96€
103831820852ASIM	32w	4800lm	3000K	Doble Asim.	0+35	Superficie	B	DALI	1130	58	72	338,78€
103832820852ASIM	32w	4800lm	3000K	Doble Asim.	0+35	Superficie	G	DALI	1130	58	72	338,78€
103833820852ASIM	32w	4800lm	3000K	Doble Asim.	0+35	Superficie	N	DALI	1130	58	72	358,59€
103831041852ASIM	40w	6000lm	3000K	Doble Asim.	0+35	Superficie	B	ON/OFF	1410	58	72	307,22€
103832041852ASIM	40w	6000lm	3000K	Doble Asim.	0+35	Superficie	G	ON/OFF	1410	58	72	307,22€
103833041852ASIM	40w	6000lm	3000K	Doble Asim.	0+35	Superficie	N	ON/OFF	1410	58	72	327,04€
103831841852ASIM	40w	6000lm	3000K	Doble Asim.	0+35	Superficie	B	DALI	1410	58	72	384,81€
103832841852ASIM	40w	6000lm	3000K	Doble Asim.	0+35	Superficie	G	DALI	1410	58	72	384,81€
103833841852ASIM	40w	6000lm	3000K	Doble Asim.	0+35	Superficie	N	DALI	1410	58	72	404,63€
103831030852ASIM	48w	7200lm	3000K	Doble Asim.	0+35	Superficie	B	ON/OFF	1690	58	72	331,85€
103832030852ASIM	48w	7200lm	3000K	Doble Asim.	0+35	Superficie	G	ON/OFF	1690	58	72	331,85€
103833030852ASIM	48w	7200lm	3000K	Doble Asim.	0+35	Superficie	N	ON/OFF	1690	58	72	351,67€
103831830852ASIM	48w	7200lm	3000K	Doble Asim.	0+35	Superficie	B	DALI	1690	58	72	410,48€
103832830852ASIM	48w	7200lm	3000K	Doble Asim.	0+35	Superficie	G	DALI	1690	58	72	410,48€
103833830852ASIM	48w	7200lm	3000K	Doble Asim.	0+35	Superficie	N	DALI	1690	58	72	430,30€
103841010852ASIM	16w	2400lm	4000K	Doble Asim.	0+35	Superficie	B	ON/OFF	570	58	72	214,93€
103842010852ASIM	16w	2400lm	4000K	Doble Asim.	0+35	Superficie	G	ON/OFF	570	58	72	214,93€
103843010852ASIM	16w	2400lm	4000K	Doble Asim.	0+35	Superficie	N	ON/OFF	570	58	72	234,74€
103841810852ASIM	16w	2400lm	4000K	Doble Asim.	0+35	Superficie	B	DALI	570	58	72	288,48€
103842810852ASIM	16w	2400lm	4000K	Doble Asim.	0+35	Superficie	G	DALI	570	58	72	288,48€
103843810852ASIM	16w	2400lm	4000K	Doble Asim.	0+35	Superficie	N	DALI	570	58	72	308,30€
103841020852ASIM	32w	4800lm	4000K	Doble Asim.	0+35	Superficie	B	ON/OFF	1130	58	72	263,15€
103842020852ASIM	32w	4800lm	4000K	Doble Asim.	0+35	Superficie	G	ON/OFF	1130	58	72	263,15€
103843020852ASIM	32w	4800lm	4000K	Doble Asim.	0+35	Superficie	N	ON/OFF	1130	58	72	282,96€
103841820852ASIM	32w	4800lm	4000K	Doble Asim.	0+35	Superficie	B	DALI	1130	58	72	338,78€
103842820852ASIM	32w	4800lm	4000K	Doble Asim.	0+35	Superficie	G	DALI	1130	58	72	338,78€
103843820852ASIM	32w	4800lm	4000K	Doble Asim.	0+35	Superficie	N	DALI	1130	58	72	358,59€
103841041852ASIM	40w	6000lm	4000K	Doble Asim.	0+35	Superficie	B	ON/OFF	1410	58	72	307,22€
103842041852ASIM	40w	6000lm	4000K	Doble Asim.	0+35	Superficie	G	ON/OFF	1410	58	72	307,22€
103843041852ASIM	40w	6000lm	4000K	Doble Asim.	0+35	Superficie	N	ON/OFF	1410	58	72	327,04€
103841841852ASIM	40w	6000lm	4000K	Doble Asim.	0+35	Superficie	B	DALI	1410	58	72	384,81€
103842841852ASIM	40w	6000lm	4000K	Doble Asim.	0+35	Superficie	G	DALI	1410	58	72	384,81€
103843841852ASIM	40w	6000lm	4000K	Doble Asim.	0+35	Superficie	N	DALI	1410	58	72	404,63€
103841030852ASIM	48w	7200lm	4000K	Doble Asim.	0+35	Superficie	B	ON/OFF	1690	58	72	331,85€
103842030852ASIM	48w	7200lm	4000K	Doble Asim.	0+35	Superficie	G	ON/OFF	1690	58	72	331,85€
103843030852ASIM	48w	7200lm	4000K	Doble Asim.	0+35	Superficie	N	ON/OFF	1690	58	72	351,67€
103841830852ASIM	48w	7200lm	4000K	Doble Asim.	0+35	Superficie	B	DALI	1690	58	72	410,48€
103842830852ASIM	48w	7200lm	4000K	Doble Asim.	0+35	Superficie	G	DALI	1690	58	72	410,48€
103843830852ASIM	48w	7200lm	4000K	Doble Asim.	0+35	Superficie	N	DALI	1690	58	72	430,30€

* Accesorios SIMA pag. 107

* Otras temperaturas de color a consultar.

* Otros acabados a consultar.

* Tapas y uniones sin cargo (para formar líneas continuas, indicar en el pedido: PRINCIPIO, INTERMEDIO, FINAL).

* Por defecto se suministrara en formato individual.

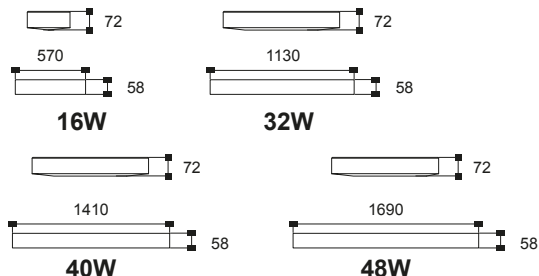

CÓDIGO	W	LM	K	ÓPTICA°		VERSIÓN		ELECTRÓNICA				PVP
									L	W	H	
10383101085EXTN	16w	2400Lm	3000K	Extensiva	0+35	Superficie	B	ON/OFF	570	58	72	194,44€
10383201085EXTN	16w	2400Lm	3000K	Extensiva	0+35	Superficie	G	ON/OFF	570	58	72	194,44€
10383301085EXTN	16w	2400Lm	3000K	Extensiva	0+35	Superficie	N	ON/OFF	570	58	72	214,26€
10383181085EXTN	16w	2400Lm	3000K	Extensiva	0+35	Superficie	B	DALI	570	58	72	267,07€
10383281085EXTN	16w	2400Lm	3000K	Extensiva	0+35	Superficie	G	DALI	570	58	72	267,07€
10383381085EXTN	16w	2400Lm	3000K	Extensiva	0+35	Superficie	N	DALI	570	58	72	286,89€
10383102085EXTN	32w	4800Lm	3000K	Extensiva	0+35	Superficie	B	ON/OFF	1130	58	72	242,63€
10383202085EXTN	32w	4800Lm	3000K	Extensiva	0+35	Superficie	G	ON/OFF	1130	58	72	242,63€
10383302085EXTN	32w	4800Lm	3000K	Extensiva	0+35	Superficie	N	ON/OFF	1130	58	72	262,44€
10383182085EXTN	32w	4800Lm	3000K	Extensiva	0+35	Superficie	B	DALI	1130	58	72	317,37€
10383282085EXTN	32w	4800Lm	3000K	Extensiva	0+35	Superficie	G	DALI	1130	58	72	317,37€
10383382085EXTN	32w	4800Lm	3000K	Extensiva	0+35	Superficie	N	DALI	1130	58	72	337,19€
10383104185EXTN	40w	6000Lm	3000K	Extensiva	0+35	Superficie	B	ON/OFF	1410	58	72	286,74€
10383204185EXTN	40w	6000Lm	3000K	Extensiva	0+35	Superficie	G	ON/OFF	1410	58	72	286,74€
10383304185EXTN	40w	6000Lm	3000K	Extensiva	0+35	Superficie	N	ON/OFF	1410	58	72	306,56€
10383184185EXTN	40w	6000Lm	3000K	Extensiva	0+35	Superficie	B	DALI	1410	58	72	363,41€
10383284185EXTN	40w	6000Lm	3000K	Extensiva	0+35	Superficie	G	DALI	1410	58	72	363,41€
10383384185EXTN	40w	6000Lm	3000K	Extensiva	0+35	Superficie	N	DALI	1410	58	72	383,22€
10383103085EXTN	48w	7200Lm	3000K	Extensiva	0+35	Superficie	B	ON/OFF	1690	58	72	311,33€
10383203085EXTN	48w	7200Lm	3000K	Extensiva	0+35	Superficie	G	ON/OFF	1690	58	72	311,33€
10383303085EXTN	48w	7200Lm	3000K	Extensiva	0+35	Superficie	N	ON/OFF	1690	58	72	331,15€
10383183085EXTN	48w	7200Lm	3000K	Extensiva	0+35	Superficie	B	DALI	1690	58	72	389,07€
10383283085EXTN	48w	7200Lm	3000K	Extensiva	0+35	Superficie	G	DALI	1690	58	72	389,07€
10383383085EXTN	48w	7200Lm	3000K	Extensiva	0+35	Superficie	N	DALI	1690	58	72	408,89€
10384101085EXTN	16w	2400Lm	4000K	Extensiva	0+35	Superficie	B	ON/OFF	570	58	72	194,44€
10384201085EXTN	16w	2400Lm	4000K	Extensiva	0+35	Superficie	G	ON/OFF	570	58	72	194,44€
10384301085EXTN	16w	2400Lm	4000K	Extensiva	0+35	Superficie	N	ON/OFF	570	58	72	214,26€
10384181085EXTN	16w	2400Lm	4000K	Extensiva	0+35	Superficie	B	DALI	570	58	72	267,07€
10384281085EXTN	16w	2400Lm	4000K	Extensiva	0+35	Superficie	G	DALI	570	58	72	267,07€
10384381085EXTN	16w	2400Lm	4000K	Extensiva	0+35	Superficie	N	DALI	570	58	72	286,89€
10384102085EXTN	32w	4800Lm	4000K	Extensiva	0+35	Superficie	B	ON/OFF	1130	58	72	242,63€
10384202085EXTN	32w	4800Lm	4000K	Extensiva	0+35	Superficie	G	ON/OFF	1130	58	72	242,63€
10384302085EXTN	32w	4800Lm	4000K	Extensiva	0+35	Superficie	N	ON/OFF	1130	58	72	262,44€
10384182085EXTN	32w	4800Lm	4000K	Extensiva	0+35	Superficie	B	DALI	1130	58	72	317,37€
10384282085EXTN	32w	4800Lm	4000K	Extensiva	0+35	Superficie	G	DALI	1130	58	72	317,37€
10384382085EXTN	32w	4800Lm	4000K	Extensiva	0+35	Superficie	N	DALI	1130	58	72	337,19€
10384104185EXTN	40w	6000Lm	4000K	Extensiva	0+35	Superficie	B	ON/OFF	1410	58	72	286,74€
10384204185EXTN	40w	6000Lm	4000K	Extensiva	0+35	Superficie	G	ON/OFF	1410	58	72	286,74€
10384304185EXTN	40w	6000Lm	4000K	Extensiva	0+35	Superficie	N	ON/OFF	1410	58	72	306,56€
10384184185EXTN	40w	6000Lm	4000K	Extensiva	0+35	Superficie	B	DALI	1410	58	72	363,41€
10384284185EXTN	40w	6000Lm	4000K	Extensiva	0+35	Superficie	G	DALI	1410	58	72	363,41€
10384384185EXTN	40w	6000Lm	4000K	Extensiva	0+35	Superficie	N	DALI	1410	58	72	383,22€
10384103085EXTN	48w	7200Lm	4000K	Extensiva	0+35	Superficie	B	ON/OFF	1690	58	72	311,33€
10384203085EXTN	48w	7200Lm	4000K	Extensiva	0+35	Superficie	G	ON/OFF	1690	58	72	311,33€
10384303085EXTN	48w	7200Lm	4000K	Extensiva	0+35	Superficie	N	ON/OFF	1690	58	72	331,15€
10384183085EXTN	48w	7200Lm	4000K	Extensiva	0+35	Superficie	B	DALI	1690	58	72	389,07€
10384283085EXTN	48w	7200Lm	4000K	Extensiva	0+35	Superficie	G	DALI	1690	58	72	389,07€
10384383085EXTN	48w	7200Lm	4000K	Extensiva	0+35	Superficie	N	DALI	1690	58	72	408,89€

* Accesorios SIMA pag. 107

* Otras temperaturas de color a consultar.

* Otros acabados a consultar.

* Tapas y uniones sin cargo (para formar líneas continuas, indicar en el pedido: PRINCIPIO, INTERMEDIO, FINAL).

* Por defecto se suministrara en formato individual.

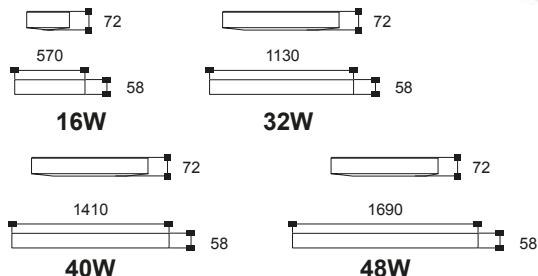
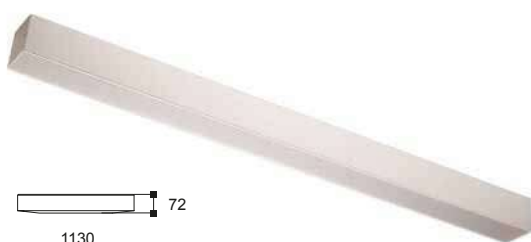

CÓDIGO	W	LM	K	ÓPTICA°		VERSIÓN		ELECTRÓNICA				PVP
									L	W	H	
10383101085INTN	16w	2400Lm	3000K	Intensiva	0+35	Superficie	B	ON/OFF	570	58	72	194,44€
10383201085INTN	16w	2400Lm	3000K	Intensiva	0+35	Superficie	G	ON/OFF	570	58	72	194,44€
10383301085INTN	16w	2400Lm	3000K	Intensiva	0+35	Superficie	N	ON/OFF	570	58	72	214,26€
10383181085INTN	16w	2400Lm	3000K	Intensiva	0+35	Superficie	B	DALI	570	58	72	267,07€
10383281085INTN	16w	2400Lm	3000K	Intensiva	0+35	Superficie	G	DALI	570	58	72	267,07€
10383381085INTN	16w	2400Lm	3000K	Intensiva	0+35	Superficie	N	DALI	570	58	72	286,89€
10383102085INTN	32w	4800Lm	3000K	Intensiva	0+35	Superficie	B	ON/OFF	1130	58	72	242,63€
10383202085INTN	32w	4800Lm	3000K	Intensiva	0+35	Superficie	G	ON/OFF	1130	58	72	242,63€
10383302085INTN	32w	4800Lm	3000K	Intensiva	0+35	Superficie	N	ON/OFF	1130	58	72	262,44€
10383182085INTN	32w	4800Lm	3000K	Intensiva	0+35	Superficie	B	DALI	1130	58	72	317,37€
10383282085INTN	32w	4800Lm	3000K	Intensiva	0+35	Superficie	G	DALI	1130	58	72	317,37€
10383382085INTN	32w	4800Lm	3000K	Intensiva	0+35	Superficie	N	DALI	1130	58	72	337,19€
10383104185INTN	40w	6000Lm	3000K	Intensiva	0+35	Superficie	B	ON/OFF	1410	58	72	286,74€
10383204185INTN	40w	6000Lm	3000K	Intensiva	0+35	Superficie	G	ON/OFF	1410	58	72	286,74€
10383304185INTN	40w	6000Lm	3000K	Intensiva	0+35	Superficie	N	ON/OFF	1410	58	72	306,56€
10383184185INTN	40w	6000Lm	3000K	Intensiva	0+35	Superficie	B	DALI	1410	58	72	363,41€
10383284185INTN	40w	6000Lm	3000K	Intensiva	0+35	Superficie	G	DALI	1410	58	72	363,41€
10383384185INTN	40w	6000Lm	3000K	Intensiva	0+35	Superficie	N	DALI	1410	58	72	383,22€
10383103085INTN	48w	7200Lm	3000K	Intensiva	0+35	Superficie	B	ON/OFF	1690	58	72	311,33€
10383203085INTN	48w	7200Lm	3000K	Intensiva	0+35	Superficie	G	ON/OFF	1690	58	72	311,33€
10383303085INTN	48w	7200Lm	3000K	Intensiva	0+35	Superficie	N	ON/OFF	1690	58	72	331,15€
10383183085INTN	48w	7200Lm	3000K	Intensiva	0+35	Superficie	B	DALI	1690	58	72	389,07€
10383283085INTN	48w	7200Lm	3000K	Intensiva	0+35	Superficie	G	DALI	1690	58	72	389,07€
10383383085INTN	48w	7200Lm	3000K	Intensiva	0+35	Superficie	N	DALI	1690	58	72	408,89€
10384101085INTN	16w	2400Lm	4000K	Intensiva	0+35	Superficie	B	ON/OFF	570	58	72	194,44€
10384201085INTN	16w	2400Lm	4000K	Intensiva	0+35	Superficie	G	ON/OFF	570	58	72	194,44€
10384301085INTN	16w	2400Lm	4000K	Intensiva	0+35	Superficie	N	ON/OFF	570	58	72	214,26€
10384181085INTN	16w	2400Lm	4000K	Intensiva	0+35	Superficie	B	DALI	570	58	72	267,07€
10384281085INTN	16w	2400Lm	4000K	Intensiva	0+35	Superficie	G	DALI	570	58	72	267,07€
10384381085INTN	16w	2400Lm	4000K	Intensiva	0+35	Superficie	N	DALI	570	58	72	286,89€
10384102085INTN	32w	4800Lm	4000K	Intensiva	0+35	Superficie	B	ON/OFF	1130	58	72	242,63€
10384202085INTN	32w	4800Lm	4000K	Intensiva	0+35	Superficie	G	ON/OFF	1130	58	72	242,63€
10384302085INTN	32w	4800Lm	4000K	Intensiva	0+35	Superficie	N	ON/OFF	1130	58	72	262,44€
10384182085INTN	32w	4800Lm	4000K	Intensiva	0+35	Superficie	B	DALI	1130	58	72	317,37€
10384282085INTN	32w	4800Lm	4000K	Intensiva	0+35	Superficie	G	DALI	1130	58	72	317,37€
10384382085INTN	32w	4800Lm	4000K	Intensiva	0+35	Superficie	N	DALI	1130	58	72	337,19€
10384104185INTN	40w	6000Lm	4000K	Intensiva	0+35	Superficie	B	ON/OFF	1410	58	72	286,74€
10384204185INTN	40w	6000Lm	4000K	Intensiva	0+35	Superficie	G	ON/OFF	1410	58	72	286,74€
10384304185INTN	40w	6000Lm	4000K	Intensiva	0+35	Superficie	N	ON/OFF	1410	58	72	306,56€
10384184185INTN	40w	6000Lm	4000K	Intensiva	0+35	Superficie	B	DALI	1410	58	72	363,41€
10384284185INTN	40w	6000Lm	4000K	Intensiva	0+35	Superficie	G	DALI	1410	58	72	363,41€
10384384185INTN	40w	6000Lm	4000K	Intensiva	0+35	Superficie	N	DALI	1410	58	72	383,22€
10384103085INTN	48w	7200Lm	4000K	Intensiva	0+35	Superficie	B	ON/OFF	1690	58	72	311,33€
10384203085INTN	48w	7200Lm	4000K	Intensiva	0+35	Superficie	G	ON/OFF	1690	58	72	311,33€
10384303085INTN	48w	7200Lm	4000K	Intensiva	0+35	Superficie	N	ON/OFF	1690	58	72	331,15€
10384183085INTN	48w	7200Lm	4000K	Intensiva	0+35	Superficie	B	DALI	1690	58	72	389,07€
10384283085INTN	48w	7200Lm	4000K	Intensiva	0+35	Superficie	G	DALI	1690	58	72	389,07€
10384383085INTN	48w	7200Lm	4000K	Intensiva	0+35	Superficie	N	DALI	1690	58	72	408,89€

* Accesorios SIMA pag. 107

* Otras temperaturas de color a consultar.

* Otros acabados a consultar.

* Tapas y uniones sin cargo (para formar líneas continuas, indicar en el pedido: PRINCIPIO, INTERMEDIO, FINAL).

* Por defecto se suministrara en formato individual.

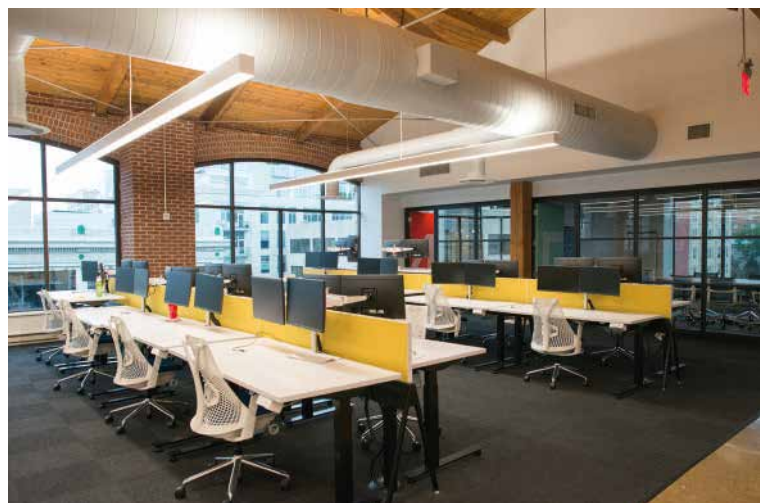
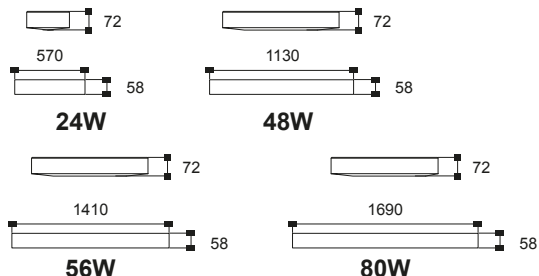

CÓDIGO	W	LM	K	ÓPTICA°	VERSIÓN	ELECTRÓNICA	PVP				
							L	W	H		
10383101077UD	24w	1500/800Lm	3000K	120/100	0+35	Suspensión B	ON/OFF	570	58	72	451,22€
10383201077UD	24w	1500/800Lm	3000K	120/100	0+35	Suspensión G	ON/OFF	570	58	72	451,22€
10383301077UD	24w	1500/800Lm	3000K	120/100	0+35	Suspensión N	ON/OFF	570	58	72	487,52€
10383101077UDC	24w	1500/800Lm	3000K	120/100	0+35	Suspensión B	DALI	570	58	72	516,52€
10383201077UDC	24w	1500/800Lm	3000K	120/100	0+35	Suspensión G	DALI	570	58	72	516,52€
10383301077UDC	24w	1500/800Lm	3000K	120/100	0+35	Suspensión N	DALI	570	58	72	523,63€
10383102077UD	48w	3000/1600Lm	3000K	120/100	0+35	Suspensión B	ON/OFF	1130	58	72	544,13€
10383202077UD	48w	3000/1600Lm	3000K	120/100	0+35	Suspensión G	ON/OFF	1130	58	72	544,13€
10383302077UD	48w	3000/1600Lm	3000K	120/100	0+35	Suspensión N	ON/OFF	1130	58	72	597,16€
10383102077UDC	48w	3000/1600Lm	3000K	120/100	0+35	Suspensión B	DALI	1130	58	72	609,44€
10383202077UDC	48w	3000/1600Lm	3000K	120/100	0+35	Suspensión G	DALI	1130	58	72	609,44€
10383302077UDC	48w	3000/1600Lm	3000K	120/100	0+35	Suspensión N	DALI	1130	58	72	617,86€
10383104177UD	56w	3750/1600Lm	3000K	120/100	0+35	Suspensión B	ON/OFF	1410	58	72	637,04€
10383204177UD	56w	3750/1600Lm	3000K	120/100	0+35	Suspensión G	ON/OFF	1410	58	72	637,04€
10383304177UD	56w	3750/1600Lm	3000K	120/100	0+35	Suspensión N	ON/OFF	1410	58	72	697,50€
10383104177UDC	56w	3750/1600Lm	3000K	120/100	0+35	Suspensión B	DALI	1410	58	72	702,35€
10383204177UDC	56w	3750/1600Lm	3000K	120/100	0+35	Suspensión G	DALI	1410	58	72	702,35€
10383304177UDC	56w	3750/1600Lm	3000K	120/100	0+35	Suspensión N	DALI	1410	58	72	723,65€
10383103077UD	80w	4500/2400Lm	3000K	120/100	0+35	Suspensión B	ON/OFF	1690	58	72	663,59€
10383203077UD	80w	4500/2400Lm	3000K	120/100	0+35	Suspensión G	ON/OFF	1690	58	72	663,59€
10383303077UD	80w	4500/2400Lm	3000K	120/100	0+35	Suspensión N	ON/OFF	1690	58	72	745,29€
10383103077UDC	80w	4500/2400Lm	3000K	120/100	0+35	Suspensión B	DALI	1690	58	72	728,89€
10383203077UDC	80w	4500/2400Lm	3000K	120/100	0+35	Suspensión G	DALI	1690	58	72	728,89€
10383303077UDC	80w	4500/2400Lm	3000K	120/100	0+35	Suspensión N	DALI	1690	58	72	742,23€
10384101077UD	24w	1500/800Lm	4000K	120/100	0+35	Suspensión B	ON/OFF	570	58	72	451,22€
10384201077UD	24w	1500/800Lm	4000K	120/100	0+35	Suspensión G	ON/OFF	570	58	72	451,22€
10384301077UD	24w	1500/800Lm	4000K	120/100	0+35	Suspensión N	ON/OFF	570	58	72	487,52€
10384101077UDC	24w	1500/800Lm	4000K	120/100	0+35	Suspensión B	DALI	570	58	72	516,52€
10384201077UDC	24w	1500/800Lm	4000K	120/100	0+35	Suspensión G	DALI	570	58	72	516,52€
10384301077UDC	24w	1500/800Lm	4000K	120/100	0+35	Suspensión N	DALI	570	58	72	523,63€
10384102077UD	48w	3000/1600Lm	4000K	120/100	0+35	Suspensión B	ON/OFF	1130	58	72	544,13€
10384202077UD	48w	3000/1600Lm	4000K	120/100	0+35	Suspensión G	ON/OFF	1130	58	72	544,13€
10384302077UD	48w	3000/1600Lm	4000K	120/100	0+35	Suspensión N	ON/OFF	1130	58	72	597,16€
10384102077UDC	48w	3000/1600Lm	4000K	120/100	0+35	Suspensión B	DALI	1130	58	72	609,44€
10384202077UDC	48w	3000/1600Lm	4000K	120/100	0+35	Suspensión G	DALI	1130	58	72	609,44€
10384302077UDC	48w	3000/1600Lm	4000K	120/100	0+35	Suspensión N	DALI	1130	58	72	617,86€
10384104177UD	56w	3750/1600Lm	4000K	120/100	0+35	Suspensión B	ON/OFF	1410	58	72	637,04€
10384204177UD	56w	3750/1600Lm	4000K	120/100	0+35	Suspensión G	ON/OFF	1410	58	72	637,04€
10384304177UD	56w	3750/1600Lm	4000K	120/100	0+35	Suspensión N	ON/OFF	1410	58	72	697,50€
10384104177UDC	56w	3750/1600Lm	4000K	120/100	0+35	Suspensión B	DALI	1410	58	72	702,35€
10384204177UDC	56w	3750/1600Lm	4000K	120/100	0+35	Suspensión G	DALI	1410	58	72	702,35€
10384304177UDC	56w	3750/1600Lm	4000K	120/100	0+35	Suspensión N	DALI	1410	58	72	723,65€
10384103077UD	80w	4500/2400Lm	4000K	120/100	0+35	Suspensión B	ON/OFF	1690	58	72	663,59€
10384203077UD	80w	4500/2400Lm	4000K	120/100	0+35	Suspensión G	ON/OFF	1690	58	72	663,59€
10384303077UD	80w	4500/2400Lm	4000K	120/100	0+35	Suspensión N	ON/OFF	1690	58	72	745,29€
10384103077UDC	80w	4500/2400Lm	4000K	120/100	0+35	Suspensión B	DALI	1690	58	72	728,89€
10384203077UDC	80w	4500/2400Lm	4000K	120/100	0+35	Suspensión G	DALI	1690	58	72	728,89€
10384303077UDC	80w	4500/2400Lm	4000K	120/100	0+35	Suspensión N	DALI	1690	58	72	742,23€

* Accesorios SIMA pag. 107
 * Otras temperaturas de color a consultar.
 * Otros acabados a consultar.
 * Tapas y uniones sin cargo (para formar líneas continuas, indicar en el pedido: PRINCIPIO, INTERMEDIO, FINAL).
 * Por defecto se suministrara en formato individual.

ACCESORIOS **SIMA** EMPOTRAR

CÓDIGO	DESCRIPCIÓN	PVP
1038COD09058	ÁNGULO 90° SIMA EMPOTRAR	82,22€
1038315MM58	PRECABLEADO 3X1,5MM2 SIMA EMPOTRAR	39,63€
1038515MM58	PRECABLEADO 5X1,5MM2 SIMA EMPOTRAR	74,30€
1038KE1H	KIT EMERGENCIA 1HORA	222,93€

ACCESORIOS **SIMA** SUPERFICIE

CÓDIGO	DESCRIPCIÓN	PVP
1038KS1M58	KIT SUSPENSIÓN SIMA 1M	44,59€
1038COD09077	ÁNGULO 90° SIMA SUP	82,22€
1038315MM77	PRECABLEADO 3X1,5MM2 SIMA SUP	39,63€
1038515MM77	PRECABLEADO 5X1,5MM2 SIMA SUP	74,30€
1038KE1H	KIT EMERGENCIA 1HORA	222,93€
1038KBM	KIT BRAZO MURAL	59,44€
1038TRIM	SISTEMA TRIMLESS SIMA	49,56€



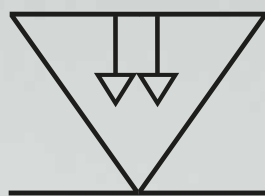

LYOPRO
LEVEL

LUMINARIAS DE EMPOTRAR-SUPERFICIE
RECESSED-SURFACE LUMINAIRES
LUMINAIRES DE ENCASTRÉ-SURFACE

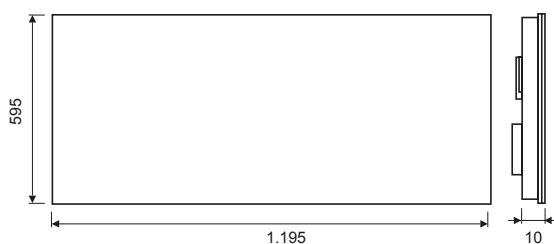
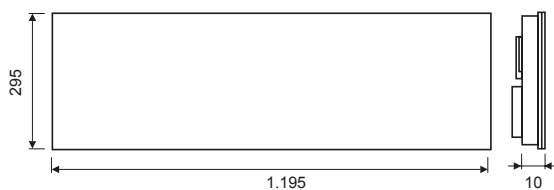
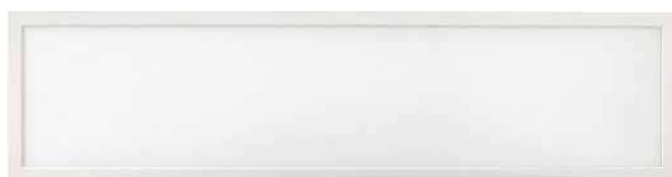
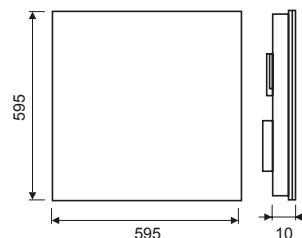
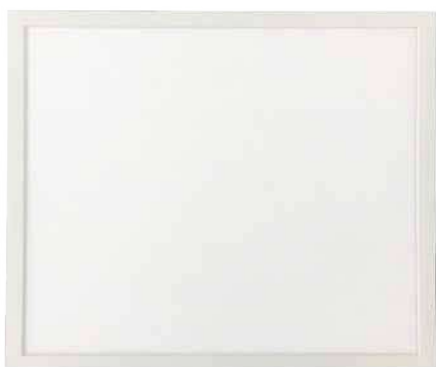

CÓDIGO	W	LM	K	ÓPTICA°	Ra/CRI			L W H			ELECTRÓNICA	PVP
								L	W	H		
60703	40w	4800Lm	4000K	90	>80	-20+40		595	595	10	1-10V	114,95€
60721	40w	4800Lm	4000K	90	>80	-20+40		595	595	10	DALI	171,90€
60704	40w	4800Lm	4000K	90	>80	-20+40		1.195	295	10	1-10V	129,95€
60722	40w	4800Lm	4000K	90	>80	-20+40		1.195	295	10	DALI	182,90€
60705	50w	6000Lm	4000K	90	>80	-20+40		1.195	595	10	1-10V	214,95€
60723	50w	6000Lm	4000K	90	>80	-20+40		1.195	595	10	DALI	300,95€

KIT SUSPENSIÓN

CÓDIGO	METROS	PVP
83128	1	10,95€
88022	1,25	14,95€
88023	1,5	15,45€
88024	2	15,95€
88025	3	16,45€
88026	5	16,95€

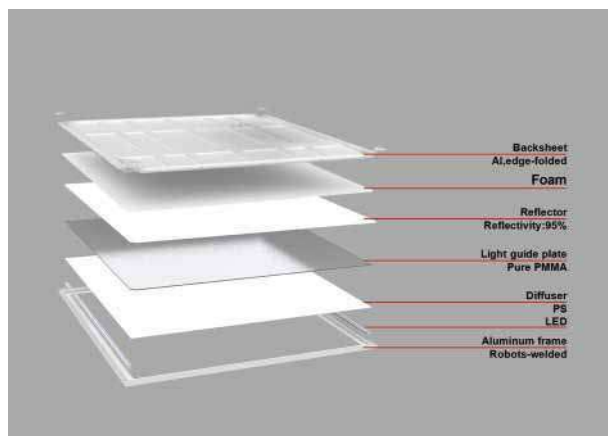

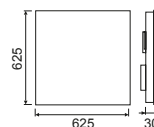

CÓDIGO	W	LM	K	ÓPTICA°		VERSIÓN		ELECTRÓNICA				PVP
									L	W	H	
60710	40w	4000Lm	4000K	90	-20+50	Superficie	B <input type="checkbox"/>	ON/OFF	625	625	30	119,95€
60710A	40w	4000Lm	4000K	90	-20+50	Superficie	B <input type="checkbox"/>	PUSH	625	625	30	139,95€
60710B	40w	4000Lm	4000K	90	-20+50	Superficie	B <input type="checkbox"/>	1-10V	625	625	30	150,50€
60710C	40w	4000Lm	4000K	90	-20+50	Superficie	B <input type="checkbox"/>	DALI	625	625	30	150,50€

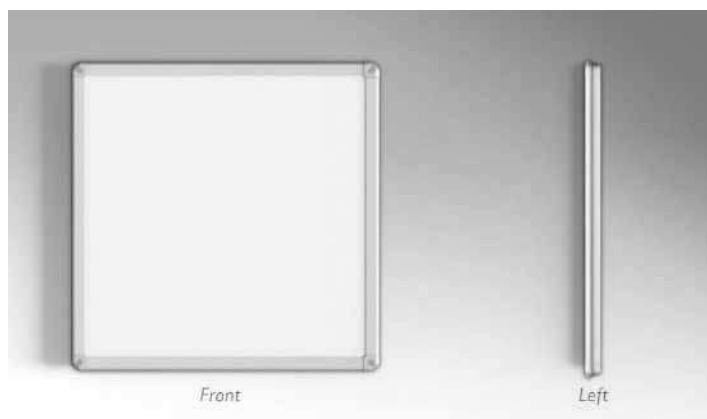

KIT SUSPENSIÓN

CÓDIGO	METROS	PVP
83128	1	10,95€
88022	1,25	14,95€
88023	1,5	15,45€
88024	2	15,95€
88025	3	16,45€
88026	5	16,95€

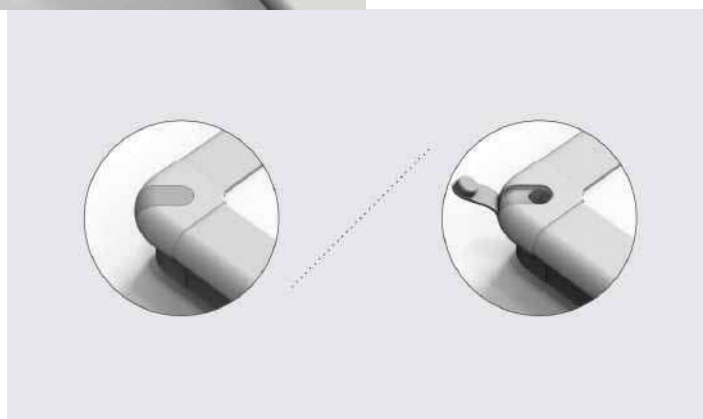
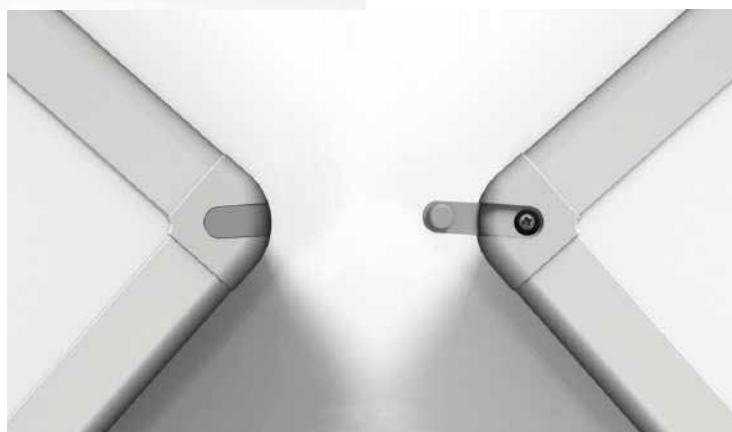

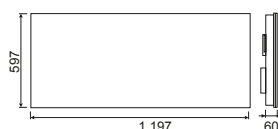
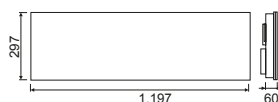
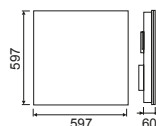

CÓDIGO	W	LM	K	ÓPTICA°		VERSIÓN		ELECTRÓNICA					PVP
									L	W	H		
10383101004C	35w	3300Lm	3000K	90	0+35	Empotrar	<input type="checkbox"/>	ON/OFF	597	597	60	575*575	239,44€
10383171004C	35w	3300Lm	3000K	90	0+35	Empotrar	<input type="checkbox"/>	1-10V	597	597	60	575*575	328,63€
10383181004C	35w	3300Lm	3000K	90	0+35	Empotrar	<input type="checkbox"/>	DALI	597	597	60	575*575	313,78€
10384101004C	35w	3300Lm	4000K	90	0+35	Empotrar	<input type="checkbox"/>	ON/OFF	597	597	60	575*575	239,44€
10384171004C	35w	3300Lm	4000K	90	0+35	Empotrar	<input type="checkbox"/>	1-10V	597	597	60	575*575	328,63€
10384181004C	35w	3300Lm	4000K	90	0+35	Empotrar	<input type="checkbox"/>	DALI	597	597	60	575*575	313,78€
10385101004C	35w	3300Lm	5000K	90	0+35	Empotrar	<input type="checkbox"/>	ON/OFF	597	597	60	575*575	239,44€
10385171004C	35w	3300Lm	5000K	90	0+35	Empotrar	<input type="checkbox"/>	1-10V	597	597	60	575*575	328,63€
10385181004C	35w	3300Lm	5000K	90	0+35	Empotrar	<input type="checkbox"/>	DALI	597	597	60	575*575	313,78€
10383102004C	35w	3300Lm	3000K	90	0+35	Empotrar	<input type="checkbox"/>	ON/OFF	1.197	297	60	1.175*275	239,44€
10383172004C	35w	3300Lm	3000K	90	0+35	Empotrar	<input type="checkbox"/>	1-10V	1.197	297	60	1.175*275	328,63€
10383182004C	35w	3300Lm	3000K	90	0+35	Empotrar	<input type="checkbox"/>	DALI	1.197	297	60	1.175*275	313,78€
10384102004C	35w	3300Lm	4000K	90	0+35	Empotrar	<input type="checkbox"/>	ON/OFF	1.197	297	60	1.175*275	239,44€
10384172004C	35w	3300Lm	4000K	90	0+35	Empotrar	<input type="checkbox"/>	1-10V	1.197	297	60	1.175*275	328,63€
10384182004C	35w	3300Lm	4000K	90	0+35	Empotrar	<input type="checkbox"/>	DALI	1.197	297	60	1.175*275	313,78€
10385102004C	35w	3300Lm	5000K	90	0+35	Empotrar	<input type="checkbox"/>	ON/OFF	1.197	297	60	1.175*275	239,44€
10385172004C	35w	3300Lm	5000K	90	0+35	Empotrar	<input type="checkbox"/>	1-10V	1.197	297	60	1.175*275	328,63€
10385182004C	35w	3300Lm	5000K	90	0+35	Empotrar	<input type="checkbox"/>	DALI	1.197	297	60	1.175*275	313,78€
10383103004C	70w	6600Lm	3000K	90	0+35	Empotrar	<input type="checkbox"/>	ON/OFF	1.197	597	60	1.175*575	478,93€
10383173004C	70w	6600Lm	3000K	90	0+35	Empotrar	<input type="checkbox"/>	1-10V	1.197	597	60	1.175*575	657,26€
10383183004C	70w	6600Lm	3000K	90	0+35	Empotrar	<input type="checkbox"/>	DALI	1.197	597	60	1.175*575	657,56€
10384103004C	70w	6600Lm	4000K	90	0+35	Empotrar	<input type="checkbox"/>	ON/OFF	1.197	597	60	1.175*575	478,93€
10384173004C	70w	6600Lm	4000K	90	0+35	Empotrar	<input type="checkbox"/>	1-10V	1.197	597	60	1.175*575	657,26€
10384183004C	70w	6600Lm	4000K	90	0+35	Empotrar	<input type="checkbox"/>	DALI	1.197	597	60	1.175*575	657,56€
10385103004C	70w	6600Lm	5000K	90	0+35	Empotrar	<input type="checkbox"/>	ON/OFF	1.197	597	60	1.175*575	478,93€
10383173004C	70w	6600Lm	5000K	90	0+35	Empotrar	<input type="checkbox"/>	1-10V	1.197	597	60	1.175*575	657,26€
10385183004C	70w	6600Lm	5000K	90	0+35	Empotrar	<input type="checkbox"/>	DALI	1.197	597	60	1.175*575	657,56€

ACCESORIOS LYSSA

CÓDIGO	DESCRIPCIÓN	PVP
1038ADCG	GARRAS PARA TECHO FIJO	5,26€
1038KE1H	KIT EMERGENCIA 1HORA	222,93€
1038SNS10V	SENSOR 1-10V	79,26€

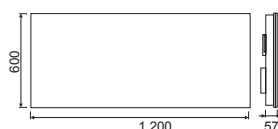
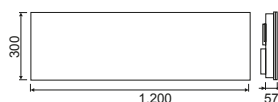
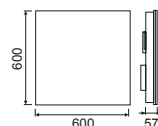

CÓDIGO	W	LM	K	ÓPTICA°		VERSIÓN		ELECTRÓNICA				PVP
									L	W	H	
10383101004S	35w	3300Lm	3000K	90	0+35	Superficie	<input type="checkbox"/>	ON/OFF	600	600	57	262,04€
10383171004S	35w	3300Lm	3000K	90	0+35	Superficie	<input type="checkbox"/>	1-10V	600	600	57	351,22€
10383181004S	35w	3300Lm	3000K	90	0+35	Superficie	<input type="checkbox"/>	DALI	600	600	57	336,37€
10384101004S	35w	3300Lm	4000K	90	0+35	Superficie	<input type="checkbox"/>	ON/OFF	600	600	57	262,04€
10384171004S	35w	3300Lm	4000K	90	0+35	Superficie	<input type="checkbox"/>	1-10V	600	600	57	351,22€
10384181004S	35w	3300Lm	4000K	90	0+35	Superficie	<input type="checkbox"/>	DALI	600	600	57	336,37€
10385101004S	35w	3300Lm	5000K	90	0+35	Superficie	<input type="checkbox"/>	ON/OFF	600	600	57	262,04€
10385171004S	35w	3300Lm	5000K	90	0+35	Superficie	<input type="checkbox"/>	1-10V	600	600	57	351,22€
10385181004S	35w	3300Lm	5000K	90	0+35	Superficie	<input type="checkbox"/>	DALI	600	600	57	336,37€
10383102004S	35w	3300Lm	3000K	90	0+35	Superficie	<input type="checkbox"/>	ON/OFF	1.200	300	57	262,04€
10383172004S	35w	3300Lm	3000K	90	0+35	Superficie	<input type="checkbox"/>	1-10V	1.200	300	57	351,22€
10383182004S	35w	3300Lm	3000K	90	0+35	Superficie	<input type="checkbox"/>	DALI	1.200	300	57	336,37€
10384102004S	35w	3300Lm	4000K	90	0+35	Superficie	<input type="checkbox"/>	ON/OFF	1.200	300	57	262,04€
10384172004S	35w	3300Lm	4000K	90	0+35	Superficie	<input type="checkbox"/>	1-10V	1.200	300	57	351,22€
10384182004S	35w	3300Lm	4000K	90	0+35	Superficie	<input type="checkbox"/>	DALI	1.200	300	57	336,37€
10385102004S	35w	3300Lm	5000K	90	0+35	Superficie	<input type="checkbox"/>	ON/OFF	1.200	300	57	262,04€
10385172004S	35w	3300Lm	5000K	90	0+35	Superficie	<input type="checkbox"/>	1-10V	1.200	300	57	351,22€
10385182004S	35w	3300Lm	5000K	90	0+35	Superficie	<input type="checkbox"/>	DALI	1.200	300	57	336,37€
10383103004S	70w	6600Lm	3000K	90	0+35	Superficie	<input type="checkbox"/>	ON/OFF	1.200	600	57	524,11€
10383173004S	70w	6600Lm	3000K	90	0+35	Superficie	<input type="checkbox"/>	1-10V	1.200	600	57	702,44€
10383183004S	70w	6600Lm	3000K	90	0+35	Superficie	<input type="checkbox"/>	DALI	1.200	600	57	672,70€
10384103004S	70w	6600Lm	4000K	90	0+35	Superficie	<input type="checkbox"/>	ON/OFF	1.200	600	57	524,11€
10384173004S	70w	6600Lm	4000K	90	0+35	Superficie	<input type="checkbox"/>	1-10V	1.200	600	57	702,44€
10384183004S	70w	6600Lm	4000K	90	0+35	Superficie	<input type="checkbox"/>	DALI	1.200	600	57	672,70€
10385103004S	70w	6600Lm	5000K	90	0+35	Superficie	<input type="checkbox"/>	ON/OFF	1.200	600	57	524,11€
10383173004S	70w	6600Lm	5000K	90	0+35	Superficie	<input type="checkbox"/>	1-10V	1.200	600	57	702,44€
10385183004S	70w	6600Lm	5000K	90	0+35	Superficie	<input type="checkbox"/>	DALI	1.200	600	57	672,70€

ACCESORIOS LYSSA

CÓDIGO	DESCRIPCIÓN	PVP
1038KSL	KIT SUSPENSIÓN	79,26€
1038KE1H	KIT EMERGENCIA 1HORA	222,93€
1038SNS10V	SENSOR 1-10V	89,19€

KIRA

TRIDONIC
LEDTRIDONIC
DRIVERIP
20

UGR 19

220-240V
50/60HzChapa
AceroALU+PMMA
Cover

Cri>80

EM



CE

5

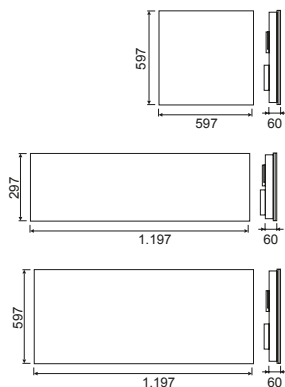
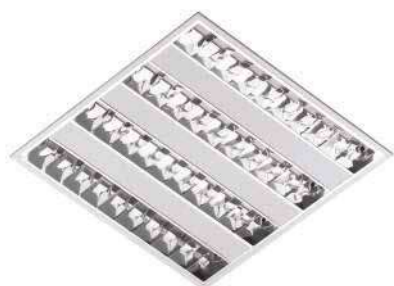

CÓDIGO	W	LM	K	ÓPTICA°		VERSIÓN		ELECTRÓNICA					PVP
									L	W	H		
10383101001C	37w	3300Lm	3000K	90	0+35	Empotrar	<input type="checkbox"/>	ON/OFF	597	597	60	575*575	212,93€
10383171001C	37w	3300Lm	3000K	90	0+35	Empotrar	<input type="checkbox"/>	1-10V	597	597	60	575*575	301,52€
10383181001C	37w	3300Lm	3000K	90	0+35	Empotrar	<input type="checkbox"/>	DALI	597	597	60	575*575	286,67€
10384101001C	37w	3300Lm	4000K	90	0+35	Empotrar	<input type="checkbox"/>	ON/OFF	597	597	60	575*575	212,93€
10384171001C	37w	3300Lm	4000K	90	0+35	Empotrar	<input type="checkbox"/>	1-10V	597	597	60	575*575	301,52€
10384181001C	37w	3300Lm	4000K	90	0+35	Empotrar	<input type="checkbox"/>	DALI	597	597	60	575*575	286,67€
10385101001C	37w	3300Lm	5000K	90	0+35	Empotrar	<input type="checkbox"/>	ON/OFF	597	597	60	575*575	212,93€
10385171001C	37w	3300Lm	5000K	90	0+35	Empotrar	<input type="checkbox"/>	1-10V	597	597	60	575*575	301,52€
10385181001C	37w	3300Lm	5000K	90	0+35	Empotrar	<input type="checkbox"/>	DALI	597	597	60	575*575	286,67€
10383102001C	37w	3300Lm	3000K	90	0+35	Empotrar	<input type="checkbox"/>	ON/OFF	1.197	297	60	1.175*275	212,93€
10383172001C	37w	3300Lm	3000K	90	0+35	Empotrar	<input type="checkbox"/>	1-10V	1.197	297	60	1.175*275	301,52€
10383182001C	37w	3300Lm	3000K	90	0+35	Empotrar	<input type="checkbox"/>	DALI	1.197	297	60	1.175*275	286,67€
10384102001C	37w	3300Lm	4000K	90	0+35	Empotrar	<input type="checkbox"/>	ON/OFF	1.197	297	60	1.175*275	212,93€
10384172001C	37w	3300Lm	4000K	90	0+35	Empotrar	<input type="checkbox"/>	1-10V	1.197	297	60	1.175*275	301,52€
10384182001C	37w	3300Lm	4000K	90	0+35	Empotrar	<input type="checkbox"/>	DALI	1.197	297	60	1.175*275	286,67€
10385102001C	37w	3300Lm	5000K	90	0+35	Empotrar	<input type="checkbox"/>	ON/OFF	1.197	297	60	1.175*275	212,93€
10385172001C	37w	3300Lm	5000K	90	0+35	Empotrar	<input type="checkbox"/>	1-10V	1.197	297	60	1.175*275	301,52€
10385182001C	37w	3300Lm	5000K	90	0+35	Empotrar	<input type="checkbox"/>	DALI	1.197	297	60	1.175*275	286,67€
10383103001C	74w	6600Lm	3000K	90	0+35	Empotrar	<input type="checkbox"/>	ON/OFF	1.197	597	60	1.175*575	424,70€
10383173001C	74w	6600Lm	3000K	90	0+35	Empotrar	<input type="checkbox"/>	1-10V	1.197	597	60	1.175*575	603,04€
10383183001C	74w	6600Lm	3000K	90	0+35	Empotrar	<input type="checkbox"/>	DALI	1.197	597	60	1.175*575	573,33€
10384103001C	74w	6600Lm	4000K	90	0+35	Empotrar	<input type="checkbox"/>	ON/OFF	1.197	597	60	1.175*575	424,70€
10384173001C	74w	6600Lm	4000K	90	0+35	Empotrar	<input type="checkbox"/>	1-10V	1.197	597	60	1.175*575	603,04€
10384183001C	74w	6600Lm	4000K	90	0+35	Empotrar	<input type="checkbox"/>	DALI	1.197	597	60	1.175*575	573,33€
10385103001C	74w	6600Lm	5000K	90	0+35	Empotrar	<input type="checkbox"/>	ON/OFF	1.197	597	60	1.175*575	424,70€
10383173001C	74w	6600Lm	5000K	90	0+35	Empotrar	<input type="checkbox"/>	1-10V	1.197	597	60	1.175*575	603,04€
10385183001C	74w	6600Lm	5000K	90	0+35	Empotrar	<input type="checkbox"/>	DALI	1.197	597	60	1.175*575	573,33€

ACCESORIOS KIRA

CÓDIGO	DESCRIPCIÓN	PVP
1038ADCG	GARRAS PARA TECHO FIJO	5,26€
1038KE1H	KIT EMERGENCIA 1HORA	222,93€
1038SNS10V	SENSOR 1-10V	89,19€

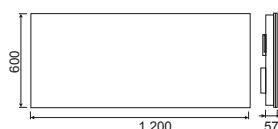
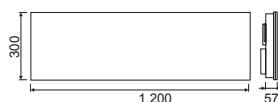
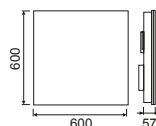

CÓDIGO	W	LM	K	ÓPTICA°		VERSIÓN		ELECTRÓNICA	L	W	H	PVP
10383101001S	37w	3300Lm	3000K	90	0+35	Superficie	<input type="checkbox"/>	ON/OFF	600	600	57	234,93€
10383171001S	37w	3300Lm	3000K	90	0+35	Superficie	<input type="checkbox"/>	1-10V	600	600	57	324,11€
10383181001S	37w	3300Lm	3000K	90	0+35	Superficie	<input type="checkbox"/>	DALI	600	600	57	309,26€
10384101001S	37w	3300Lm	4000K	90	0+35	Superficie	<input type="checkbox"/>	ON/OFF	600	600	57	234,93€
10384171001S	37w	3300Lm	4000K	90	0+35	Superficie	<input type="checkbox"/>	1-10V	600	600	57	324,11€
10384181001S	37w	3300Lm	4000K	90	0+35	Superficie	<input type="checkbox"/>	DALI	600	600	57	309,26€
10385101001S	37w	3300Lm	5000K	90	0+35	Superficie	<input type="checkbox"/>	ON/OFF	600	600	57	234,93€
10385171001S	37w	3300Lm	5000K	90	0+35	Superficie	<input type="checkbox"/>	1-10V	600	600	57	324,11€
10385181001S	37w	3300Lm	5000K	90	0+35	Superficie	<input type="checkbox"/>	DALI	600	600	57	309,26€
10383102001S	37w	3300Lm	3000K	90	0+35	Superficie	<input type="checkbox"/>	ON/OFF	1.200	300	57	234,93€
10383172001S	37w	3300Lm	3000K	90	0+35	Superficie	<input type="checkbox"/>	1-10V	1.200	300	57	324,11€
10383182001S	37w	3300Lm	3000K	90	0+35	Superficie	<input type="checkbox"/>	DALI	1.200	300	57	309,26€
10384102001S	37w	3300Lm	4000K	90	0+35	Superficie	<input type="checkbox"/>	ON/OFF	1.200	300	57	234,93€
10384172001S	37w	3300Lm	4000K	90	0+35	Superficie	<input type="checkbox"/>	1-10V	1.200	300	57	324,11€
10384182001S	37w	3300Lm	4000K	90	0+35	Superficie	<input type="checkbox"/>	DALI	1.200	300	57	309,26€
10385102001S	37w	3300Lm	5000K	90	0+35	Superficie	<input type="checkbox"/>	ON/OFF	1.200	300	57	234,93€
10385172001S	37w	3300Lm	5000K	90	0+35	Superficie	<input type="checkbox"/>	1-10V	1.200	300	57	324,11€
10385182001S	37w	3300Lm	5000K	90	0+35	Superficie	<input type="checkbox"/>	DALI	1.200	300	57	309,26€
10383103001S	74w	6600Lm	3000K	90	0+35	Superficie	<input type="checkbox"/>	ON/OFF	1.200	600	57	469,89€
10383173001S	74w	6600Lm	3000K	90	0+35	Superficie	<input type="checkbox"/>	1-10V	1.200	600	57	648,22€
10383183001S	74w	6600Lm	3000K	90	0+35	Superficie	<input type="checkbox"/>	DALI	1.200	600	57	618,52€
10384103001S	74w	6600Lm	4000K	90	0+35	Superficie	<input type="checkbox"/>	ON/OFF	1.200	600	57	469,89€
10384173001S	74w	6600Lm	4000K	90	0+35	Superficie	<input type="checkbox"/>	1-10V	1.200	600	57	648,22€
10384183001S	74w	6600Lm	4000K	90	0+35	Superficie	<input type="checkbox"/>	DALI	1.200	600	57	618,52€
10385103001S	74w	6600Lm	5000K	90	0+35	Superficie	<input type="checkbox"/>	ON/OFF	1.200	600	57	469,89€
10383173001S	74w	6600Lm	5000K	90	0+35	Superficie	<input type="checkbox"/>	1-10V	1.200	600	57	648,22€
10385183001S	74w	6600Lm	5000K	90	0+35	Superficie	<input type="checkbox"/>	DALI	1.200	600	57	618,52€

ACCESORIOS KIRA

CÓDIGO	DESCRIPCIÓN	PVP
1038KSCOV	KIT SUSPENSIÓN	79,26€
1038KE1H	KIT EMERGENCIA 1HORA	222,93€
1038SNS10V	SENSOR 1-10V	89,19€

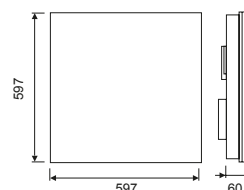

CÓDIGO	W	LM	K	ÓPTICA°	°C	VERSIÓN		ELECTRÓNICA					PVP
									L	W	H		
10383101001I	35w	2600Lm	3000K	120	0+35	Empotrar	<input type="checkbox"/>	ON/OFF	597	597	60	575*575	351,93€
10383171001I	35w	2600Lm	3000K	120	0+35	Empotrar	<input type="checkbox"/>	1-10V	597	597	60	575*575	441,11€
10383181001I	35w	2600Lm	3000K	120	0+35	Empotrar	<input type="checkbox"/>	DALI	597	597	60	575*575	426,26€
10384101001I	35w	2600Lm	4000K	120	0+35	Empotrar	<input type="checkbox"/>	ON/OFF	597	597	60	575*575	351,93€
10384171001I	35w	2600Lm	4000K	120	0+35	Empotrar	<input type="checkbox"/>	1-10V	597	597	60	575*575	441,11€
10384181001I	35w	2600Lm	4000K	120	0+35	Empotrar	<input type="checkbox"/>	DALI	597	597	60	575*575	426,26€
10385101001I	35w	2600Lm	5000K	120	0+35	Empotrar	<input type="checkbox"/>	ON/OFF	597	597	60	575*575	351,93€
10385171001I	35w	2600Lm	5000K	120	0+35	Empotrar	<input type="checkbox"/>	1-10V	597	597	60	575*575	441,11€
10385181001I	35w	2600Lm	5000K	120	0+35	Empotrar	<input type="checkbox"/>	DALI	597	597	60	575*575	426,26€
10383101002I	35w	2600Lm	3000K	120	0+35	Empotrar	<input type="checkbox"/>	ON/OFF	597	597	60	575*575	375,70€
10383171002I	35w	2600Lm	3000K	120	0+35	Empotrar	<input type="checkbox"/>	1-10V	597	597	60	575*575	464,89€
10383181002I	35w	2600Lm	3000K	120	0+35	Empotrar	<input type="checkbox"/>	DALI	597	597	60	575*575	450,04€
10384101002I	35w	2600Lm	4000K	120	0+35	Empotrar	<input type="checkbox"/>	ON/OFF	597	597	60	575*575	375,70€
10384171002I	35w	2600Lm	4000K	120	0+35	Empotrar	<input type="checkbox"/>	1-10V	597	597	60	575*575	464,89€
10384181002I	35w	2600Lm	4000K	120	0+35	Empotrar	<input type="checkbox"/>	DALI	597	597	60	575*575	450,04€
10385101002I	35w	2600Lm	5000K	120	0+35	Empotrar	<input type="checkbox"/>	ON/OFF	597	597	60	575*575	375,70€
10385171002I	35w	2600Lm	5000K	120	0+35	Empotrar	<input type="checkbox"/>	1-10V	597	597	60	575*575	464,89€
10385181002I	35w	2600Lm	5000K	120	0+35	Empotrar	<input type="checkbox"/>	DALI	597	597	60	575*575	450,04€

ACCESORIOS KAREN

CÓDIGO	DESCRIPCIÓN	PVP
1038ADCG	GARRAS PARA TECHO FIJO	5,26€
1038KE1H	KIT EMERGENCIA 1HORA	222,93€
1038SNS10V	SENSOR 1-10V	89,19€

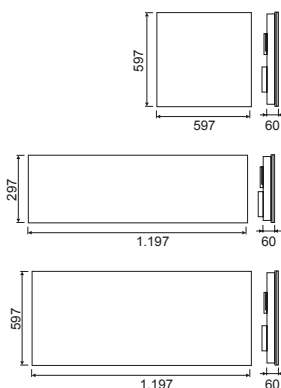

CÓDIGO	W	LM	K	ÓPTICA°		VERSIÓN		ELECTRÓNICA					PVP
									L	W	H		
10383101003C	45w	4800Lm	3000K	120	0+35	Empotrar	<input type="checkbox"/>	ON/OFF	597	597	60	575*575	234,93€
10383171003C	45w	4800Lm	3000K	120	0+35	Empotrar	<input type="checkbox"/>	1-10V	597	597	60	575*575	324,11€
10383181003C	45w	4800Lm	3000K	120	0+35	Empotrar	<input type="checkbox"/>	DALI	597	597	60	575*575	309,26€
10384101003C	45w	4800Lm	4000K	120	0+35	Empotrar	<input type="checkbox"/>	ON/OFF	597	597	60	575*575	234,93€
10384171003C	45w	4800Lm	4000K	120	0+35	Empotrar	<input type="checkbox"/>	1-10V	597	597	60	575*575	324,11€
10384181003C	45w	4800Lm	4000K	120	0+35	Empotrar	<input type="checkbox"/>	DALI	597	597	60	575*575	309,26€
10385101003C	45w	4800Lm	5000K	120	0+35	Empotrar	<input type="checkbox"/>	ON/OFF	597	597	60	575*575	234,93€
10385171003C	45w	4800Lm	5000K	120	0+35	Empotrar	<input type="checkbox"/>	1-10V	597	597	60	575*575	324,11€
10385181003C	45w	4800Lm	5000K	120	0+35	Empotrar	<input type="checkbox"/>	DALI	597	597	60	575*575	309,26€
10383102003C	45w	4800Lm	3000K	120	0+35	Empotrar	<input type="checkbox"/>	ON/OFF	1.197	297	60	1.175*275	234,93€
10383172003C	45w	4800Lm	3000K	120	0+35	Empotrar	<input type="checkbox"/>	1-10V	1.197	297	60	1.175*275	324,11€
10383182003C	45w	4800Lm	3000K	120	0+35	Empotrar	<input type="checkbox"/>	DALI	1.197	297	60	1.175*275	309,26€
10384102003C	45w	4800Lm	4000K	120	0+35	Empotrar	<input type="checkbox"/>	ON/OFF	1.197	297	60	1.175*275	234,93€
10384172003C	45w	4800Lm	4000K	120	0+35	Empotrar	<input type="checkbox"/>	1-10V	1.197	297	60	1.175*275	324,11€
10384182003C	45w	4800Lm	4000K	120	0+35	Empotrar	<input type="checkbox"/>	DALI	1.197	297	60	1.175*275	309,26€
10385102003C	45w	4800Lm	5000K	120	0+35	Empotrar	<input type="checkbox"/>	ON/OFF	1.197	297	60	1.175*275	234,93€
10385172003C	45w	4800Lm	5000K	120	0+35	Empotrar	<input type="checkbox"/>	1-10V	1.197	297	60	1.175*275	324,11€
10385182003C	45w	4800Lm	5000K	120	0+35	Empotrar	<input type="checkbox"/>	DALI	1.197	297	60	1.175*275	309,26€
10383103003C	90w	9600Lm	3000K	120	0+35	Empotrar	<input type="checkbox"/>	ON/OFF	1.197	597	60	1.175*575	469,89€
10383173003C	90w	9600Lm	3000K	120	0+35	Empotrar	<input type="checkbox"/>	1-10V	1.197	597	60	1.175*575	648,22€
10383183003C	90w	9600Lm	3000K	120	0+35	Empotrar	<input type="checkbox"/>	DALI	1.197	597	60	1.175*575	618,52€
10384103003C	90w	9600Lm	4000K	120	0+35	Empotrar	<input type="checkbox"/>	ON/OFF	1.197	597	60	1.175*575	469,89€
10384173003C	90w	9600Lm	4000K	120	0+35	Empotrar	<input type="checkbox"/>	1-10V	1.197	597	60	1.175*575	648,22€
10384183003C	90w	9600Lm	4000K	120	0+35	Empotrar	<input type="checkbox"/>	DALI	1.197	597	60	1.175*575	618,52€
10385103003C	90w	9600Lm	5000K	120	0+35	Empotrar	<input type="checkbox"/>	ON/OFF	1.197	597	60	1.175*575	469,89€
10385173003C	90w	9600Lm	5000K	120	0+35	Empotrar	<input type="checkbox"/>	1-10V	1.197	597	60	1.175*575	648,22€
10385183003C	90w	9600Lm	5000K	120	0+35	Empotrar	<input type="checkbox"/>	DALI	1.197	597	60	1.175*575	618,52€

ACCESORIOS XENIA

CÓDIGO	DESCRIPCIÓN	PVP
1038ADCG	GARRAS PARA TECHO FIJO	5,26€
1038KE1H	KIT EMERGENCIA 1HORA	222,93€
1038SNS10V	SENSOR 1-10V	89,19€

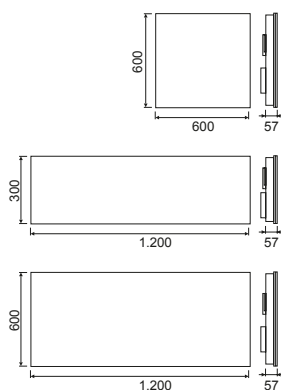

CÓDIGO	W	LM	K	ÓPTICA°		VERSIÓN		ELECTRÓNICA				PVP
									L	W	H	
10383101003S	45w	4800Lm	3000K	120	0+35	Superficie	B <input type="checkbox"/>	ON/OFF	600	600	57	253,00€
10383171003S	45w	4800Lm	3000K	120	0+35	Superficie	B <input type="checkbox"/>	1-10V	600	600	57	342,19€
10383181003S	45w	4800Lm	3000K	120	0+35	Superficie	B <input type="checkbox"/>	DALI	600	600	57	327,33€
10384101003S	45w	4800Lm	4000K	120	0+35	Superficie	B <input type="checkbox"/>	ON/OFF	600	600	57	253,00€
10384171003S	45w	4800Lm	4000K	120	0+35	Superficie	B <input type="checkbox"/>	1-10V	600	600	57	342,19€
10384181003S	45w	4800Lm	4000K	120	0+35	Superficie	B <input type="checkbox"/>	DALI	600	600	57	327,33€
10385101003S	45w	4800Lm	5000K	120	0+35	Superficie	B <input type="checkbox"/>	ON/OFF	600	600	57	253,00€
10385171003S	45w	4800Lm	5000K	120	0+35	Superficie	B <input type="checkbox"/>	1-10V	600	600	57	342,19€
10385181003S	45w	4800Lm	5000K	120	0+35	Superficie	B <input type="checkbox"/>	DALI	600	600	57	327,33€
10383102003S	45w	4800Lm	3000K	120	0+35	Superficie	B <input type="checkbox"/>	ON/OFF	1.200	300	57	253,00€
10383172003S	45w	4800Lm	3000K	120	0+35	Superficie	B <input type="checkbox"/>	1-10V	1.200	300	57	342,19€
10383182003S	45w	4800Lm	3000K	120	0+35	Superficie	B <input type="checkbox"/>	DALI	1.200	300	57	327,33€
10384102003S	45w	4800Lm	4000K	120	0+35	Superficie	B <input type="checkbox"/>	ON/OFF	1.200	300	57	253,00€
10384172003S	45w	4800Lm	4000K	120	0+35	Superficie	B <input type="checkbox"/>	1-10V	1.200	300	57	342,19€
10384182003S	45w	4800Lm	4000K	120	0+35	Superficie	B <input type="checkbox"/>	DALI	1.200	300	57	327,33€
10385102003S	45w	4800Lm	5000K	120	0+35	Superficie	B <input type="checkbox"/>	ON/OFF	1.200	300	57	253,00€
10385172003S	45w	4800Lm	5000K	120	0+35	Superficie	B <input type="checkbox"/>	1-10V	1.200	300	57	342,19€
10385182003S	45w	4800Lm	5000K	120	0+35	Superficie	B <input type="checkbox"/>	DALI	1.200	300	57	327,33€
10383103003S	90w	9600Lm	3000K	120	0+35	Superficie	B <input type="checkbox"/>	ON/OFF	1.200	600	57	506,04€
10383173003S	90w	9600Lm	3000K	120	0+35	Superficie	B <input type="checkbox"/>	1-10V	1.200	600	57	684,37€
10383183003S	90w	9600Lm	3000K	120	0+35	Superficie	B <input type="checkbox"/>	DALI	1.200	600	57	654,63€
10384103003S	90w	9600Lm	4000K	120	0+35	Superficie	B <input type="checkbox"/>	ON/OFF	1.200	600	57	506,04€
10384173003S	90w	9600Lm	4000K	120	0+35	Superficie	B <input type="checkbox"/>	1-10V	1.200	600	57	684,37€
10384183003S	90w	9600Lm	4000K	120	0+35	Superficie	B <input type="checkbox"/>	DALI	1.200	600	57	654,63€
10385103003S	90w	9600Lm	5000K	120	0+35	Superficie	B <input type="checkbox"/>	ON/OFF	1.200	600	57	506,04€
10385173003S	90w	9600Lm	5000K	120	0+35	Superficie	B <input type="checkbox"/>	1-10V	1.200	600	57	684,37€
10385183003S	90w	9600Lm	5000K	120	0+35	Superficie	B <input type="checkbox"/>	DALI	1.200	600	57	654,63€

ACCESORIOS XENIA

CÓDIGO	DESCRIPCIÓN	PVP
1038KSXEN	KIT SUSPENSIÓN	79,26€
1038KE1H	KIT EMERGENCIA 1HORA	222,93€
1038SNS10V	SENSOR 1-10V	89,19€

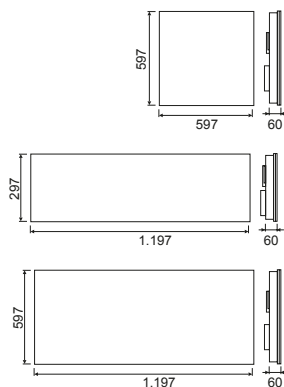
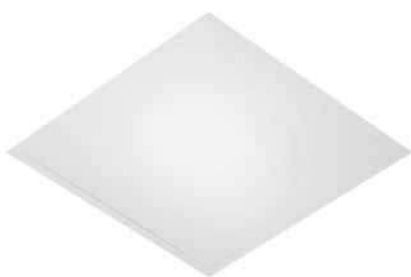

CÓDIGO	W	Lm	K	ÓPTICA°	VERSIÓN	ELECTRÓNICA	ELECTRÓNICA			PVP			
							L	W	H				
10383101003CDMP	45w	4900Lm	3000K	120	0+35	Empotrar	B	ON/OFF	597	597	60	575*575	253,00€
10383171003CDMP	45w	4900Lm	3000K	120	0+35	Empotrar	B	1-10V	597	597	60	575*575	342,19€
10383181003CDMP	45w	4900Lm	3000K	120	0+35	Empotrar	B	DALI	597	597	60	575*575	327,33€
10384101003CDMP	45w	4900Lm	4000K	120	0+35	Empotrar	B	ON/OFF	597	597	60	575*575	253,00€
10384171003CDMP	45w	4900Lm	4000K	120	0+35	Empotrar	B	1-10V	597	597	60	575*575	342,19€
10384181003CDMP	45w	4900Lm	4000K	120	0+35	Empotrar	B	DALI	597	597	60	575*575	327,33€
10385101003CDMP	45w	4900Lm	5000K	120	0+35	Empotrar	B	ON/OFF	597	597	60	575*575	253,00€
10385171003CDMP	45w	4900Lm	5000K	120	0+35	Empotrar	B	1-10V	597	597	60	575*575	342,19€
10385181003CDMP	45w	4900Lm	5000K	120	0+35	Empotrar	B	DALI	597	597	60	575*575	327,33€
10383102003CDMP	45w	4900Lm	3000K	120	0+35	Empotrar	B	ON/OFF	1.197	297	60	1.175*275	253,00€
10383172003CDMP	45w	4900Lm	3000K	120	0+35	Empotrar	B	1-10V	1.197	297	60	1.175*275	342,19€
10383182003CDMP	45w	4900Lm	3000K	120	0+35	Empotrar	B	DALI	1.197	297	60	1.175*275	327,33€
10384102003CDMP	45w	4900Lm	4000K	120	0+35	Empotrar	B	ON/OFF	1.197	297	60	1.175*275	253,00€
10384172003CDMP	45w	4900Lm	4000K	120	0+35	Empotrar	B	1-10V	1.197	297	60	1.175*275	342,19€
10384182003CDMP	45w	4900Lm	4000K	120	0+35	Empotrar	B	DALI	1.197	297	60	1.175*275	327,33€
10385102003CDMP	45w	4900Lm	5000K	120	0+35	Empotrar	B	ON/OFF	1.197	297	60	1.175*275	253,00€
10385172003CDMP	45w	4900Lm	5000K	120	0+35	Empotrar	B	1-10V	1.197	297	60	1.175*275	342,19€
10385182003CDMP	45w	4900Lm	5000K	120	0+35	Empotrar	B	DALI	1.197	297	60	1.175*275	327,33€
10383103003CDMP	90w	9800Lm	3000K	120	0+35	Empotrar	B	ON/OFF	1.197	597	60	1.175*575	506,04€
10383173003CDMP	90w	9800Lm	3000K	120	0+35	Empotrar	B	1-10V	1.197	597	60	1.175*575	684,37€
10383183003CDMP	90w	9800Lm	3000K	120	0+35	Empotrar	B	DALI	1.197	597	60	1.175*575	654,63€
10384103003CDMP	90w	9800Lm	4000K	120	0+35	Empotrar	B	ON/OFF	1.197	597	60	1.175*575	506,04€
10384173003CDMP	90w	9800Lm	4000K	120	0+35	Empotrar	B	1-10V	1.197	597	60	1.175*575	684,37€
10384183003CDMP	90w	9800Lm	4000K	120	0+35	Empotrar	B	DALI	1.197	597	60	1.175*575	654,63€
10385103003CDMP	90w	9800Lm	5000K	120	0+35	Empotrar	B	ON/OFF	1.197	597	60	1.175*575	506,04€
10385173003CDMP	90w	9800Lm	5000K	120	0+35	Empotrar	B	1-10V	1.197	597	60	1.175*575	684,37€
10385183003CDMP	90w	9800Lm	5000K	120	0+35	Empotrar	B	DALI	1.197	597	60	1.175*575	654,63€

ACCESORIOS XENIA

CÓDIGO	DESCRIPCIÓN	PVP
1038ADCG	GARRAS PARA TECHO FIJO	5,26€
1038KE1H	KIT EMERGENCIA 1HORA	222,93€
1038SNS10V	SENSOR 1-10V	89,19€

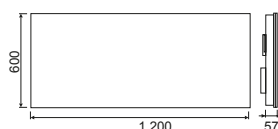
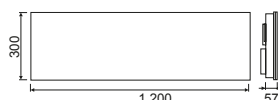
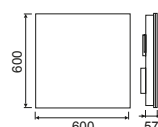

CÓDIGO	W	LM	K	ÓPTICA°		VERSIÓN		ELECTRÓNICA				PVP
									L	W	H	
10383101003SDMP	45w	4900Lm	3000K	90	0+35	Superficie	B <input type="checkbox"/>	ON/OFF	600	600	57	275,59€
10383171003SDMP	45w	4900Lm	3000K	90	0+35	Superficie	B <input type="checkbox"/>	1-10V	600	600	57	364,78€
10383181003SDMP	45w	4900Lm	3000K	90	0+35	Superficie	B <input type="checkbox"/>	DALI	600	600	57	349,93€
10384101003SDMP	45w	4900Lm	4000K	90	0+35	Superficie	B <input type="checkbox"/>	ON/OFF	600	600	57	275,59€
10384171003SDMP	45w	4900Lm	4000K	90	0+35	Superficie	B <input type="checkbox"/>	1-10V	600	600	57	364,78€
10384181003SDMP	45w	4900Lm	4000K	90	0+35	Superficie	B <input type="checkbox"/>	DALI	600	600	57	349,93€
10385101003SDMP	45w	4900Lm	5000K	90	0+35	Superficie	B <input type="checkbox"/>	ON/OFF	600	600	57	275,59€
10385171003SDMP	45w	4900Lm	5000K	90	0+35	Superficie	B <input type="checkbox"/>	1-10V	600	600	57	364,78€
10385181003SDMP	45w	4900Lm	5000K	90	0+35	Superficie	B <input type="checkbox"/>	DALI	600	600	57	349,93€
10383102003SDMP	45w	4900Lm	3000K	90	0+35	Superficie	B <input type="checkbox"/>	ON/OFF	1.200	300	57	275,59€
10383172003SDMP	45w	4900Lm	3000K	90	0+35	Superficie	B <input type="checkbox"/>	1-10V	1.200	300	57	364,78€
10383182003SDMP	45w	4900Lm	3000K	90	0+35	Superficie	B <input type="checkbox"/>	DALI	1.200	300	57	349,93€
10384102003SDMP	45w	4900Lm	4000K	90	0+35	Superficie	B <input type="checkbox"/>	ON/OFF	1.200	300	57	275,59€
10384172003SDMP	45w	4900Lm	4000K	90	0+35	Superficie	B <input type="checkbox"/>	1-10V	1.200	300	57	364,78€
10384182003SDMP	45w	4900Lm	4000K	90	0+35	Superficie	B <input type="checkbox"/>	DALI	1.200	300	57	349,93€
10385102003SDMP	45w	4900Lm	5000K	90	0+35	Superficie	B <input type="checkbox"/>	ON/OFF	1.200	300	57	275,59€
10385172003SDMP	45w	4900Lm	5000K	90	0+35	Superficie	B <input type="checkbox"/>	1-10V	1.200	300	57	364,78€
10385182003SDMP	45w	4900Lm	5000K	90	0+35	Superficie	B <input type="checkbox"/>	DALI	1.200	300	57	349,93€
10383103003SDMP	90w	9800Lm	3000K	90	0+35	Superficie	B <input type="checkbox"/>	ON/OFF	1.200	600	57	551,22€
10383173003SDMP	90w	9800Lm	3000K	90	0+35	Superficie	B <input type="checkbox"/>	1-10V	1.200	600	57	729,56€
10383183003SDMP	90w	9800Lm	3000K	90	0+35	Superficie	B <input type="checkbox"/>	DALI	1.200	600	57	669,81€
10384103003SDMP	90w	9800Lm	4000K	90	0+35	Superficie	B <input type="checkbox"/>	ON/OFF	1.200	600	57	551,22€
10384173003SDMP	90w	9800Lm	4000K	90	0+35	Superficie	B <input type="checkbox"/>	1-10V	1.200	600	57	729,56€
10384183003SDMP	90w	9800Lm	4000K	90	0+35	Superficie	B <input type="checkbox"/>	DALI	1.200	600	57	669,81€
10385103003SDMP	90w	9800Lm	5000K	90	0+35	Superficie	B <input type="checkbox"/>	ON/OFF	1.200	600	57	551,22€
10385173003SDMP	90w	9800Lm	5000K	90	0+35	Superficie	B <input type="checkbox"/>	1-10V	1.200	600	57	729,56€
10385183003SDMP	90w	9800Lm	5000K	90	0+35	Superficie	B <input type="checkbox"/>	DALI	1.200	600	57	669,81€

ACCESORIOS XENIA

CÓDIGO	DESCRIPCIÓN	PVP
1038KSXEN	KIT SUSPENSIÓN	79,26€
1038KE1H	KIT EMERGENCIA 1HORA	222,93€
1038SNS10V	SENSOR 1-10V	89,19€



LYOPRO
LEVEL

LUMINARIAS SALAS LIMPIAS
CLEAN ROOMS LUMINAIRES
LUMINAIRES POUR SALLES BLANCHES

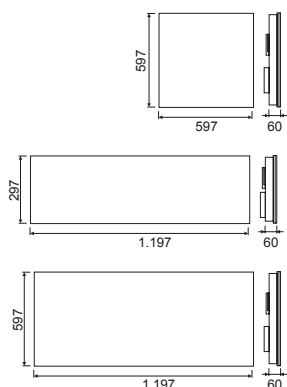

CÓDIGO	W	LM	K	ÓPTICA°	°C	VERSIÓN	ELECTRÓNICA	DIMENSIONES			PVP		
								L	W	H			
10383101012C	45w	4500Lm	3000K	120	0+35	Empotrar	B <input type="checkbox"/>	ON/OFF	597	597	60	575*575	291,07€
10383171012C	45w	4500Lm	3000K	120	0+35	Empotrar	B <input type="checkbox"/>	1-10V	597	597	60	575*575	380,22€
10383181012C	45w	4500Lm	3000K	120	0+35	Empotrar	B <input type="checkbox"/>	DALI	597	597	60	575*575	365,37€
10384101012C	45w	4500Lm	4000K	120	0+35	Empotrar	B <input type="checkbox"/>	ON/OFF	597	597	60	575*575	291,07€
10384171012C	45w	4500Lm	4000K	120	0+35	Empotrar	B <input type="checkbox"/>	1-10V	597	597	60	575*575	380,22€
10384181012C	45w	4500Lm	4000K	120	0+35	Empotrar	B <input type="checkbox"/>	DALI	597	597	60	575*575	365,37€
10385101012C	45w	4500Lm	5000K	120	0+35	Empotrar	B <input type="checkbox"/>	ON/OFF	597	597	60	575*575	291,07€
10385171012C	45w	4500Lm	5000K	120	0+35	Empotrar	B <input type="checkbox"/>	1-10V	597	597	60	575*575	380,22€
10385181012C	45w	4500Lm	5000K	120	0+35	Empotrar	B <input type="checkbox"/>	DALI	597	597	60	575*575	365,37€
10383102012C	45w	4500Lm	3000K	120	0+35	Empotrar	B <input type="checkbox"/>	ON/OFF	1.197	297	60	1.175*275	291,07€
10383172012C	45w	4500Lm	3000K	120	0+35	Empotrar	B <input type="checkbox"/>	1-10V	1.197	297	60	1.175*275	380,22€
10383182012C	45w	4500Lm	3000K	120	0+35	Empotrar	B <input type="checkbox"/>	DALI	1.197	297	60	1.175*275	365,37€
10384102012C	45w	4500Lm	4000K	120	0+35	Empotrar	B <input type="checkbox"/>	ON/OFF	1.197	297	60	1.175*275	291,07€
10384172012C	45w	4500Lm	4000K	120	0+35	Empotrar	B <input type="checkbox"/>	1-10V	1.197	297	60	1.175*275	380,22€
10384182012C	45w	4500Lm	4000K	120	0+35	Empotrar	B <input type="checkbox"/>	DALI	1.197	297	60	1.175*275	365,37€
10385102012C	45w	4500Lm	5000K	120	0+35	Empotrar	B <input type="checkbox"/>	ON/OFF	1.197	297	60	1.175*275	291,07€
10385172012C	45w	4500Lm	5000K	120	0+35	Empotrar	B <input type="checkbox"/>	1-10V	1.197	297	60	1.175*275	380,22€
10385182012C	45w	4500Lm	5000K	120	0+35	Empotrar	B <input type="checkbox"/>	DALI	1.197	297	60	1.175*275	365,37€
10383103012C	90w	9000Lm	3000K	120	0+35	Empotrar	B <input type="checkbox"/>	ON/OFF	1.197	597	60	1.175*575	291,07€
10383173012C	90w	9000Lm	3000K	120	0+35	Empotrar	B <input type="checkbox"/>	1-10V	1.197	597	60	1.175*575	380,22€
10383183012C	90w	9000Lm	3000K	120	0+35	Empotrar	B <input type="checkbox"/>	DALI	1.197	597	60	1.175*575	365,37€
10384103012C	90w	9000Lm	4000K	120	0+35	Empotrar	B <input type="checkbox"/>	ON/OFF	1.197	597	60	1.175*575	291,07€
10384173012C	90w	9000Lm	4000K	120	0+35	Empotrar	B <input type="checkbox"/>	1-10V	1.197	597	60	1.175*575	380,22€
10384183012C	90w	9000Lm	4000K	120	0+35	Empotrar	B <input type="checkbox"/>	DALI	1.197	597	60	1.175*575	365,37€
10385103012C	90w	9000Lm	5000K	120	0+35	Empotrar	B <input type="checkbox"/>	ON/OFF	1.197	597	60	1.175*575	291,07€
10385173012C	90w	9000Lm	5000K	120	0+35	Empotrar	B <input type="checkbox"/>	1-10V	1.197	597	60	1.175*575	380,22€
10385183012C	90w	9000Lm	5000K	120	0+35	Empotrar	B <input type="checkbox"/>	DALI	1.197	597	60	1.175*575	365,37€

ACCESORIOS DALAI

CÓDIGO	DESCRIPCIÓN	PVP
1038KE1H	KIT EMERGENCIA 1HORA	222,93€
1038SNS10V	SENSOR 1-10V	89,19€

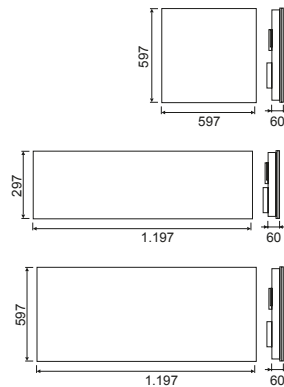
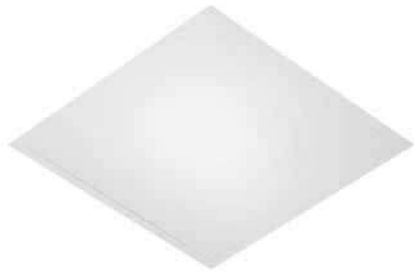

CÓDIGO	W	LM	K	ÓPTICA°		VERSIÓN		ELECTRÓNICA					PVP
									L	W	H		
10383101022C	45w	4500Lm	3000K	120	0+35	Empotrar	B <input type="checkbox"/>	ON/OFF	597	597	60	575*575	577,85€
10383171022C	45w	4500Lm	3000K	120	0+35	Empotrar	B <input type="checkbox"/>	1-10V	597	597	60	575*575	667,00€
10383181022C	45w	4500Lm	3000K	120	0+35	Empotrar	B <input type="checkbox"/>	DALI	597	597	60	575*575	652,15€
10384101022C	45w	4500Lm	4000K	120	0+35	Empotrar	B <input type="checkbox"/>	ON/OFF	597	597	60	575*575	577,85€
10384171022C	45w	4500Lm	4000K	120	0+35	Empotrar	B <input type="checkbox"/>	1-10V	597	597	60	575*575	667,00€
10384181022C	45w	4500Lm	4000K	120	0+35	Empotrar	B <input type="checkbox"/>	DALI	597	597	60	575*575	652,15€
10385101022C	45w	4500Lm	5000K	120	0+35	Empotrar	B <input type="checkbox"/>	ON/OFF	597	597	60	575*575	577,85€
10385171022C	45w	4500Lm	5000K	120	0+35	Empotrar	B <input type="checkbox"/>	1-10V	597	597	60	575*575	667,00€
10385181022C	45w	4500Lm	5000K	120	0+35	Empotrar	B <input type="checkbox"/>	DALI	597	597	60	575*575	652,15€
10383102022C	45w	4500Lm	3000K	120	0+35	Empotrar	B <input type="checkbox"/>	ON/OFF	1.197	297	60	1.175*275	577,85€
10383172022C	45w	4500Lm	3000K	120	0+35	Empotrar	B <input type="checkbox"/>	1-10V	1.197	297	60	1.175*275	667,00€
10383182022C	45w	4500Lm	3000K	120	0+35	Empotrar	B <input type="checkbox"/>	DALI	1.197	297	60	1.175*275	652,15€
10384102022C	45w	4500Lm	4000K	120	0+35	Empotrar	B <input type="checkbox"/>	ON/OFF	1.197	297	60	1.175*275	577,85€
10384172022C	45w	4500Lm	4000K	120	0+35	Empotrar	B <input type="checkbox"/>	1-10V	1.197	297	60	1.175*275	667,00€
10384182022C	45w	4500Lm	4000K	120	0+35	Empotrar	B <input type="checkbox"/>	DALI	1.197	297	60	1.175*275	652,15€
10385102022C	45w	4500Lm	5000K	120	0+35	Empotrar	B <input type="checkbox"/>	ON/OFF	1.197	297	60	1.175*275	577,85€
10385172022C	45w	4500Lm	5000K	120	0+35	Empotrar	B <input type="checkbox"/>	1-10V	1.197	297	60	1.175*275	667,00€
10385182022C	45w	4500Lm	5000K	120	0+35	Empotrar	B <input type="checkbox"/>	DALI	1.197	297	60	1.175*275	652,15€
10383103022C	90w	9000Lm	3000K	120	0+35	Empotrar	B <input type="checkbox"/>	ON/OFF	1.197	597	60	1.175*575	1155,67€
10383173022C	90w	9000Lm	3000K	120	0+35	Empotrar	B <input type="checkbox"/>	1-10V	1.197	597	60	1.175*575	1334,04€
10383183022C	90w	9000Lm	3000K	120	0+35	Empotrar	B <input type="checkbox"/>	DALI	1.197	597	60	1.175*575	1304,30€
10384103022C	90w	9000Lm	4000K	120	0+35	Empotrar	B <input type="checkbox"/>	ON/OFF	1.197	597	60	1.175*575	1155,67€
10384173022C	90w	9000Lm	4000K	120	0+35	Empotrar	B <input type="checkbox"/>	1-10V	1.197	597	60	1.175*575	1334,04€
10384183022C	90w	9000Lm	4000K	120	0+35	Empotrar	B <input type="checkbox"/>	DALI	1.197	597	60	1.175*575	1304,30€
10385103022C	90w	9000Lm	5000K	120	0+35	Empotrar	B <input type="checkbox"/>	ON/OFF	1.197	597	60	1.175*575	1155,67€
10385173022C	90w	9000Lm	5000K	120	0+35	Empotrar	B <input type="checkbox"/>	1-10V	1.197	597	60	1.175*575	1334,04€
10385183022C	90w	9000Lm	5000K	120	0+35	Empotrar	B <input type="checkbox"/>	DALI	1.197	597	60	1.175*575	1304,30€

ACCESORIOS TELEM

CÓDIGO	DESCRIPCIÓN	PVP
1038KE1H	KIT EMERGENCIA 1HORA	222,93€
1038SNS10V	SENSOR 1-10V	89,19€

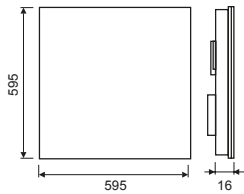

CÓDIGO	W	LM	K	ÓPTICA°	Ra/CRI						ELECTRÓNICA	PVP
								L	W	H		
60730	40w	4000Lm	4000K	110	>80	-20+40	B	595	595	16	1-10V	322,47€
60732	40w	4000Lm	4000K	110	>80	-20+40	B	595	595	16	DALI	343,92€





LYOPRO
LEVEL

LUMINARIA PISABLE PARA TECHOS TÉCNICOS
WALKABLE LUMINAIRE FOR TECHNICAL CEILINGS
LUMINAIRE MARCHABLE POUR PLAFONDS TECHNIQUES

HESTER

TRIDONIC
LED

TRIDONIC
DRIVER

IP
20

UGR 22



220-240V
50/60Hz

Chapa
Acero

PMMA OPAL
Cover

Cri>80

EM

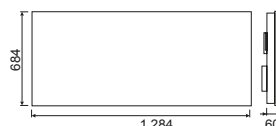
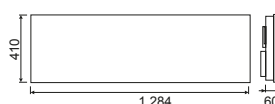
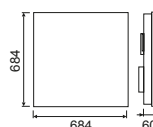

CÓDIGO	W	LM	K	ÓPTICA°		VERSIÓN		ELECTRÓNICA					PVP
									L	W	H		
10383101012CVP	40w	4100Lm	3000K	120	0+35	Empotrar	<input type="checkbox"/>	ON/OFF	684	684	60	685*685	874,44€
10383171012CVP	40w	4100Lm	3000K	120	0+35	Empotrar	<input type="checkbox"/>	1-10V	684	684	60	685*685	963,63€
10383181012CVP	40w	4100Lm	3000K	120	0+35	Empotrar	<input type="checkbox"/>	DALI	684	684	60	685*685	948,74€
10384101012CVP	40w	4100Lm	4000K	120	0+35	Empotrar	<input type="checkbox"/>	ON/OFF	684	684	60	685*685	874,44€
10384171012CVP	40w	4100Lm	4000K	120	0+35	Empotrar	<input type="checkbox"/>	1-10V	684	684	60	685*685	963,63€
10384181012CVP	40w	4100Lm	4000K	120	0+35	Empotrar	<input type="checkbox"/>	DALI	684	684	60	685*685	948,74€
10385101012CVP	40w	4100Lm	5000K	120	0+35	Empotrar	<input type="checkbox"/>	ON/OFF	684	684	60	685*685	874,44€
10385171012CVP	40w	4100Lm	5000K	120	0+35	Empotrar	<input type="checkbox"/>	1-10V	684	684	60	685*685	963,63€
10385181012CVP	40w	4100Lm	5000K	120	0+35	Empotrar	<input type="checkbox"/>	DALI	684	684	60	685*685	948,74€
10383102012CVP	40w	4100Lm	3000K	120	0+35	Empotrar	<input type="checkbox"/>	ON/OFF	1284	410	60	1265*391	923,04€
10383172012CVP	40w	4100Lm	3000K	120	0+35	Empotrar	<input type="checkbox"/>	1-10V	1284	410	60	1265*391	1012,22€
10383182012CVP	40w	4100Lm	3000K	120	0+35	Empotrar	<input type="checkbox"/>	DALI	1284	410	60	1265*391	997,33€
10384102012CVP	40w	4100Lm	4000K	120	0+35	Empotrar	<input type="checkbox"/>	ON/OFF	1284	410	60	1265*391	923,04€
10384172012CVP	40w	4100Lm	4000K	120	0+35	Empotrar	<input type="checkbox"/>	1-10V	1284	410	60	1265*391	1012,22€
10384182012CVP	40w	4100Lm	4000K	120	0+35	Empotrar	<input type="checkbox"/>	DALI	1284	410	60	1265*391	997,33€
10385102012CVP	40w	4100Lm	5000K	120	0+35	Empotrar	<input type="checkbox"/>	ON/OFF	1284	410	60	1265*391	923,04€
10385172012CVP	40w	4100Lm	5000K	120	0+35	Empotrar	<input type="checkbox"/>	1-10V	1284	410	60	1265*391	1012,22€
10385182012CVP	40w	4500Lm	5000K	120	0+35	Empotrar	<input type="checkbox"/>	DALI	1284	410	60	1265*391	997,33€
10383103012CVP	80w	8200Lm	3000K	120	0+35	Empotrar	<input type="checkbox"/>	ON/OFF	1284	684	60	1265*665	1548,30€
10383173012CVP	80w	8200Lm	3000K	120	0+35	Empotrar	<input type="checkbox"/>	1-10V	1284	684	60	1265*665	1726,67€
10383183012CVP	80w	8200Lm	3000K	120	0+35	Empotrar	<input type="checkbox"/>	DALI	1284	684	60	1265*665	1696,93€
10384103012CVP	80w	8200Lm	4000K	120	0+35	Empotrar	<input type="checkbox"/>	ON/OFF	1284	684	60	1265*665	1548,30€
10384173012CVP	80w	8200Lm	4000K	120	0+35	Empotrar	<input type="checkbox"/>	1-10V	1284	684	60	1265*665	1726,67€
10384183012CVP	80w	8200Lm	4000K	120	0+35	Empotrar	<input type="checkbox"/>	DALI	1284	684	60	1265*665	1696,93€
10385103012CVP	80w	8200Lm	5000K	120	0+35	Empotrar	<input type="checkbox"/>	ON/OFF	1284	684	60	1265*665	1548,30€
10385173012CVP	80w	8200Lm	5000K	120	0+35	Empotrar	<input type="checkbox"/>	1-10V	1284	684	60	1265*665	1726,67€
10385183012CVP	80w	8200Lm	5000K	120	0+35	Empotrar	<input type="checkbox"/>	DALI	1284	684	60	1265*665	1696,93€

ACCESORIOS **HESTER**

CÓDIGO	DESCRIPCIÓN	PVP
1038KE1H	KIT EMERGENCIA 1HORA	222,93€
1038SNS10V	SENSOR 1-10V	89,19€

LUMINARIA VACIAS PARA TUBO LED EMPTY LUMINAIRE FOR LED TUBE LUMINAIRE VIDE POUR TUBE LED

LYOPRO
LEVEL

ORAN

IP 20 | | 220-240V 50/60Hz | Chapa Acero | Alu Cover | | | CE |

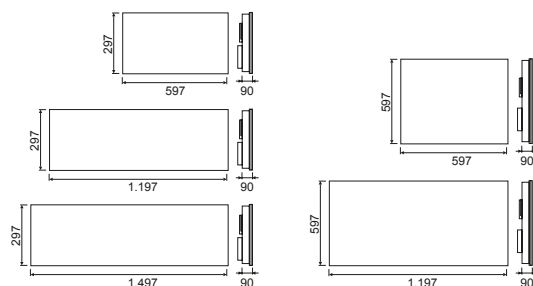
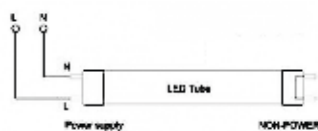
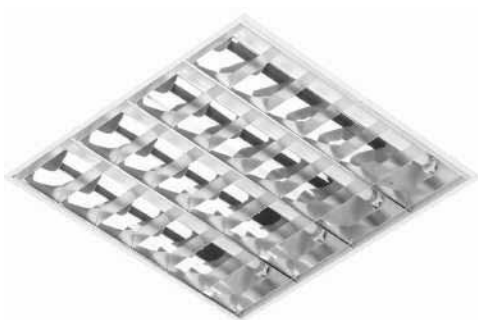

CÓDIGO	DESCRIPCIÓN	VERSIÓN			L	W	H		PVP
10386030218E	PANTALLA EMP ORAN 2X18 PARA TUBO LED	Empotrar	B <input type="checkbox"/>		297	597	90	275*575	79,79€
103812030236E	PANTALLA EMP ORAN 2X36 PARA TUBO LED	Empotrar	B <input type="checkbox"/>		297	1197	90	275*1175	94,07€
103815030258E	PANTALLA EMP ORAN 2X58 PARA TUBO LED	Empotrar	B <input type="checkbox"/>		297	1497	90	275*1475	148,31€
10386060418E	PANTALLA EMP ORAN 4X18 PARA TUBO LED	Empotrar	B <input type="checkbox"/>		597	597	90	575*575	92,64€
103812060436E	PANTALLA EMP ORAN 4X36 PARA TUBO LED	Empotrar	B <input type="checkbox"/>		597	1197	90	575*1175	165,43€

ORAN

IP 20 | | 220-240V 50/60Hz | Chapa Acero | Alu Cover | | | CE |

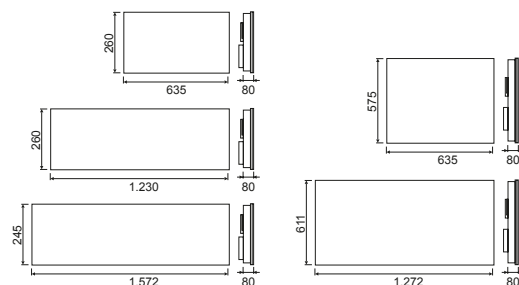
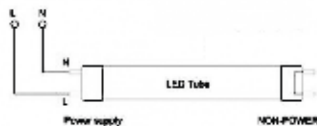

CÓDIGO	DESCRIPCIÓN	VERSIÓN			L	W	H	PVP
10386030218S	PANTALLA SUP ORAN 2X18 PARA TUBO LED	Superficie	B <input type="checkbox"/>		260	635	80	96,49€
103812030236S	PANTALLA SUP ORAN 2X36 PARA TUBO LED	Superficie	B <input type="checkbox"/>		260	1230	80	110,20€
103815030258S	PANTALLA SUP ORAN 2X58 PARA TUBO LED	Superficie	B <input type="checkbox"/>		245	1572	80	181,93€
10386060418S	PANTALLA SUP ORAN 4X18 PARA TUBO LED	Superficie	B <input type="checkbox"/>		575	635	80	119,76€
103812060436S	PANTALLA SUP ORAN 4X36 PARA TUBO LED	Superficie	B <input type="checkbox"/>		611	1272	80	196,70€





LYOPRO
LEVEL

MARCOS EMPOTRAR/SUPERFICIE
RECESSED/SURFACE FRAMES
CADRES ENCASTRÉS/SURFACE

SITARA



CÓDIGO	DESCRIPCIÓN	VERSIÓN		L	W	H		PVP
20146	Marco Empotrar Panel Led 60x60	Empotrar	B <input type="checkbox"/>	630	630	25	610*610	19,95€
20147	Marco Empotrar Panel Led 120x30	Empotrar	B <input type="checkbox"/>	1230	230	25	1210*310	24,95€
20148	Marco Empotrar Panel Led 120x60	Empotrar	B <input type="checkbox"/>	1230	630	25	1210*610	32,95€
10146	Marco Superficie Panel Led 60x60	Superficie	B <input type="checkbox"/>	605	605	48		26,95€
10147	Marco Superficie Panel Led 120x30	Superficie	B <input type="checkbox"/>	1205	305	48		27,95€
10148	Marco Superficie Panel Led 120x60	Superficie	B <input type="checkbox"/>	1205	605	48		41,95€

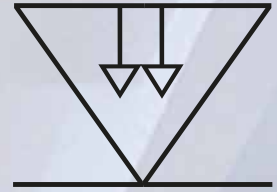

LYOPRO
LEVEL

ILUMINACIÓN PARA CENTROS DOCENTES
LIGHTING FOR EDUCATIONAL CENTERS
ÉCLAIRAGE POUR CENTRES ÉDUCATIFS

THEA

Special
R-G-O
LED CHIP

LIFUD
LED Driver

IP
20

UGR < 19



Alu

Acrylic
Cover

220-240V
50/60Hz

EM

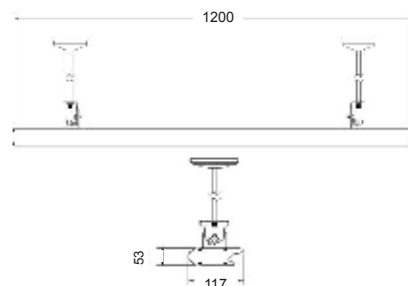

CÓDIGO	W	LM	K	ÓPTICA°	Ra/CRI	VERSIÓN			L	W	H	ELECTRÓNICA	PVP
60934	33w	3300Lm	4000K	85	>95	Suspensión	-25+40	P	1200	117	53	1-10V	322,50€

THEA

Special
R-G-O
LED CHIP

LIFUD
LED Driver

IP
20

UGR < 16



Alu

PS+ABS
Cover

220-240V
50/60Hz

EM

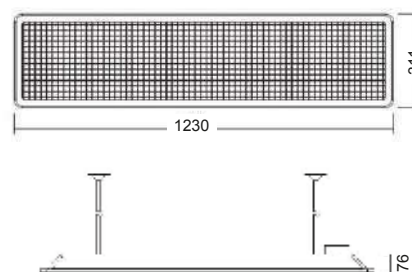

CÓDIGO	W	LM	K	ÓPTICA°	Ra/CRI	VERSIÓN			L	W	H	ELECTRÓNICA	PVP
60931	40w	3200Lm	4000K	86	>95	Suspensión	-25+40	P	1.230	311	76	1-10V	322,50€

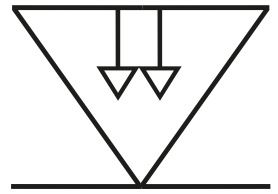

LYOPRO
LEVEL



ILUMINACIÓN INDUSTRIAL
INDUSTRIAL LIGHTING
ÉCLAIRAGE INDUSTRIEL



Available in October 23

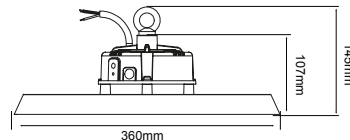
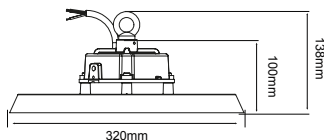
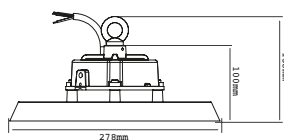
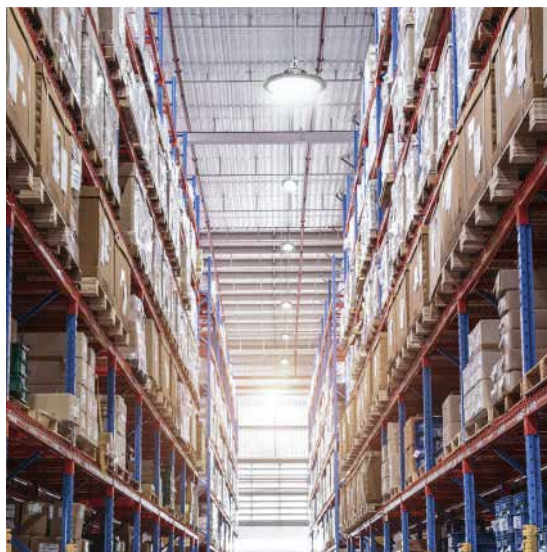

CÓDIGO	W	LM	K	ÓPTICA°		Ra/CRI		L	H	ELECTRÓNICA	PVP
64000	100w	16000Lm	4000K	60	N	>80	-30+45	278	100	1-10V	138,95€
64003	100w	16000Lm	4000K	90	N	>80	-30+45	278	100	1-10V	138,95€
64006	100w	16000Lm	4000K	120	N	>80	-30+45	278	100	1-10V	138,95€
64001	150w	24000Lm	4000K	60	N	>80	-30+45	320	100	1-10V	159,95€
64004	150w	24000Lm	4000K	90	N	>80	-30+45	320	100	1-10V	159,95€
64007	150w	24000Lm	4000K	120	N	>80	-30+45	320	100	1-10V	159,95€
64002	200w	32000Lm	4000K	60	N	>80	-30+45	360	107	1-10V	184,96€
64005	200w	32000Lm	4000K	90	N	>80	-30+45	360	107	1-10V	184,96€
64008	200w	32000Lm	4000K	120	N	>80	-30+45	360	107	1-10V	184,96€

ACCESORIOS ANUBIS

REFLECTOR ANUBIS 100W
CÓDIGO: 64020
PVP: 36,95€



REFLECTOR ANUBIS 150W
CÓDIGO: 64021
PVP: 37,95€



REFLECTOR ANUBIS 200W
CÓDIGO: 64022
PVP: 49,95€



LIRA ANUBIS 100W
CÓDIGO: 64023
PVP: 17,95€



LIRA ANUBIS 150W
CÓDIGO: 64024
PVP: 21,95€



LIRA ANUBIS 200W
CÓDIGO: 64025
PVP: 24,95€



OREL



CÓDIGO	W	LM	K	ÓPTICA°		Ra/CRI			L	H	ELECTRÓNICA	PVP
60971	150w	18000Lm	4000K	110	B	>80	-40+55		384	50	1-10V	290,25€

ACCESORIOS OREL

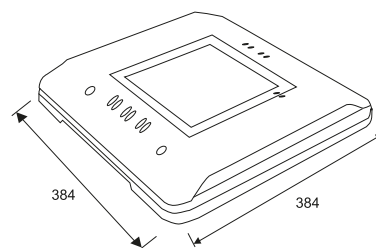

POSTE DE MONTAJE
PARA SUSPENSIÓN
CÓDIGO: 60973
PVP: 79,80€



CAJA DE MONTAJE
CÓDIGO: 60974
PVP: 59,05€



PLACA DE MONTAJE
CÓDIGO: 60975
PVP: 59,05€



PROTECTOR PC TRASLUCIDO
CÓDIGO: 60976
PVP: 17,75€





LYOPRO
LEVEL

LUMINARIAS ESTANCAS
WATERPROOF LUMINAIRES
LUMINAIRES ÉTANCHES

BELA

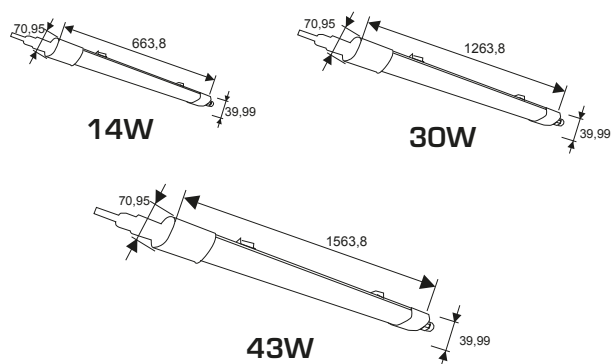

CÓDIGO	W	LM	K	ÓPTICA°	Ra/CRI	°C		L	W	H	ELECTRÓNICA	PVP
60981	14w	1820Lm	4000K	120	>90	-20+40	B <input type="checkbox"/>	663,8	70,95	39,99	ON/OFF	59,95€
60984	30w	3900Lm	4000K	120	>90	-20+40	B <input type="checkbox"/>	1263,8	70,95	39,99	ON/OFF	79,95€
60987	43w	5590Lm	4000K	120	>90	-20+40	B <input type="checkbox"/>	1563,8	70,95	39,99	ON/OFF	99,95€

ACCESORIOS BELA

KIT SUSPENSIÓN 1,5MX2

CÓDIGO: 60989

PVP: 11,75€



CABLE CONEXIÓN 0,5M MACHO/HEMBRA

CÓDIGO: 60990

PVP: 8,90€



CABLE CONEXIÓN 1M MACHO/HEMBRA

CÓDIGO: 60991

PVP: 11,75€



CABLE CONEXIÓN 2M MACHO/HEMBRA

CÓDIGO: 60992

PVP: 15,40€



LYRA

IP 66 ⚡ IK 08 □ 200-240V 50/60Hz PC ANTI UV PC ANTI UV Cover Cri>80 ⌞ 🏠 ☑ ☑ CE 5

New

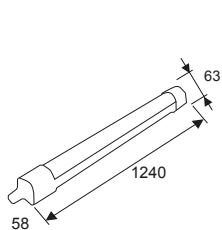

19-30W

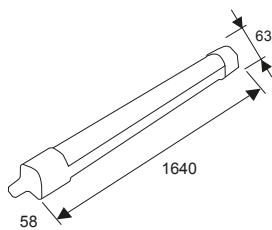

33-47W

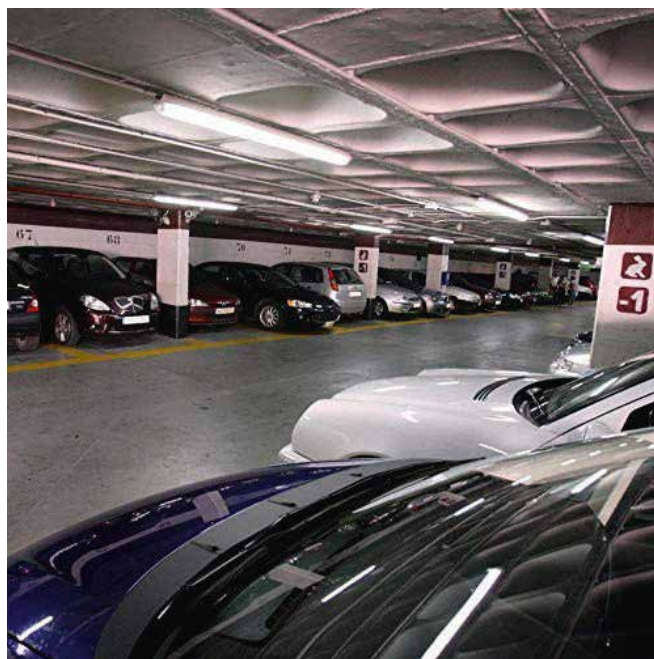

CÓDIGO	W	LM	K	ÓPTICA°	🌡️	🎨	📏			ELECTRÓNICA	PVP
							L	W	H		
63300	19-30w	2500-3900Lm	4000K	120	-20+35	B <input type="checkbox"/>	1240	58	63	ON/OFF	89,95€
63301	33-47w	4300-6100Lm	4000K	120	-20+35	B <input type="checkbox"/>	1640	58	63	ON/OFF	99,95€

HELIO

IP 66 ⚡ IK 08 □ 200-240V 50/60Hz PC ANTI UV PC ANTI UV Cover Cri>80 ⌞ 🏠 ☑ ☑ CE 5

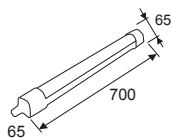

20W

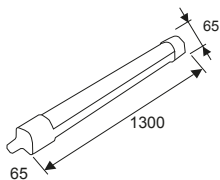

36W

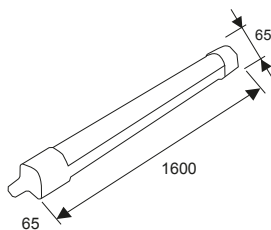

50W

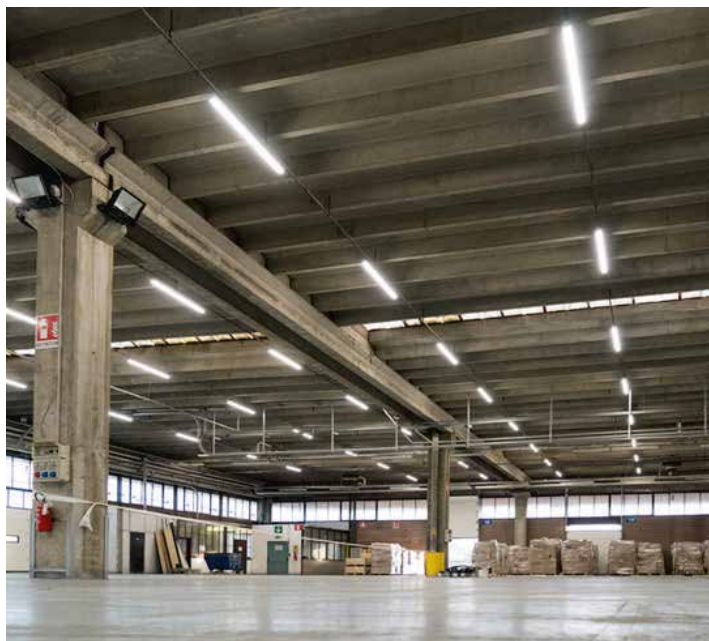

CÓDIGO	W	LM	K	ÓPTICA°	VERSIÓN	🌡️	🎨	📏			ELECTRÓNICA	PVP
								L	W	H		
1038601CP	20w	2200Lm	4000K	120	Suspensión	-10+35	B <input type="checkbox"/>	700	65	65	ON/OFF	80,56€
1038211CP	36w	4200Lm	4000K	120	Suspensión	-10+35	B <input type="checkbox"/>	1300	65	65	ON/OFF	94,06€
1038511CP	50w	5800Lm	4000K	120	Suspensión	-10+35	B <input type="checkbox"/>	1600	65	65	ON/OFF	115,50€

LUMINARIAS ATEX



LYOPRO
LEVEL

LUMINARIA ESTANCA ATEX



IP
67



CE

2

Crouse-Hinds
by **F.T.N**

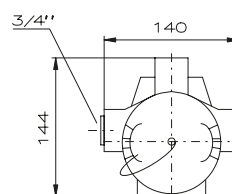

* Lámpara no incluida

CÓDIGO	TIPO LÁMPARA	MATERIAL		Ra/CRI				ZONAS	PVP
					L	W	H		
62180	2xG13 T8 led	Borosilicato	-20+40	>80	707	140	144	1,2,21,22	A consultar
62181	2xG13 T8 led	Borosilicato	-20+40	>80	1265	140	144	1,2,21,22	
62182	2xG13 T8 led	Borosilicato	-20+40	>80	1565	140	144	1,2,21,22	

EMERGENCIA ATEX



IP
67



CE

2

Crouse-Hinds
by **F.T.N**

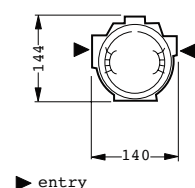
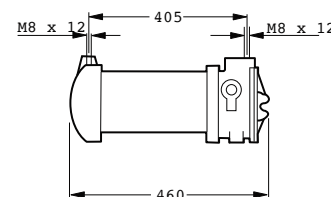

* Lámpara no incluida

CÓDIGO	TIPO LÁMPARA	LM	MATERIAL	Ra/CRI				ZONAS	PVP
					L	W	H		
62183	Led 5,5w	360Lm	Borosilicato	>80	460	140	144	1,2,21,22	A consultar

ACCESORIOS ATEX



CÓDIGO	DESCRIPCIÓN PRENSAESTOPAS Ex-d ADE 4F	PVP
62184	Tipo 6 - 3/4", rango de sujeción 10-16 mm, longitud de rosca 16 mm, temp. -60° C hasta +140° C, latón niquelado	A consultar
62185	Tipo 7 - 3/4", rango de sujeción 13.5 - 21 mm, longitud de rosca 16 mm, temp. -60° C hasta +140° C, latón niquelado	
62186	Tipo 6 - M20, rango de sujeción 10-16 mm, longitud de rosca 15 mm, temp. -60° C hasta +140° C, latón niquelado	
62187	Tipo 7 - M20, rango de sujeción 13.5 - 21 mm, longitud de rosca 15 mm, temp. -60° C hasta +140° C, latón niquelado	



LYOPRO

ELEVEL



ILUMINACIÓN DEPORTIVA Y GRANDES ÁREAS
SPORTS LIGHTING AND LARGE AREAS
ÉCLAIRAGE SPORTIF ET GRANDES SURFACES



400W - 500 - 600W

800W - 1.000 - 1.200W

1.600W - 2.000 - 2.400W

CÓDIGO	W	LM	K		Ra/CRI		ÓPTICA°				ELECTRÓNICA	PVP
								L	W	H		
61840	400w	56000Lm	4000K	P	>80	-30+50	<u>15</u>	480,6	545,66	338,63	1-10V	
61841	500w	70000Lm	4000K	P	>80	-30+50	<u>30</u>	480,6	545,66	338,63	1-10V	
61842	600w	84000Lm	4000K	P	>80	-30+50	<u>60</u>	480,6	545,66	338,63	1-10V	
61843	800w	112000Lm	4000K	P	>80	-30+50	<u>90</u>	891,1	549,01	338,63	1-10V	
61844	1000w	140000Lm	4000K	P	>80	-30+50	<u>120</u>	891,1	549,01	338,63	1-10V	
61845	1200w	168000Lm	4000K	P	>80	-30+50		891,1	549,01	338,63	1-10V	
61846	1600w	224000Lm	4000K	P	>80	-30+50		977	522,5	600	1-10V	
61847	2000w	280000Lm	4000K	P	>80	-30+50		977	522,5	600	1-10V	
61848	2400w	336000Lm	4000K	P	>80	-30+50		977	522,5	600	1-10V	

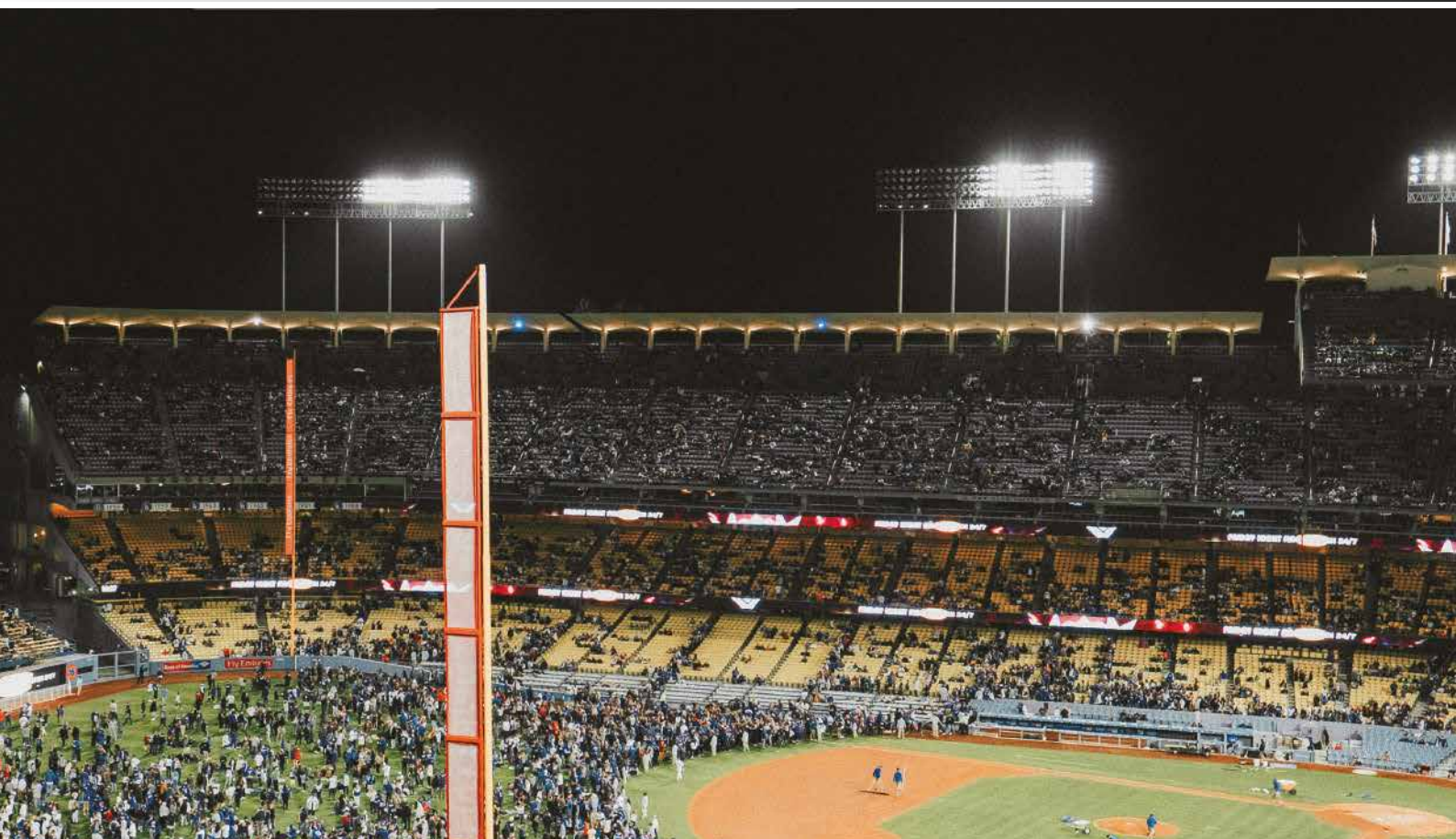



Bajo Proyecto

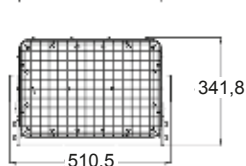
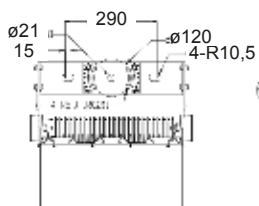
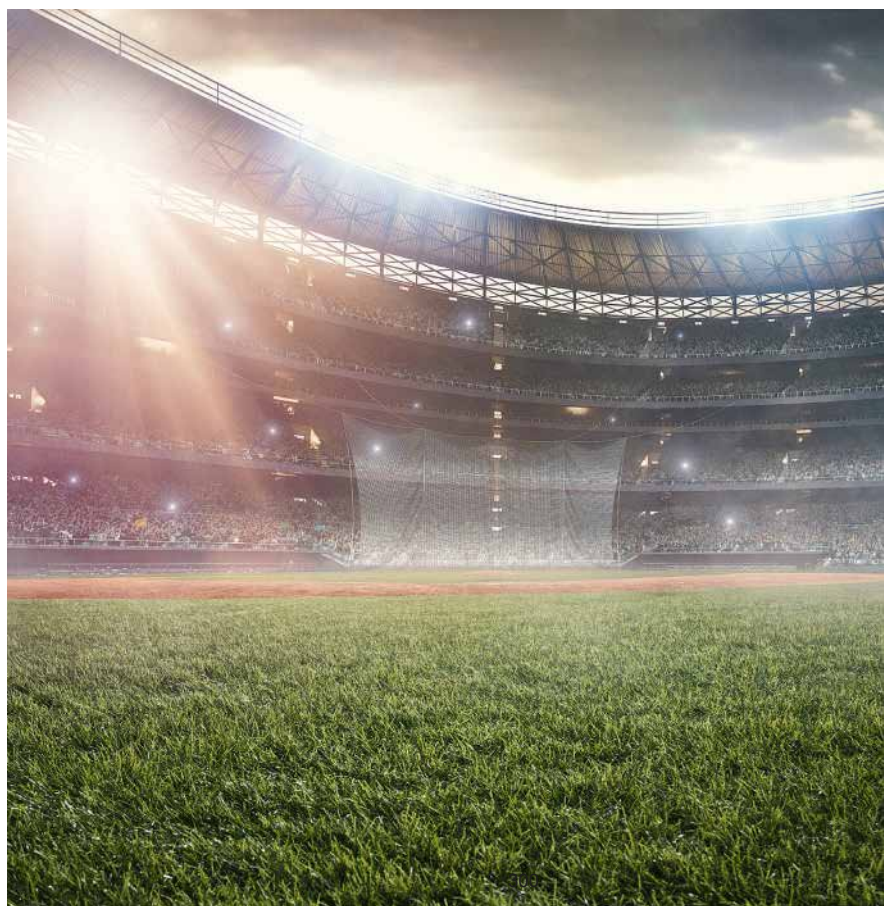

400W - 500W - 600W

H

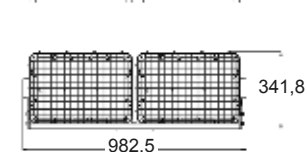
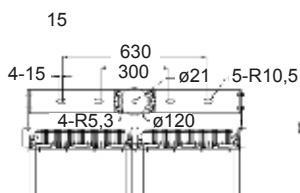

800W - 1.000W - 1.200W

H

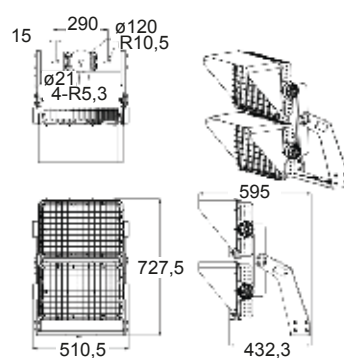

800W - 1.000W - 1.200W

V

CÓDIGO	W	LM	K		Ra/CRI	VERSIÓN	ÓPTICA°	L	W	H	ELECTRÓNICA	PVP
64200	400w	60000Lm	4000K	N	>80	H	<u>25</u>	510,5	459,9	341,8	<u>SR</u>	ON/OFF
64201	500w	75000Lm	4000K	N	>80	H	<u>40</u>	510,5	459,9	341,8	<u>A</u>	TRIAC
64202	600w	90000Lm	4000K	N	>80	H		510,5	459,9	341,8	<u>B</u>	1-10V
64203	800w	120000Lm	4000K	N	>80	H		982,5	459,9	341,8	<u>C</u>	PUSH/DALI
64204	1000w	120000Lm	4000K	N	>80	H		982,5	459,9	341,8		
64205	1200w	150000Lm	4000K	N	>80	H		982,5	459,9	341,8		
64206	800w	150000Lm	4000K	N	>80	V		510,5	595	727,5		
64207	1000w	180000Lm	4000K	N	>80	V		510,5	595	727,5		
64208	1200w	180000Lm	4000K	N	>80	V		510,5	595	727,5		



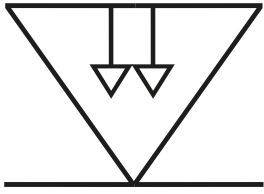

LYOPRO
LEVEL



IP66

GOLDEN

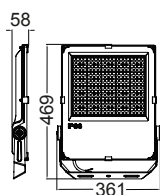

200W

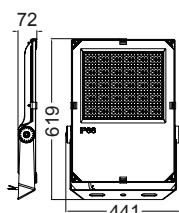

300-400W

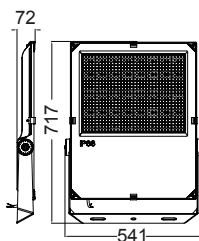

500W



Bracket Design

Bending brackets can be quickly installed using tools, saving installation time and cost.



Eye-bolt



Adjustable bracke

CÓDIGO	W	LM	K	ÓPTICA°	Ra/CRI	☁	🎨	🏠			ELECTRÓNICA	PVP
								L	W	H		
64049	200w	30000Lm	4000K	120	>80	-30+45	N	361	58	469	1-10V	284,95€
64070	200w	30000Lm	4000K	135x60	>80	-30+45	N	361	58	469	1-10V	284,95€
64052	300w	45000Lm	4000K	120	>80	-30+45	N	441	72	619	1-10V	455,95€
64073	300w	45000Lm	4000K	135x60	>80	-30+45	N	441	72	619	1-10V	455,95€
64055	400w	56000Lm	4000K	120	>80	-30+45	N	441	72	619	1-10V	599,95€
64076	400w	56000Lm	4000K	135x60	>80	-30+45	N	441	72	619	1-10V	599,95€
64058	500w	75000Lm	4000K	120	>80	-30+45	N	541	72	717	1-10V	789,95€
64079	500w	75000Lm	4000K	135x60	>80	-30+45	N	541	72	717	1-10V	789,95€



LYOPRO
LEVEL

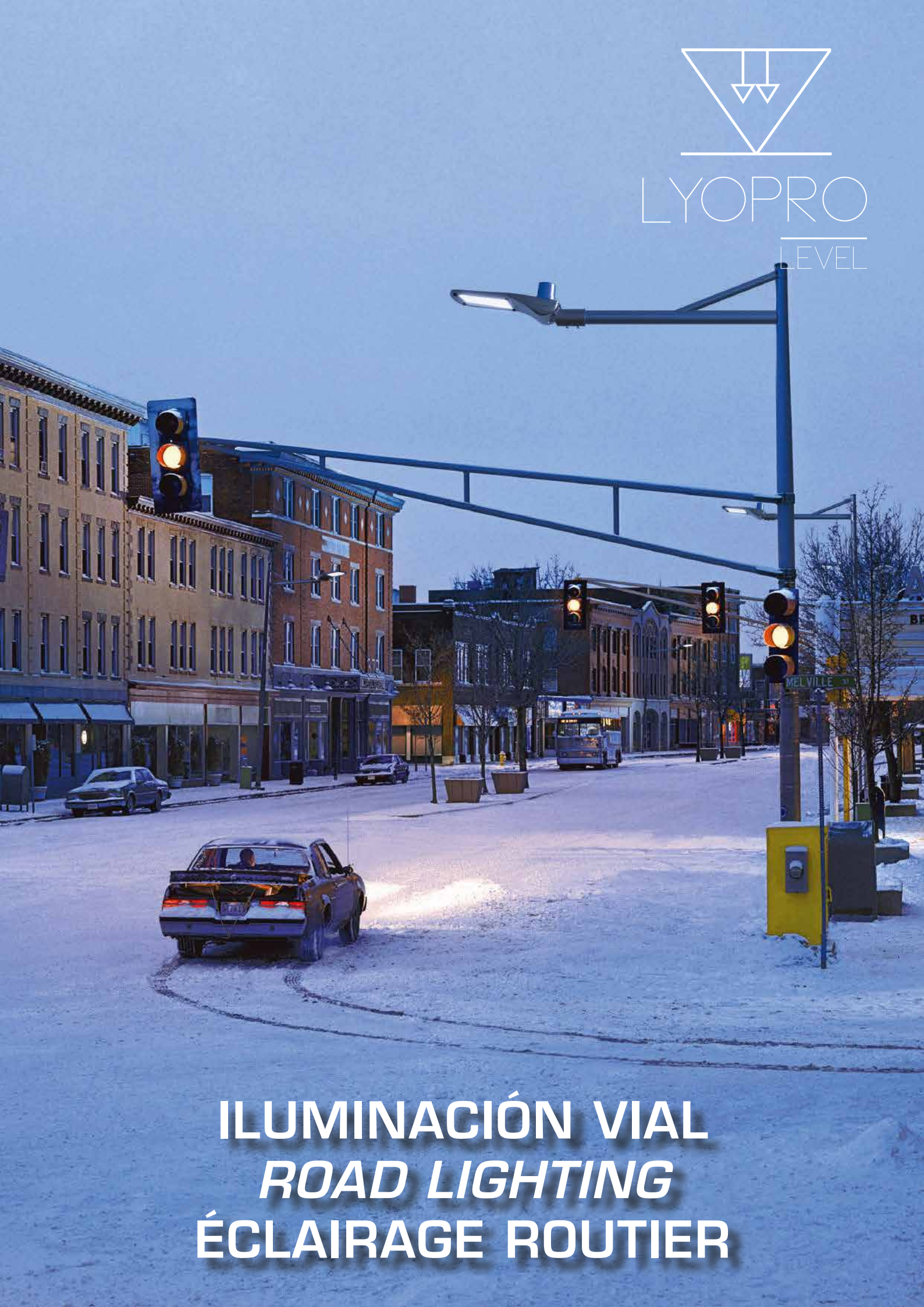

ILUMINACIÓN VIAL
ROAD LIGHTING
ÉCLAIRAGE ROUTIER

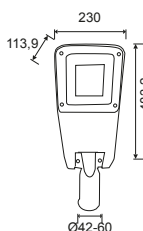

60W

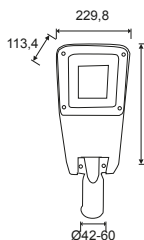

100W

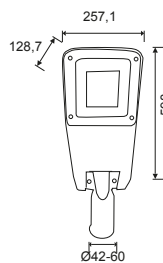

150W

CÓDIGO	W	LM	K	ÓPTICA°	Ra/CRI			L	W	H	ELECTRÓNICA	PVP
61804	60w	7800Lm	4000K	150x104	>80	-30+45	GT	483,2	230	113,9	1-10V	319,24€
61807	60w	7800Lm	4000K	155x108	>80	-30+45	GT	483,2	230	113,9	1-10V	319,24€
61810	60w	7800Lm	4000K	145x110	>80	-30+45	GT	483,2	230	113,9	1-10V	319,24€
61805	100w	13000Lm	4000K	150x104	>80	-30+45	GT	548,2	229,8	113,4	1-10V	413,86€
61808	100w	13000Lm	4000K	155x108	>80	-30+45	GT	548,2	229,8	113,4	1-10V	413,86€
61811	100w	13000Lm	4000K	145x110	>80	-30+45	GT	548,2	229,8	113,4	1-10V	413,86€
61806	150w	19500Lm	4000K	150x104	>80	-30+45	GT	598	257,1	128,7	1-10V	473,00€
61809	150w	19500Lm	4000K	155x108	>80	-30+45	GT	598	257,1	128,7	1-10V	473,00€
61812	150w	19500Lm	4000K	145x110	>80	-30+45	GT	598	257,1	128,7	1-10V	473,00€

ACCESORIOS ALEX

Fotocelula AC100-277V

CÓDIGO: 61823

PVP: 24,19€



Base para Fococelula

CÓDIGO: 61824

PVP: 8,06€



Cortocircuitos

CÓDIGO: 61825

PVP: 16,02€





CÓDIGO	W	LM	K	ÓPTICA°	Ra/CRI	-/+	L	W	H	ELECTRÓNICA	PVP	
61930	30w	3900Lm	4000K	<u>2</u> Type II	A	>80	-40+50	490	689	109	<u>SR</u> ON/OFF	A consultar
61931	40w	5200Lm	4000K	<u>3</u> Type III medium	A	>80	-40+50	490	689	109	<u>A</u> PUSH	
61932	60w	7800Lm	4000K		A	>80	-40+50	490	689	109	<u>B</u> 1-10V	
61933	100w	13000Lm	4000K		A	>80	-40+50	490	689	109	<u>C</u> DALI	
61934	150w	19500Lm	4000K		A	>80	-40+50	490	689	109		

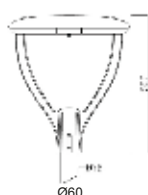

CÓDIGO	W	LM	K	ÓPTICA°	Ra/CRI	-/+	L	W	H	ELECTRÓNICA	PVP	
62140	30w	3900Lm	4000K	<u>2</u> Type II	A	>80	-20+60	490	490	558	<u>SR</u> ON/OFF	A consultar
62141	40w	5200Lm	4000K	<u>3</u> Type III medium	A	>80	-20+60	490	490	558	<u>A</u> PUSH	
62142	60w	7800Lm	4000K		A	>80	-20+60	490	490	558	<u>B</u> 1-10V	
62143	100w	13000Lm	4000K		A	>80	-20+60	490	490	558	<u>C</u> DALI	
62144	150w	19500Lm	4000K		A	>80	-20+60	490	490	558		

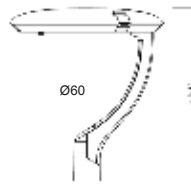

CÓDIGO	W	LM	K	ÓPTICA°	Ra/CRI	Ra	L	W	H	ELECTRÓNICA	PVP	
62120	30w	3900Lm	4000K	<u>2</u> Type II	A	>80	-20+60	490	490	558	<u>SR</u> ON/OFF	A consultar
62121	40w	5200Lm	4000K	<u>3</u> Type III medium	A	>80	-20+60	490	490	558	<u>A</u> PUSH	
62122	60w	7800Lm	4000K		A	>80	-20+60	490	490	558	<u>B</u> 1-10V	
62123	100w	13000Lm	4000K		A	>80	-20+60	490	490	558	<u>C</u> DALI	
62124	150w	19500Lm	4000K		A	>80	-20+60	490	490	558		

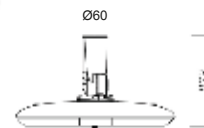

CÓDIGO	W	LM	K	ÓPTICA°	Ra/CRI	Ra	L	W	H	ELECTRÓNICA	PVP	
61950	30w	3900Lm	4000K	<u>2</u> Type II	A	>80	-20+60	490	689	109	<u>SR</u> ON/OFF	A consultar
61951	40w	5200Lm	4000K	<u>3</u> Type III medium	A	>80	-20+60	490	689	109	<u>A</u> PUSH	
61952	60w	7800Lm	4000K		A	>80	-20+60	490	689	109	<u>B</u> 1-10V	
61953	100w	13000Lm	4000K		A	>80	-20+60	490	689	109	<u>C</u> DALI	
61954	150w	19500Lm	4000K		A	>80	-20+60	490	689	109		

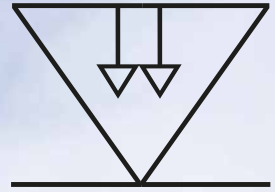

LYOPRO
LEVEL

TORRES, COLUMNAS Y CRUCETAS
TOWERS, COLUMNS AND CROSSES
TOURS, COLONNES ET CROIX

COLUMNA MODELO EUROPEO

PVP

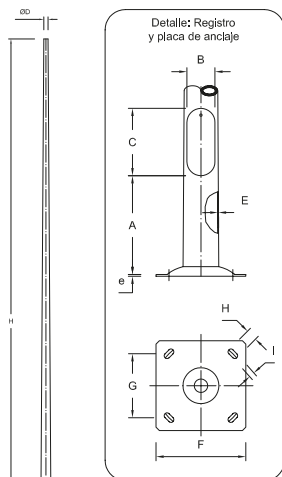

REFERENCIA	H(m)	D(mm)	E(mm)	Pernos	A(mm)	B(mm)	C(mm)	e(mm)	F(mm)	G(mm)	H(mm)	I(mm)
62601	4	76	3	M14X400	410	80	220	6	300	215	45	20
62602	5	60	3	M16X500								
62604	6	60	3	M16X500	440	125	300	8	400	285	50	25
62606	7	60	3	M18X500								
62607	7	76	3	M18X500								
62608	8	60	3	M18X500								
62610	8	76	4	M18X500								
62611	9	60	3	M18X500								
62613	9	76	4	M18X500								
62614	10	60	3	M20X700								
62616	10	76	4	M20X700								
62617	12	60	4	M22X700	10	300	8	400	285	50	25	
62618	12	76	4	M22X700								
62620	14	76	4	M24X700	12	300	8	400	285	50	25	

COLUMNA MODELO AM-10

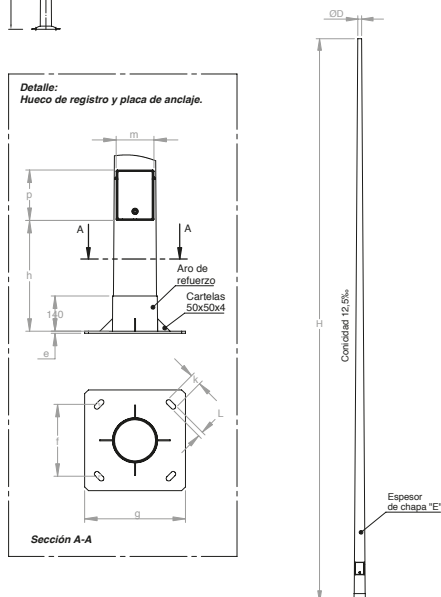

REFERENCIA	DIMENSIONES PRINCIPALES			Placa de anclaje				Hueco registro			Pernos	
	H(m)	D	E	e	f	g	k	L	h	p		m
62621	4	76	3	6	215	300	45	20	410	170	110	M14X400
62622	5	60	3	6	215	300	45	20	410	170	110	M16X500
62624	6	60	3	6	215	300	45	20	410	170	110	M16X500
62626	7	60	3	8	285	400	50	25	440	170	110	M18X500
62627		76	4	8	285	400	50	25	440	170	110	
62628	8	60	3	8	285	400	50	25	440	170	110	M18X500
62630		76	4	8	285	400	50	25	440	200	150	
62631	9	60	3	8	285	400	50	25	440	200	150	M18X500
62633		76	4	8	285	400	50	25	440	200	150	
62635	10	60	3	10	285	400	50	25	440	200	150	M20X700
62636		76	4	10	285	400	50	25	440	200	150	
62637	12	60	4	10	285	400	50	25	440	200	150	M22X700
62638		76	4	10	285	400	50	25	440	200	150	
62640	14	76	4	10	285	400	50	25	440	200	150	M24X700

CÓDIGO CRUCETA COLUMNA ÁNGULO PARA PROYECTORES A PUNTA COLUMNA

- 62550 Cruceta en ángulo para 1 proyector punta 60/76 GALVANIZADA
- 62551 Cruceta en ángulo para 2/3 proyector punta 60/76 GALVANIZADA
- 62552 Cruceta reforzada en ángulo para 4 proyectores punta 76 GALVANIZADA
- 62553 Cruceta reforzada en ángulo para 6 proyectores punta 76 GALVANIZADA



CRUCETA COLUMNA ÁNGULO PARA PROYECTORES CON ABRAZADERAS

- 62554 Cruceta en ángulo para 1 proyector abrazadera GALVANIZADA
- 62555 Cruceta en ángulo para 2 proyectores abrazadera GALVANIZADA
- 62556 Cruceta en ángulo para 3 proyectores abrazadera GALVANIZADA
- 62557 Cruceta en ángulo para 4 proyectores abrazadera GALVANIZADA



CRUCETA COLUMNA FORMATO CORONA EN PUNTA

- 62558 Cruceta columna formato corona circular en punta para 4 proyectores
- 62559 Cruceta columna formato corona circular en punta para 5 proyectores
- 62560 Cruceta columna formato corona hexagonal en punta para 6 proyectores
- 62561 Cruceta columna formato corona octogonal en punta para 8 proyectores



CRUCETA COLUMNA PARA LUMINARIA

- 62562 Cruceta columna 1 lum. Columna ø 60. Lum. ø 60. Brazo 500. Galva Caliente
- 62563 Cruceta columna 1 lum. Columna ø 60. Lum. ø 60. Brazo 1000. Galva Caliente
- 62564 Cruceta columna 1 lum. Columna ø 60. Lum. ø 60. Brazo 1500. Galva Caliente
- 62565 Cruceta columna 2 lum. Columna ø 60. Lum. ø 60. Brazo 500. Galva Caliente
- 62566 Cruceta columna 2 lum. Columna ø 60. Lum. ø 60. Brazo 1000. Galva Caliente
- 62567 Cruceta columna 2 lum. Columna ø 60. Lum. ø 60. Brazo 1500. Galva Caliente
- 62568 Cruceta columna 3 lum. Columna ø 60. Lum. ø 60. Brazo 500. Galva Caliente
- 62569 Cruceta columna 3 lum. Columna ø 60. Lum. ø 60. Brazo 1000. Galva Caliente
- 62570 Cruceta columna 3 lum. Columna ø 60. Lum. ø 60. Brazo 1500. Galva Caliente
- 62571 Cruceta columna 4 lum. Columna ø 60. Lum. ø 60. Brazo 500. Galva Caliente
- 62572 Cruceta columna 4 lum. Columna ø 60. Lum. ø 60. Brazo 1000. Galva Caliente
- 62573 Cruceta columna 4 lum. Columna ø 60. Lum. ø 60. Brazo 1500. Galva Caliente



- 62574
- 62575
- 62576
- 62577
- 62578

BRAZO MURAL PARA PROYECTOR

- 62574 Brazo mural para proyector de 500mm pintado en negro
- 62575 Brazo mural para proyector de 600mm pintado en negro
- 62576 Brazo mural para proyector de 750mm pintado en negro
- 62577 Brazo mural para proyector de 1000mm pintado en negro
- 62578 Brazo mural para proyector de 1500mm pintado en negro

BRAZO MURAL PARA LUMINARIA

- 62579
- 62580
- 62581
- 62582

- 62579 Brazo mural para luminaria ø60 de 500mm
- 62580 Brazo mural para luminaria ø60 de 1000mm
- 62581 Brazo mural para luminaria ø60 de 1500mm
- 62582 Brazo mural para luminaria ø60 de 2000mm

PERNOS CON 2 TUERCAS Y 2 ARANDELAS

- 62583
- 62584
- 62585
- 62586
- 62587
- 62588
- 62589
- 62590
- 62591
- 62592
- 62593
- 62594
- 62595
- 62596

- M14X400 CINCADO
- M16X500 CINCADO
- M16X500 CINCADO
- M18X500 CINCADO
- M18X600 CINCADO
- M20X500 CINCADO
- M20X700 CINCADO
- M20X1000 CINCADO
- M22X500 CINCADO
- M22X700 CINCADO
- M22X71000 CINCADO
- M24X700 CINCADO
- M24X1000 CINCADO
- M24X1500

OPCIONES

- 62597
- 62598
- 62599
- 62600

- 62597 Plantilla columna distintas medidas
- 62598 Placa adaptada. Distinta distancia
- 62599 Base abatible para columna
- 62600 Apoyos troncopiramidales abatibles a media altura



LYOPRO
LEVEL

ILUMINACIÓN DE EXTERIOR EMPOTRAR
OUTDOOR RECESSED LIGHTING
ÉCLAIRAGE ENCASTRÉ EXTÉRIEUR

URI

bridgelux
LED CHIP

IP
65



IK
08

100-265V
50/60Hz

Alu

Inox
304

Glass
Trans

20 CM.



2000Kg



CE

3

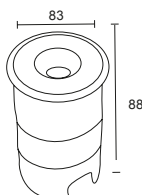

Realizar siempre correcta línea. 333 mm.l

CÓDIGO	W	LM	K	VERSIÓN	ÓPTICA°	Ra/CRI			L	H		PVP
61001	7w	700Lm	4000K	Redondo asimetrico	60	>80	-20+50	INOX	88	83	78	45,70€

SHERA

bridgelux
LED CHIP

IP
65



IK
08

100-265V
50/60Hz

Alu

Inox
304

Glass
Trans

20 CM.



2000Kg



CE

3



Realizar siempre correcta línea. 333 mm.l

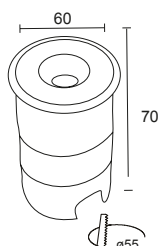
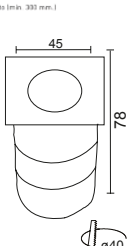
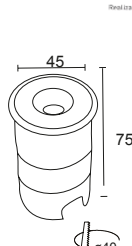

CÓDIGO	W	LM	K	VERSIÓN	ÓPTICA°	Ra/CRI			L	H		PVP
61007	3w	300Lm	4000K	Redondo	30	>80	-20+50	INOX	45	75	40	34,20€
61010	3w	300Lm	4000K	Cuadrado	30	>80	-20+50	INOX	45	78	40	34,20€
61004	5w	500Lm	4000K	Redondo	30	>80	-20+50	INOX	60	70	55	45,70€

INHAR

bridgelux
LED CHIP

IP
65



IK
08

100-265V
50/60Hz

Alu

Inox
304

Glass
Trans

20 CM.



2000Kg



CE

3

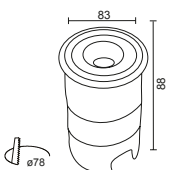

Realizar siempre correcta línea. 333 mm.l

CÓDIGO	W	LM	K	VERSIÓN	ÓPTICA°	Ra/CRI			L	H		PVP
61013	5w	500Lm	4000K	Redondo	30	>80	-20+50	INOX	88	83	78	57,15€

GULARA

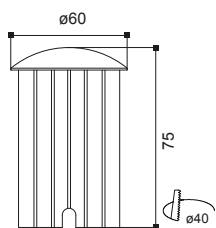

Realizar siempre conexión (mín. 333 mm.)

CÓDIGO	W	LM	K	VERSIÓN	ÓPTICA°	Ra/CRI	°C	Color	L	H	Icon	PVP
61016	3w	300Lm	4000K	Redondo 1 salida	60	>80	-20+50	INOX	60	75	40	45,70€
61019	3w	300Lm	4000K	Redondo 2 salidas	60	>80	-20+50	INOX	60	75	40	45,70€
61022	3w	300Lm	4000K	Redondo 3 salidas	60	>80	-20+50	INOX	60	75	40	45,70€
61025	3w	300Lm	4000K	Redondo 4 salidas	60	>80	-20+50	INOX	60	75	40	45,70€

SEREN

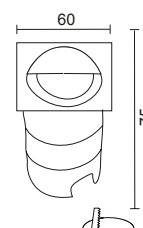
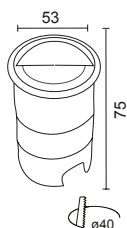

CÓDIGO	W	LM	K	VERSIÓN	ÓPTICA°	Ra/CRI	°C	Color	L	H	Icon	PVP
61028	3w	300Lm	4000K	Redondo	60	>80	-20+60	B	53	75	40	40,05€
61031	3w	300Lm	4000K	Cuadrado	60	>80	-20+60	B	60	75	40	40,05€

ADRIA

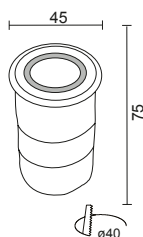

CÓDIGO	W	LM	K	VERSIÓN	ÓPTICA°	Ra/CRI	°C	Color	L	H	Icon	PVP
61034	3w	300Lm	4000K	Redondo	180	>80	-20+60	B	45	75	40	34,30€

MARIA

bridgelux
LED CHIP

IP 65



IK 07

100-265V
50/60Hz

Alu

Glass
Cover

20 CM.



CE

3

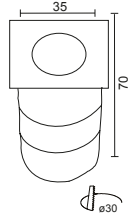
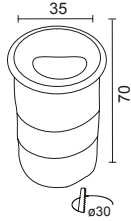
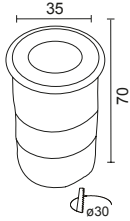
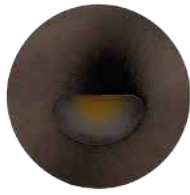

Realizar empuje correcto (mín. 300 mm.)

CÓDIGO	W	LM	K	VERSIÓN	ÓPTICA°	Ra/CRI				L	H		PVP
61037	3w	300Lm	4000K	Redondo	120	>80	-20+60	ACP		35	70	30	34,30€
61040	3w	300Lm	4000K	Cuadrado	120	>80	-20+60	ACP		35	70	30	34,30€
61043	3w	300Lm	4000K	Redondo asimétrico	60	>80	-20+60	ACP		35	70	30	34,30€

PILEA

EPSTAR
LED CHIP

IP 67



IK 10

Alu

Inox 316

Glass
Frosted

50 CM.



CE

3

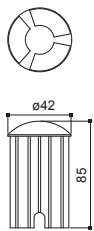
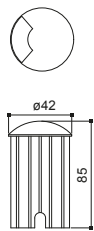
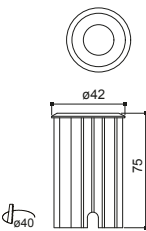

Realizar empuje correcto (mín. 300 mm.)



Available in November 23
24V

CÓDIGO	W	LM	K	VERSIÓN	ÓPTICA°	VOLTAJE				L	H		PVP
61053	1w	85Lm	3000K	Redondo	30	220V	-20+50	INOX		42	75	40	68,55€
61054	1w	90Lm	4000K	Redondo	30	220V	-20+50	INOX		42	75	40	68,55€
61048	1w	85Lm	3000K	Redondo	30	24V	-20+50	INOX		42	75	40	59,55€
61049	1w	90Lm	4000K	Redondo	30	24V	-20+50	INOX		42	75	40	59,55€
61056	1w	85Lm	3000K	Redondo 1 salida	70	220V	-20+50	INOX		42	85	40	91,35€
61057	1w	90Lm	4000K	Redondo 1 salida	70	220V	-20+50	INOX		42	85	40	91,35€
61059	1w	85Lm	3000K	Redondo 2 salidas	70	220V	-20+50	INOX		42	85	40	98,35€
61060	1w	90Lm	4000K	Redondo 2 salidas	70	220V	-20+50	INOX		42	85	40	98,35€

New

Available in November 23

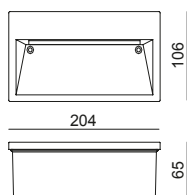
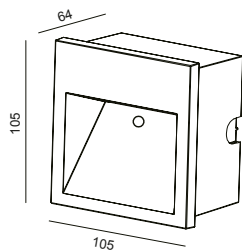

CÓDIGO	W	LM	K	ÓPTICA°	Ra/CRI	-	+	A	L	W	H	96x96	PVP
61480	3w	150Lm	3000K	120	>80	-20	+50	A	105	105	64	96x96	44,95€
61481	3w	180Lm	4000K	120	>80	-20	+50	A	105	105	64	96x96	44,95€
61483	9w	450Lm	3000K	120	>80	-20	+50	A	106	204	65	196x96	74,95€
61484	9w	520Lm	4000K	120	>80	-20	+50	A	106	204	65	196x96	74,95€



COOPER

OSRAM
LED CHIP

IP
65



IK
07

220-240V
50/60Hz

Alu

Glass
Tempered

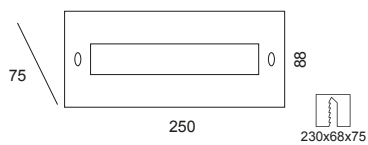

CÓDIGO	W	LM	K	ÓPTICA°	Ra/CRI	TEMP	PALETTE	L	W	H	DET	PVP
61071	8w	220Lm	3000K	42	>80	-20+50	A	250	88	75	230*68*75	146,20€
61072	8w	220Lm	4000K	42	>80	-20+50	A	250	88	75	230*68*75	146,20€

VERA

bridgelux
LED CHIP

IP
67



IK
08

100-240V
50/60Hz

Alu

Inox
316

Glass
Frosted

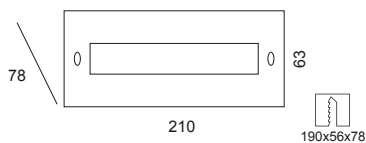

CÓDIGO	W	LM	K	ÓPTICA°	Ra/CRI	TEMP	PALETTE	L	W	H	DET	PVP
61045	6w	570Lm	3000K	120	>80	-30+60	INOX	210	63	78	190*56*78	249,95€
61046	6w	600Lm	4000K	120	>80	-30+60	INOX	210	63	78	190*56*78	249,95€

CIANA

IP 67 | IK 10 | Alu | Inox 316 | Glass Frosted | 50 CM. | 2500Kg | | | | CE |

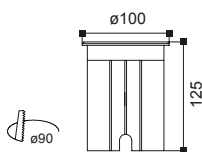
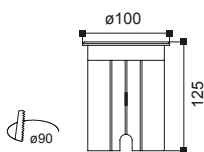

Realizar siempre correcta (mín. 300 mm.)



CÓDIGO	TIPO LÁMPARA	VERSIÓN				L	H		PVP
61051	GU-10	Redondo	-20+50	INOX		100	125	90	54,80€
61052	GU-10	Cuadrado	-20+50	INOX		100	125	90	58,00€

HATRIA

EPISTAR LED CHIP

IP 67 | | | IK 09 | 220-240V 50/60Hz | Alu | Inox 316 | Glass Tempered | 50 CM. | 2000Kg | | | CE |

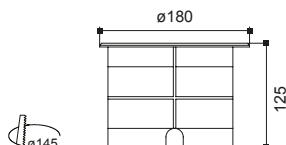
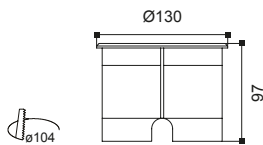

Realizar siempre correcta (mín. 300 mm.)

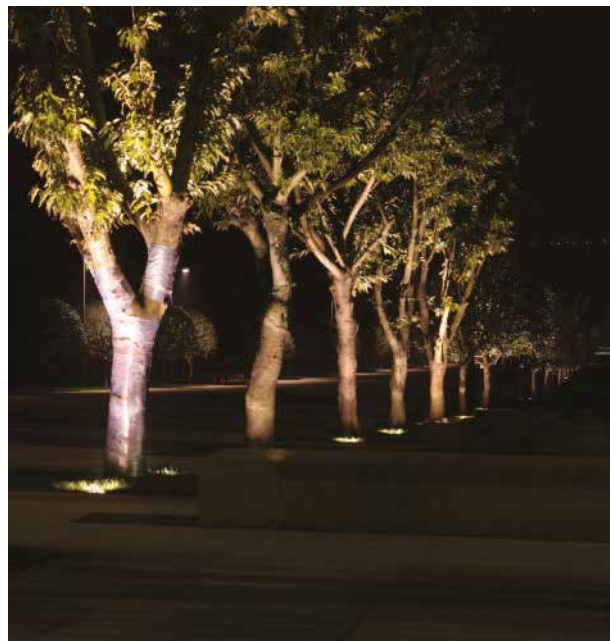

CÓDIGO	W	LM	K	ÓPTICA°	Ra/CRI				L	H		PVP
61062	6w	510Lm	3000K	30	>80	-20+50	INOX		130	97	104	113,95€
61063	6w	550Lm	4000K	30	>80	-20+50	INOX		130	97	104	113,95€
61065	12w	900Lm	3000K	30	>80	-20+50	INOX		180	125	145	182,75€
61066	12w	960Lm	4000K	30	>80	-20+50	INOX		180	125	145	182,75€

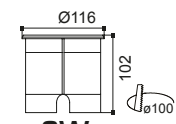

6W

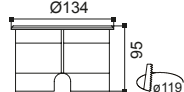

12W

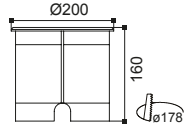

18W



CÓDIGO	W	LM	K	ÓPTICA°	Ra/CRI			L	H		PVP
62011	6w	570Lm	3000K	15	>80	-30+60	INOX	116	102	100	299,95€
62012	6w	570Lm	3000K	25	>80	-30+60	INOX	116	102	100	
62013	6w	570Lm	3000K	30	>80	-30+60	INOX	116	102	100	
62014	6w	570Lm	3000K	45	>80	-30+60	INOX	116	102	100	
62015	6w	570Lm	3000K	60	>80	-30+60	INOX	116	102	100	
62016	6w	600Lm	4000K	15	>80	-30+60	INOX	116	102	100	
62017	6w	600Lm	4000K	25	>80	-30+60	INOX	116	102	100	
62018	6w	600Lm	4000K	30	>80	-30+60	INOX	116	102	100	
62019	6w	600Lm	4000K	45	>80	-30+60	INOX	116	102	100	
62020	6w	600Lm	4000K	60	>80	-30+60	INOX	116	102	100	
62026	12w	1140Lm	3000K	15	>80	-30+60	INOX	134	95	119	494,95€
62027	12w	1140Lm	3000K	25	>80	-30+60	INOX	134	95	119	
62028	12w	1140Lm	3000K	30	>80	-30+60	INOX	134	95	119	
62029	12w	1140Lm	3000K	45	>80	-30+60	INOX	134	95	119	
62030	12w	1140Lm	3000K	60	>80	-30+60	INOX	134	95	119	
62031	12w	1200Lm	4000K	15	>80	-30+60	INOX	134	95	119	
62032	12w	1200Lm	4000K	25	>80	-30+60	INOX	134	95	119	
62033	12w	1200Lm	4000K	30	>80	-30+60	INOX	134	95	119	
62034	12w	1200Lm	4000K	45	>80	-30+60	INOX	134	95	119	
62035	12w	1200Lm	4000K	60	>80	-30+60	INOX	134	95	119	
62071	18w	1710Lm	3000K	8	>80	-30+60	INOX	200	160	178	749,95€
62072	18w	1710Lm	3000K	10	>80	-30+60	INOX	200	160	178	
62073	18w	1710Lm	3000K	17	>80	-30+60	INOX	200	160	178	
62074	18w	1710Lm	3000K	23	>80	-30+60	INOX	200	160	178	
62075	18w	1710Lm	3000K	28	>80	-30+60	INOX	200	160	178	
62076	18w	1710Lm	3000K	43	>80	-30+60	INOX	200	160	178	
62077	18w	1710Lm	3000K	58	>80	-30+60	INOX	200	160	178	
62078	18w	1710Lm	3000K	95	>80	-30+60	INOX	200	160	178	
62079	18w	1800Lm	4000K	8	>80	-30+60	INOX	200	160	178	
62080	18w	1800Lm	4000K	10	>80	-30+60	INOX	200	160	178	
62081	18w	1800Lm	4000K	17	>80	-30+60	INOX	200	160	178	
62082	18w	1800Lm	4000K	23	>80	-30+60	INOX	200	160	178	
62083	18w	1800Lm	4000K	28	>80	-30+60	INOX	200	160	178	
62084	18w	1800Lm	4000K	43	>80	-30+60	INOX	200	160	178	
62085	18w	1800Lm	4000K	58	>80	-30+60	INOX	200	160	178	
62086	18w	1800Lm	4000K	95	>80	-30+60	INOX	200	160	178	

ILUMINACIÓN EXTERIOR SUPERFICIE *OUTDOOR SURFACE LIGHTING* ÉCLAIRAGE DE SURFACE EXTÉRIEUR



LYOPRO
LEVEL



CÓDIGO	W	LM	K	VERSIÓN	ÓPTICA°	Ra/CRI			L	H	PVP
61080	3w	255Lm	3000K	Superficie	36	>80	-20+40	A	66	45	43,55€
61081	3w	270Lm	4000K	Superficie	36	>80	-20+40	A	66	45	43,55€
61083	7w	595Lm	3000K	Superficie	36	>80	-20+40	A	100	66	54,80€
61084	7w	630Lm	4000K	Superficie	36	>80	-20+40	A	100	66	54,80€
61086	12w	1020Lm	3000K	Superficie	36	>80	-20+40	A	100	66	73,05€
61087	12w	1080Lm	4000K	Superficie	36	>80	-20+40	A	100	66	73,05€
61089	3w	255Lm	3000K	Pincho	36	>80	-20+40	A	66	45	45,70€
61090	3w	270Lm	4000K	Pincho	36	>80	-20+40	A	66	45	45,70€
61092	7w	595Lm	3000K	Pincho	36	>80	-20+40	A	100	66	56,95€
61093	7w	630Lm	4000K	Pincho	36	>80	-20+40	A	100	66	56,95€
61095	12w	1020Lm	3000K	Pincho	36	>80	-20+40	A	100	66	75,25€
61096	12w	1080Lm	4000K	Pincho	36	>80	-20+40	A	100	66	75,25€

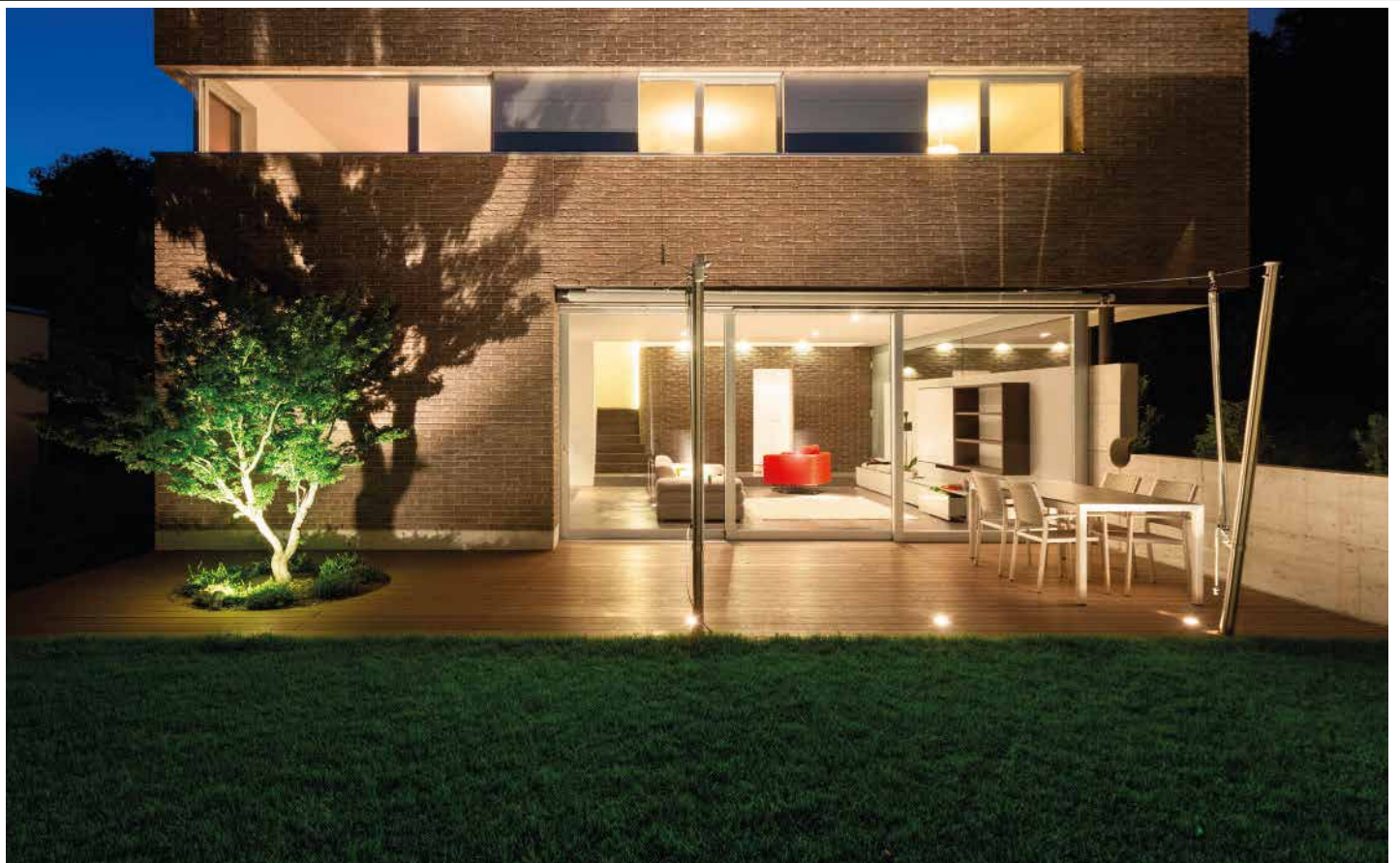

MIGUEL

CREE
LED CHIP

IP 66



IK 08

220-240V
50/60Hz

Inox
316

Alu



CE

3

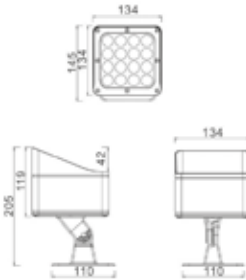

CÓDIGO	W	LM	K	Ra/CRI	°C	Color	ÓPTICA°	L W H			PVP
								L	W	H	
61210	9w	990Lm	4000K	>80	-25+45	GT	05	96	96	152	159,05€
61211	18w	2160Lm	4000K	>80	-25+45	GT	10 15	96	96	172	214,95€
61212	32w	3840Lm	4000K	>80	-25+45	GT	25 30 40 60	134	134	205	376,25€

ROY

CREE
LED CHIP

IP 66



IK 08

220-240V
50/60Hz

Inox
316

Alu



CE

3

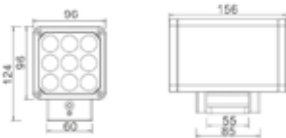

CÓDIGO	W	LM	K	Ra/CRI	°C	Color	ÓPTICA°	L W H			PVP
								L	W	H	
61213	18w	2160Lm	4000K	>80	-25+45	GT	05	96	156	124	376,25€
61214	36w	4320Lm	4000K	>80	-25+45	GT	10 15 25 30 40 60	96	156	164	430,00€

HANA

OSRAM
LED DRIVER

IP 66



IK 08

220-240V
50/60Hz

Inox
316

Alu



CE

3

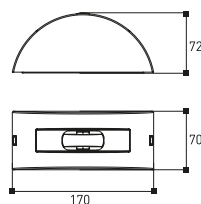

New
Available in November 23



CÓDIGO	W	LM	K	Ra/CRI	°C	Color	ÓPTICA°	L W H			PVP
								L	W	H	
61098	3w	240Lm	3000K	>80	-25+45	GT	10-180	170	72	70	89,95€
61099	3w	240Lm	4000K	>80	-25+45	GT	10-180	170	72	70	89,95€

EDEN

CREE LED CHIP

IP 66



IK 08

220-240V
50/60Hz

Inox 316

Alu



CE

3

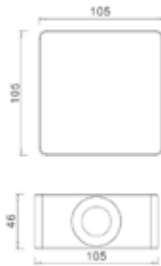

CÓDIGO	W	LM	K	Ra/CRI	°C	Color	ÓPTICA°	L	W	H	PVP
61102	4x2w	960Lm	4000K	>80	-25+45	GT	3	105	105	46	182,70€

AKINA

CREE LED CHIP

IP 66



IK 08

220-240V
50/60Hz

Inox 316

Alu



CE

3

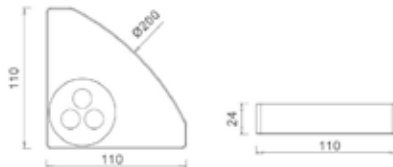

CÓDIGO	W	LM	K	Ra/CRI	°C	Color	ÓPTICA°	L	W	H	PVP
61105	3w	330Lm	4000K	>80	-25+45	GT	25	110	110	24	106,95€

AINARA

CREE LED CHIP

IP 66



220-240V
50/60Hz

Inox 316

Alu



CE

3

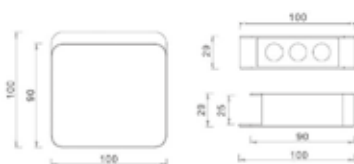

CÓDIGO	W	LM	K	Ra/CRI	°C	Color	ÓPTICA°	L	W	H	PVP
61108	6w	660Lm	4000K	>80	-25+45	GT	25	100	100	29	150,45€



Available in November 23



24W - 36W



72W

* ATOM 24V Power Supply not included

CÓDIGO	W	LM/W	K	VOLTAJE			ÓPTICA°				PVP
								L	W	H	
61110	24w	80lm/W	3000K	24V	-25+45	GT	30	1000	38	31	149,95€
61111	24w	80lm/W	4000K	24V	-25+45	GT	30	1000	38	31	149,95€
61113	24w	80lm/W	RGBW	24V	-25+45	GT	30	1000	38	31	199,95€
61114	36w	80lm/W	3000K	24V	-25+45	GT	30	1000	38	31	179,95€
61115	36w	80lm/W	4000K	24V	-25+45	GT	30	1000	38	31	179,95€
61117	36w	80lm/W	RGBW	24V	-25+45	GT	30	1000	38	31	219,95€
61122	72w	80lm/W	3000K	220V	-25+45	GT	30	1000	50	32,5	349,95€
61123	72w	80lm/W	4000K	220V	-25+45	GT	30	1000	50	32,5	349,95€
61125	72w	80lm/W	RGBW	220V	-25+45	GT	30	1000	50	32,5	429,95€

CONTROLADOR DMX

CÓDIGO	DESCRIPCIÓN	PVP
88590	Controlador DMX manual	139,95€



CÓDIGO	DESCRIPCIÓN	PVP
88591	Controlador DMX digital	599,95€



144W



216W



288W



432W



648W



CÓDIGO	W	LM/W	K			ÓPTICA°	ELECTRÓNICA	PVP
63003	144w	80Lm/W	30 3000K	-35+60	B <input type="checkbox"/>	8	SR	ON/OFF
63004	216w	80Lm/W	40 4000K	-35+60	A <input type="checkbox"/>	15	B	1-10V
63005	288w	80Lm/W	R RGB	-35+60	N <input type="checkbox"/>	30	C	DALI
63006	432w	80Lm/W	RW RGBW	-35+60		40	D	DMX
63007	648w	80Lm/W		-35+60		60		
						80		
						3060		



MAYA

EVER LIGHT
Led Chip

EAGLERISE
LED DRIVER

IP
54



IK
04

220-240V
50/60Hz

Alu

PMMA Difusser
Cover

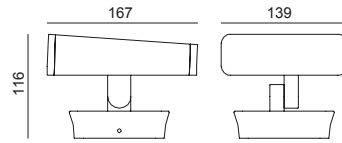

CÓDIGO	W	LM	K	Ra/CRI	°C	Color	ÓPTICA°	L W H			PVP
								L	W	H	
61120	12w	850Lm	3000K	>80	-20+40	A	110	167	139	116	150,45€
61121	12w	850Lm	4000K	>80	-20+40	A	110	167	139	116	150,45€

VISIA

IP
54

IK
06

220-240V
50/60Hz

Alu

GLASS
Difusser

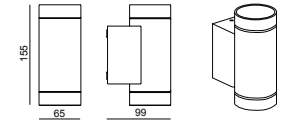
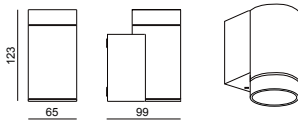

* Lámpara no incluida

CÓDIGO	TIPO LÁMPARA	VERSIÓN	Color	L W H			PVP
				L	W	H	
61124	1xGU-10	1 salida	A	99	65	123	45,70€
61127	2xGU-10	2 salidas	A	99	65	155	59,95€

DIANA

New

Available in November 23

IP
54

IK
06

220-240V
50/60Hz

Alu

GLASS
Difusser

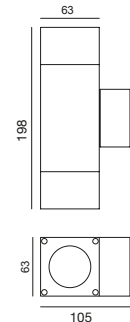
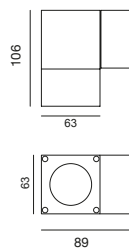

* Lámpara no incluida

CÓDIGO	TIPO LÁMPARA	VERSIÓN	Color	L W H			PVP
				L	W	H	
61460	1xGU-10	1 salida	A	89	63	106	45,70€
61461	2xGU-10	2 salidas	A	105	63	198	59,95€

VEGA

EVER LIGHT
Led Chip



IP
54



IK
06

220-240V
50/60Hz

Alu

PMMA Difusser
Cover



CE

3

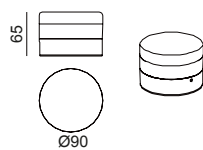

CÓDIGO	W	LM	K	Ra/CRI			ÓPTICA°	L	H	PVP
61141	12w	600Lm	3000K	>80	-20+40	A	110	90	65	80,60€
61142	12w	600Lm	4000K	>80	-20+40	A	110	90	65	80,60€

IRENE

CREE
LED CHIP



IP
54



IK
06

220-240V
50/60Hz

Alu

PMMA Difusser
Cover



CE

3

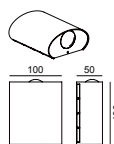

2x3W

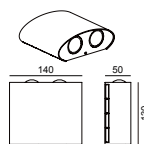

4x3W

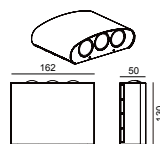

6x1W



CÓDIGO	W	LM	K	Ra/CRI			ÓPTICA°	L	W	H	PVP
61129	2x3w	230Lm	3000K	>80	-20+45	A	30	100	50	130	85,95€
61130	2x3w	230Lm	4000K	>80	-20+45	A	30	100	50	130	85,95€
61132	4x3w	600Lm	3000K	>80	-20+45	A	30	140	50	130	112,85€
61133	4x3w	600Lm	4000K	>80	-20+45	A	30	140	50	130	112,85€
61135	6x1w	500Lm	3000K	>80	-20+45	A	30	162	50	130	136,50€
61136	6x1w	500Lm	4000K	>80	-20+45	A	30	162	50	130	136,50€

LINUS

CREE
LED CHIP



IP
54



220-240V
50/60Hz

Alu

Glass
Tempered



CE

3

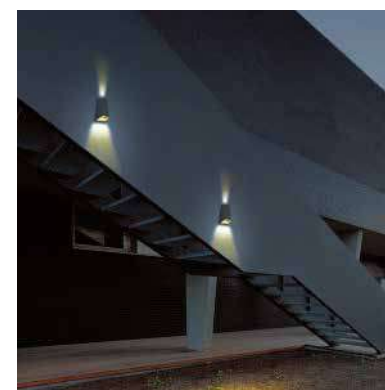
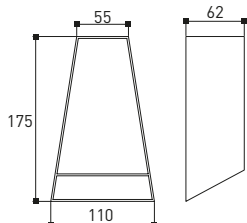

CÓDIGO	W	LM	K	Ra/CRI			ÓPTICA°	L	W	H	PVP
61180	2x4,5w	280Lm	3000K	>80	-20+50	A	15-80	175	110	62	91,35€
61181	2x4,5w	280Lm	4000K	>80	-20+50	A	15-80	175	110	62	91,35€

SYLAR

OSRAM LED CHIP | IP 65 | | | IK 07 | 220-240V 50/60Hz | Alu | PC Difusser | | | | CE |

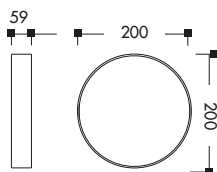

CÓDIGO	W	LM	K	Ra/CRI			ÓPTICA°	L	H	PVP
61074	18w	900lm	3000K	>80	-20+50	A	105	200	59	118,25€
61075	18w	900lm	4000K	>80	-20+50	A	105	200	59	118,25€

RAUL

IP 54 | IK 06 | 220-240V 50/60Hz | Alu | Glass Difusser Cover | | | | CE |

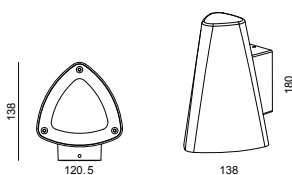

* Lámpara no incluida

CÓDIGO	TIPO LÁMPARA	VERSIÓN		L	W	H	PVP
61145	1xGU-10	1 Salida	A	120,5	138	180	51,55€

DALIA

CREE LED CHIP | LED DRIVER | IP 65 | | | IK 08 | 220-240V 50/60Hz | Alu | Glass Difusser Cover | | | | CE |

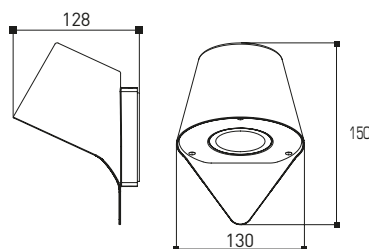

CÓDIGO	W	LM	K	Ra/CRI			ÓPTICA°	L	W	H	PVP
61177	7w	500lm	3000K	>80	-20+50	A	38	130	128	150	79,55€
61178	7w	500lm	4000K	>80	-20+50	A	38	130	128	150	79,55€

NILS

EVER LIGHT
Led Chip



IP
54



IK
04

220-240V
50/60Hz

Alu

PMMA
Difusser



CE

3

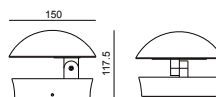

CÓDIGO	W	LM	K	Ra/CRI	°C	Óptica	ÓPTICA°	L	W	H	PVP
61159	13w	480Lm	3000K	>80	-20+40	A	100	150	150	117,5	106,40€
61160	13w	480Lm	4000K	>80	-20+40	A	100	150	150	117,5	106,40€

NEO

EVER LIGHT
Led Chip



IP
54



IK
06

220-240V
50/60Hz

Alu

PMMA
Difusser



CE

5

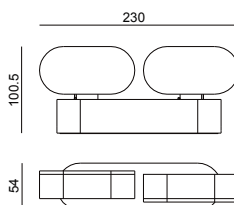

CÓDIGO	W	LM	K	Ra/CRI	°C	Óptica	ÓPTICA°	L	W	H	PVP
61162	2x6,5w	630Lm	3000K	>80	-20+50	A	100	230	54	100,5	106,40€
61163	2x6,5w	630Lm	4000K	>80	-20+50	A	100	230	54	100,5	106,40€

OTTO

CREE
LED CHIP



IP
54



220-240V
50/60Hz

Alu

Opal
PC



CE

5

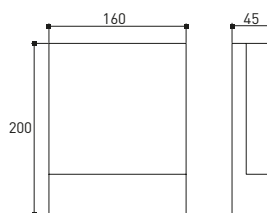

CÓDIGO	W	LM	K	Ra/CRI	°C	Óptica	ÓPTICA°	L	W	H	PVP
61184	8w	500Lm	4000K	>80	-20+50	A	116	160	45	200	91,35€

MOA

EVER LIGHT
Led Chip



IP
54



IK
07

220-240V
50/60Hz

Alu

PMMA
Difusser



CE

3

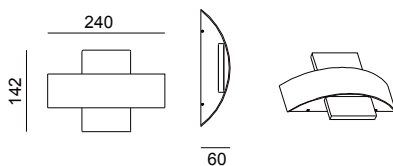
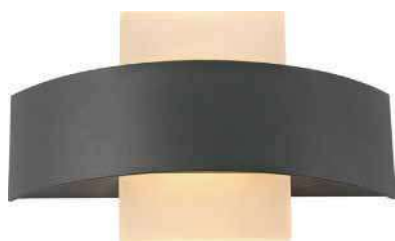

CÓDIGO	W	LM	K	Ra/CRI	°C	Color	ÓPTICA°	Dimensions			PVP
								L	W	H	
61165	10w	380Lm	3000K	>80	-20+50	A	100	240	60	142	101,60€
61166	10w	380Lm	4000K	>80	-20+50	A	100	240	60	142	102,10€

LEA

CREE
LED CHIP



IP
54



IK
07

220-240V
50/60Hz

Alu

PC
Difusser



CE

3

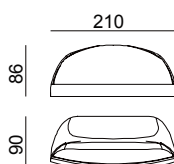

CÓDIGO	W	LM	K	Ra/CRI	°C	Color	ÓPTICA°	Dimensions			PVP
								L	W	H	
61168	12w	530Lm	3000K	>80	-20+40	A	100	210	90	86	91,35€
61169	12w	530Lm	4000K	>80	-20+40	A	100	210	90	86	91,35€

GEA

OSRAM
LED CHIP

IP
54

BATERÍA

Alu

PC
ABS

TOUCH
DIMMING



CE

3



Type - C USB cable x 1pc
Battery: 18650 2200MA 3.7V x 2pcs
Touch indication dimmer:
Touch 1 = 100% lumen - 4h light
Touch 2 = 60% lumen - 6h light
Touch 3 = 20% lumen - 16h light
Touch 4 = On / Off
Charging Time: 4.5hours

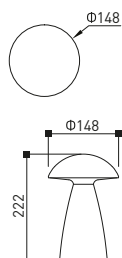

CÓDIGO	W	LM	K	Ra/CRI	°C	Color	ÓPTICA°	Dimensions			PVP
								L	W	H	
61205	4w	400Lm	4000K	>80	-20+40	B	80	148	222	107,45€	

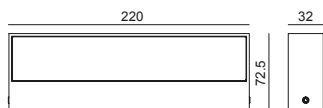

12W



Available in November 23

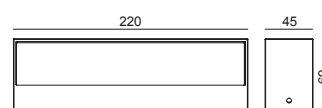

2x8W

CÓDIGO	W	LM	K	Ra/CRI			ÓPTICA°				PVP
								L	W	H	
61470	12w	780Lm	3000K	>80	-20+50	A	120	220	72,5	32	59,95€
61471	12w	840Lm	4000K	>80	-20+50	A	120	220	72,5	32	59,95€
61474	2x8w	2x520Lm	3000K	>80	-20+50	A	120	220	69	45	69,95€
61475	2x8w	2x560Lm	4000K	>80	-20+50	A	120	220	69	45	69,95€

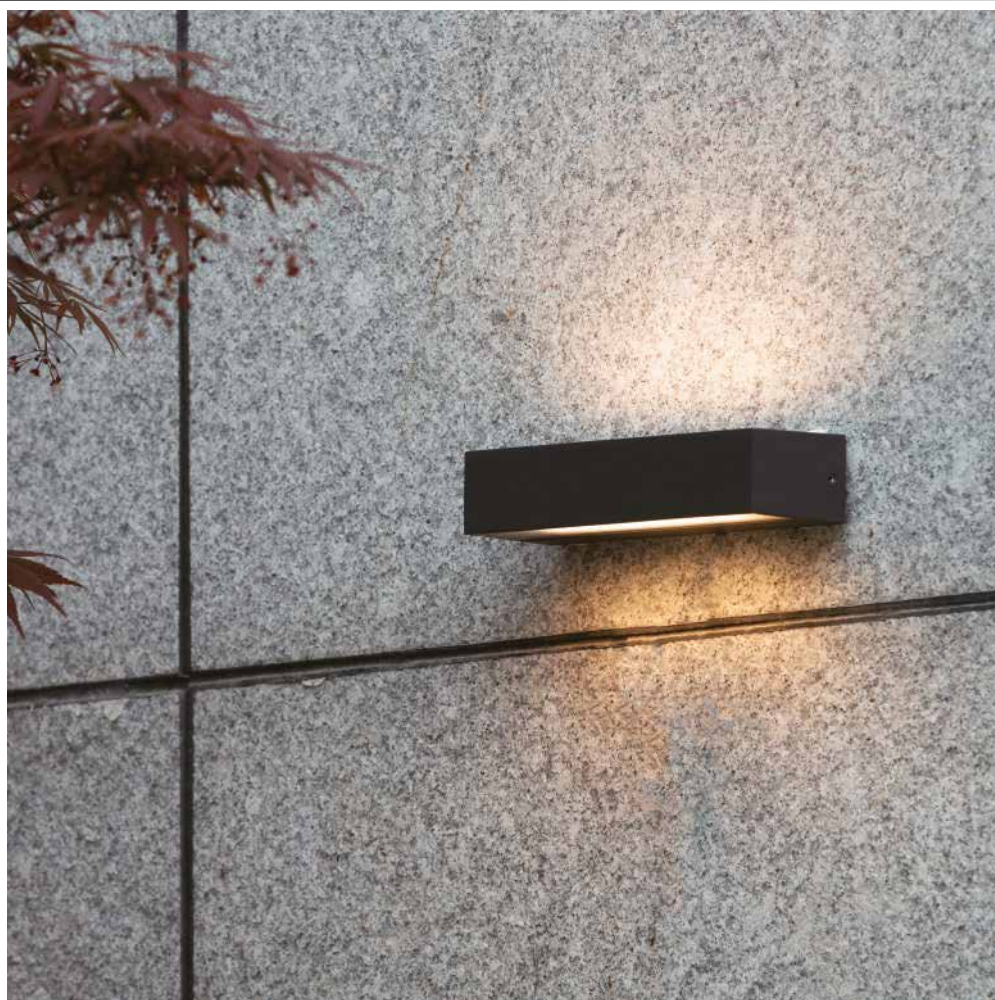

ILAN

CREE
LED CHIP

LED DRIVER

IP
54



220-240V
50/60Hz

Alu

GLASS
Difusser



CE

3

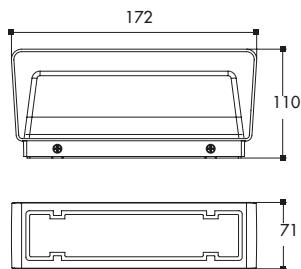

CÓDIGO	W	LM	K	Ra/CRI			ÓPTICA°	L	W	H	PVP
61172	3w	380Lm	4000K	>80	-20+50	A ■	45	172	110	71	84,40€

ILAN

IP
54



Alu

GLASS
Difusser



CE

3

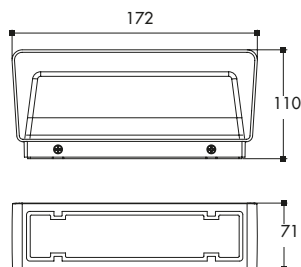

* Lámpara no incluida

CÓDIGO	TIPO LÁMPARA	MATERIAL		VERSIÓN	L	W	H	PVP
61175	1xR7S	Aluminio	A ■	2 Salidas	172	110	71	39,95€

ALBA

EVER LIGHT
Led Chip

EAGLE RISE
LED DRIVER

IP
54



IK
07

220-240V
50/60Hz

Alu

GLASS
Difusser



CE

3

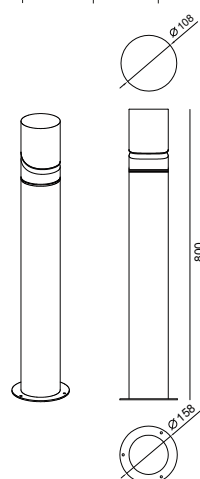

CÓDIGO	W	LM	K	Ra/CRI			ÓPTICA°	L	H	PVP
61147	12w	600Lm	3000K	>80	-20+40	A ■	110	108	173	139,95€
61148	12w	600Lm	4000K	>80	-20+40	A ■	110	108	173	139,95€
61150	12w	600Lm	3000K	>80	-20+40	A ■	110	108	800	199,95€
61151	12w	600Lm	4000K	>80	-20+40	A ■	110	108	800	199,95€

LEXIE

CREE
LED CHIP

EAGLE RISE
LED DRIVER

IP
54



IK
08

220-240V
50/60Hz

Alu

GLASS
Difusser



CE

5

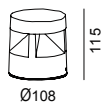

CÓDIGO	W	LM	K	Ra/CRI	°C	Color	ÓPTICA°	L			PVP
								L	H	H	
61153	8w	150Lm	3000K	>80	-20+40	A	90	108	115	94,95€	
61154	8w	150Lm	4000K	>80	-20+40	A	90	108	115	94,95€	

ARIA

CREE
LED CHIP

EAGLE RISE
LED DRIVER

IP
54



IK
08

220-240V
50/60Hz

Alu

GLASS
Difusser



CE

5

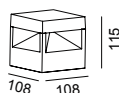

CÓDIGO	W	LM	K	Ra/CRI	°C	Color	ÓPTICA°	L			PVP
								L	W	H	
61156	8w	130Lm	3000K	>80	-20+60	A	90	108	108	115	99,95€
61157	8w	130Lm	4000K	>80	-20+60	A	90	108	108	115	99,95€

CARLOTA

OSRAM
LED CHIP

LED DRIVER

IP
65



IK
07

220-240V
50/60Hz

Alu

PC
Opal



CE

3

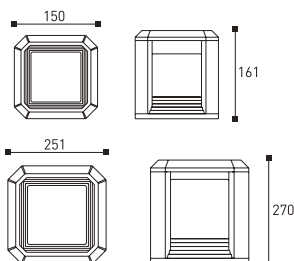

CÓDIGO	W	LM	K	Ra/CRI	°C	Color	ÓPTICA°	L			PVP
								L	W	H	
61186	12w	700Lm	3000K	>80	-20+50	A	270	150	150	161	113,90€
61187	12w	700Lm	4000K	>80	-20+50	A	270	150	150	161	113,90€
61189	20w	1000Lm	3000K	>80	-20+50	A	270	251	251	270	215,00€
61190	20w	1000Lm	4000K	>80	-20+50	A	270	251	251	270	215,00€

LEIA

OSRAM
LED CHIP



IP
54



IK
08

220-240V
50/60Hz

Alu

PC
Opal



CE

3

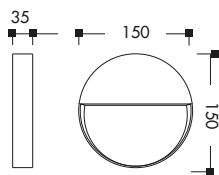

CÓDIGO	W	LM	K	Ra/CRI	°C	Paleta	ÓPTICA°	L	H	PVP
61192	5w	230Lm	3000K	>80	-20+50	A	80	150	35	67,70€
61193	5w	230Lm	4000K	>80	-20+50	A	80	150	35	67,70€

AGNES

OSRAM
LED CHIP



IP
54



IK
07

220-240V
50/60Hz

Alu

Glass
Tempered



CE

3

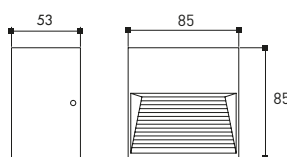

CÓDIGO	W	LM	K	Ra/CRI	°C	Paleta	ÓPTICA°	L	W	H	PVP
61201	3w	180Lm	3000K	>80	-20+50	A	65	85	85	53	56,95€
61202	3w	180Lm	4000K	>80	-20+50	A	65	85	85	53	56,95€

SIGAL

OSRAM
LED CHIP



IP
54



IK
07

220-240V
50/60Hz

Alu

PC
Opal



CE

3

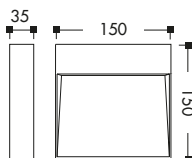

CÓDIGO	W	LM	K	Ra/CRI	°C	Paleta	ÓPTICA°	L	W	H	PVP
61195	5w	300Lm	3000K	>80	-20+50	A	270	150	150	35	67,70€
61196	5w	300Lm	4000K	>80	-20+50	A	270	150	150	35	67,70€

VIGGO

OSRAM
LED CHIP



IP
54



IK
07

220-240V
50/60Hz

Alu

PC
Opal



CE

3

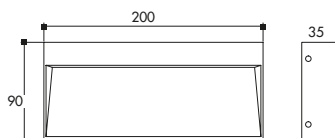

CÓDIGO	W	LM	K	Ra/CRI	°C	Paleta	ÓPTICA°	L	W	H	PVP
61198	7w	480Lm	3000K	>80	-20+50	A	80	200	90	35	79,85€
61199	7w	480Lm	4000K	>80	-20+50	A	80	200	90	35	79,85€

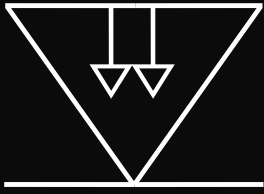

LYOPRO
LEVEL

ILUMINACIÓN SUBACUÁTICA
UNDERWATER LIGHTING
ÉCLAIRAGE SOUS-MARIN

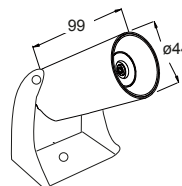

8W

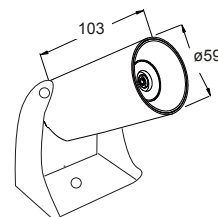

15W

* Fuente de alimentación no incluida

CÓDIGO	W	LM	K		Ra/CRI	ÓPTICA°				PVP
								L	H	
61349	8w	640Lm	4000K	INOX	>80	15	-30+60	44	90	215,00€
61350	8w	640Lm	4000K	INOX	>80	24	-30+60	44	90	215,00€
61351	8w	640Lm	4000K	INOX	>80	36	-30+60	44	90	215,00€
61352	8w	640Lm	4000K	INOX	>80	60	-30+60	44	90	215,00€
61364	15w	1200Lm	4000K	INOX	>80	10	-30+60	59	103	376,30€
61365	15w	1200Lm	4000K	INOX	>80	23	-30+60	59	103	376,30€
61366	15w	1200Lm	4000K	INOX	>80	36	-30+60	59	103	376,30€
61370	15w	900Lm	RGB	INOX	>80	10	-30+60	59	103	430,05€
61371	15w	900Lm	RGB	INOX	>80	23	-30+60	59	103	430,05€
61372	15w	900Lm	RGB	INOX	>80	36	-30+60	59	103	430,05€

CONTROLADOR RGB



CÓDIGO: 61312

PVP: 118,20€

CARACTERÍSTICAS

1. Controlador

temperatura de trabajo: -20-60°C
 voltaje de suministro: DC5V-24V
 salida: 3 canales
 modo de conexión: ánodo común
 dimensión externa: L 120 X W62 X H24mm
 tamaño del embalaje: L 185 X W145 X H52mm
 peso neto: 226g
 peso bruto: 320g
 consumo de energía estática: <1W
 corriente de salida: <8A (cada canal)
 potencia de salida: 12V: <288W, 24V: <576W

2. Mando

temperatura de trabajo: -20-60°C
 modo de fuente de alimentación: AAA * 3
 Voltaje de suministro: 1,5 V * 3
 frecuencia de transmisión: 2.4Ghz
 consumo de energía en espera: 0.015mW
 corriente de espera: 60uA
 corriente de trabajo: 200uA
 corriente de emisión: 1 0mA
 distancia de remate: unos 30 m
 tiempo en espera: 6 meses
 peso control remate: 94g

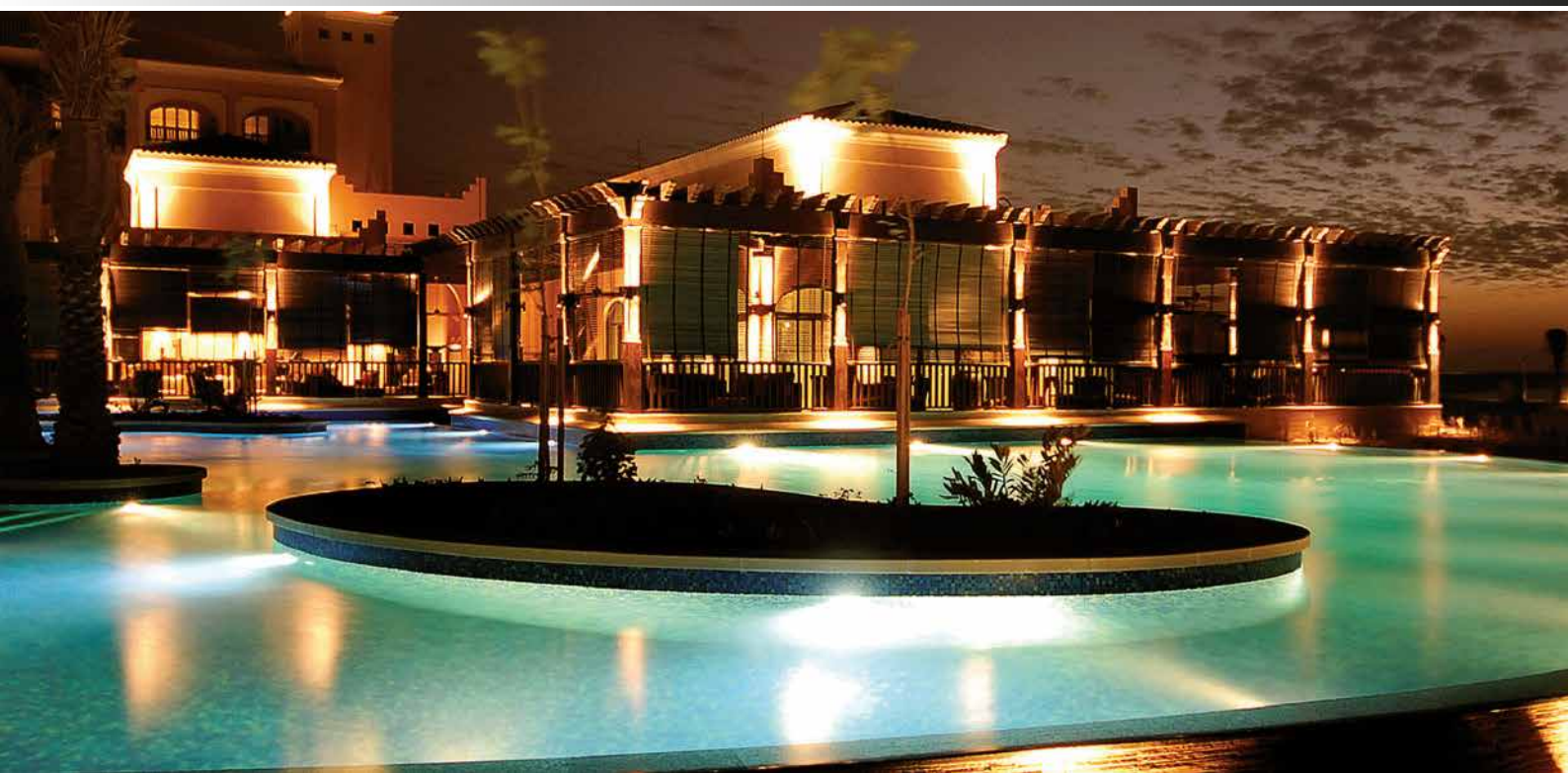

ARALE

EPISTAR
LED CHIP

IP
68

IK
07

DC 12V

Alu

Inox
316

RESIN
Cover

2 METROS

CE

3

6W

24W

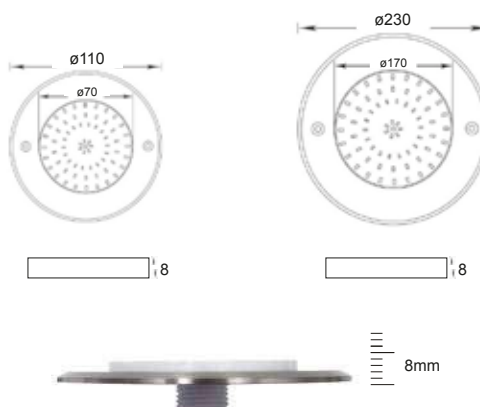

* Power supply 12v not included

CÓDIGO	W	LM	K	VERSIÓN		Ra/CRI	ÓPTICA°		L	H	PVP
61306	6w	480Lm	6000K	Superficie	INOX	>80	120	-20+40	110	8	149,95€
61307	6w	180Lm	RGB	Superficie	INOX	>80	120	-20+40	110	8	159,95€
61310	24w	1920Lm	6000K	Superficie	INOX	>80	120	-20+40	230	8	249,95€
61311	24w	800Lm	RGB	Superficie	INOX	>80	120	-20+40	230	8	269,95€

CONTROLADOR RGB



CÓDIGO: 61312
PVP: 118,20€

CARACTERÍSTICAS

1. Controlador

temperatura de trabajo: -20-60°C
voltaje de suministro: DC5V-24V
salida: 3 canales
modo de conexión: ánodo común
dimensión externa: L 120 X W62 X H24mm
tamaño del embalaje: L 185 X W145 X H52mm
peso neto: 226g
peso bruto: 320g
consumo de energía estática: <1W
corriente de salida: <8A (cada canal)
potencia de salida: 12V: <288W, 24V: <576W

2. Mando

temperatura de trabajo: -20-60°C
modo de fuente de alimentación: AAA * 3
Voltaje de suministro: 1,5 V * 3
frecuencia de transmisión: 2.4Ghz
consumo de energía en espera: 0.015mW
corriente de espera: 60uA
corriente de trabajo: 200uA
corriente de emisión: 1 0mA
distancia de remate: unos 30 m
tiempo en espera: 6 meses
peso control remate: 94g



INNA

EPISTAR
LED CHIP

IP
68

IK
07

DC 12V

Alu

Inox
316

PC
Cover

2 METROS

CE



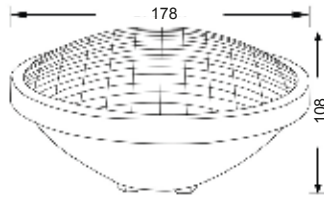

3

CE

3



* Power supply 12v not included

CÓDIGO	W	LM	K	VERSIÓN		Ra/CRI	ÓPTICA°		L	H	PVP
61316	24w	1500Lm	6000K	Empotrar	INOX 	>80	120	-20+40	178	108	139,70€
61317	24w	800Lm	RGB	Empotrar	INOX 	>80	120	-20+40	178	108	178,40€

* Controlador RGB incluido

NAMI

EPISTAR
LED CHIP

IP
68

IK
07

DC 12V

PC

2 METROS

CE



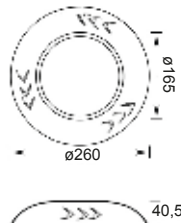

3

CE

3



* Power supply 12v not included

CÓDIGO	W	LM	K	VERSIÓN		Ra/CRI	ÓPTICA°		L	H	PVP
61302	24w	1500Lm	6000K	Superficie	INOX 	>80	120	-20+40	260	40,5	257,95€
61303	24w	800Lm	RGB	Superficie	INOX 	>80	120	-20+40	260	40,5	322,50€

* RGB controller included

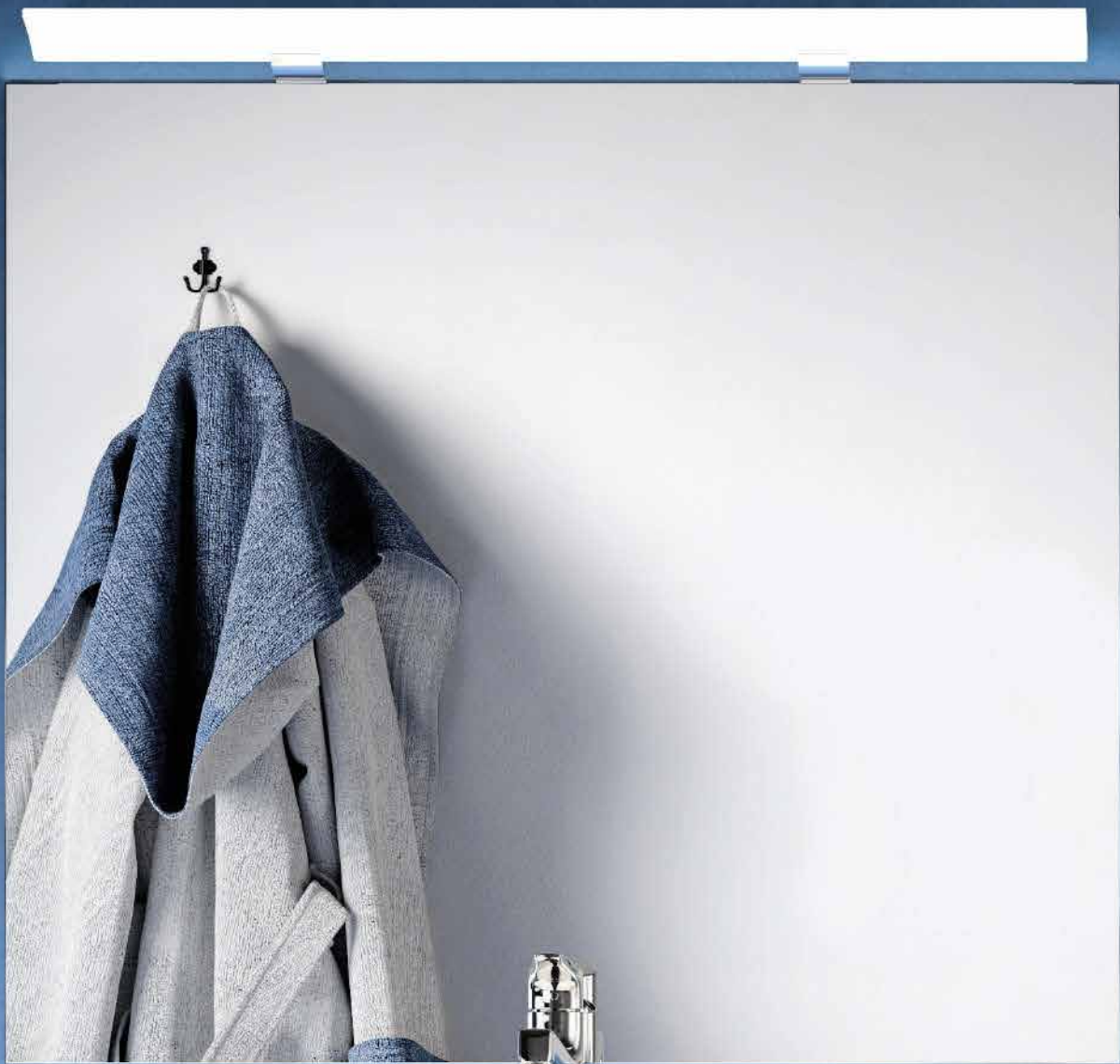

IDUMINACIÓN DE BAÑO
BATHROOM LIGHTING
ÉCLAIRAGE SALLE DE BAIN

ALEIX

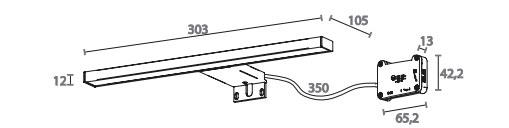

6W

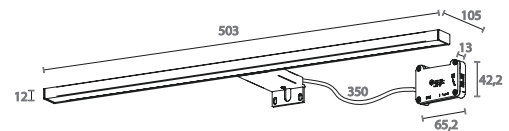

10W

CÓDIGO	W	LM	K	ÓPTICA°	Ra/CRI	°C	PVP
81268662	6w	420Lm	5700K	111	>80	-20+40	34,30€
81278662	10w	710Lm	5700K	111	>80	-20+40	49,35€

NORAH

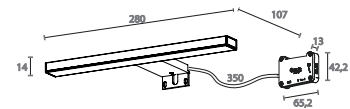

6W

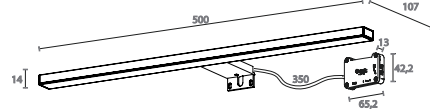

8W

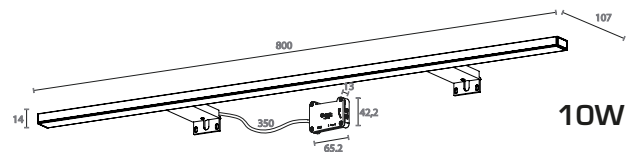

10W

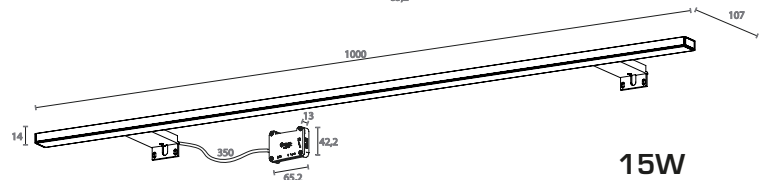

15W

CÓDIGO	W	LM	K	ÓPTICA°	Ra/CRI	°C	PVP
81248372	6w	460Lm	4000K	110	>80	-20+40	47,95€
81258372	8w	570Lm	4000K	110	>80	-20+40	64,40€
81268372	10w	790Lm	4000K	110	>80	-20+40	100,95€
81278372	15w	1260Lm	4000K	110	>80	-20+40	117,10€

SAHAR

IP 44 | 220-240V 50/60Hz | ABS | PC Opal Difusser | CE 5

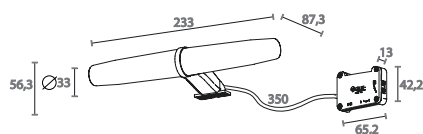

CÓDIGO	W	LM	K	ÓPTICA°	Ra/CRI		PVP
81200962	6w	420Lm	4000K	187	>80	-20+40	28,95€
81280962	6w	392Lm	5700K	187	>80	-20+40	28,95€

NOA

IP 44 | 220-240V 50/60Hz | PC | PC Opal Difusser | CE 5

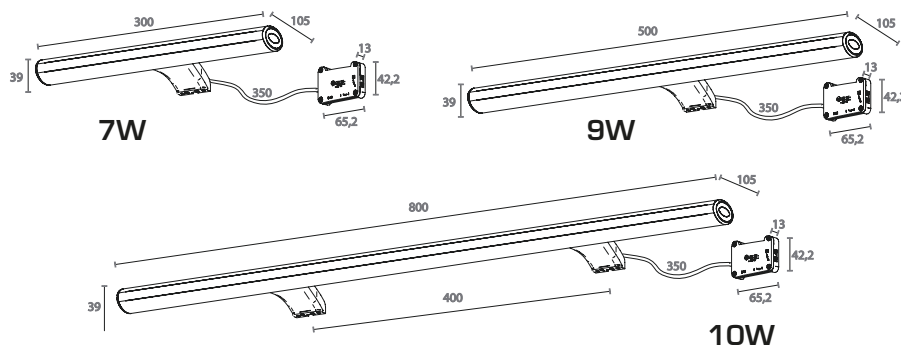

CÓDIGO	W	LM	K	ÓPTICA°	Ra/CRI		PVP
81256672	7w	640Lm	4000K	210	>80	-20+40	57,95€
81266672	9w	920Lm	4000K	210	>80	-20+40	77,30€
81276672	10w	1050Lm	4000K	210	>80	-20+40	117,10€

AFRODITA

IP 44 | 220-240V 50/60Hz | ABS | PC Opal Difusser | CE 5

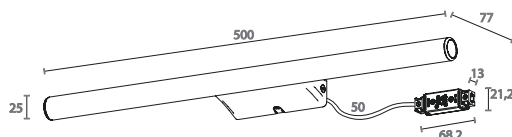

CÓDIGO	W	LM	K	ÓPTICA°	Ra/CRI		PVP
81265572	9w	830Lm	5700K	210	>80	-20+40	66,55€

VIOLETA

IP 44 |  | 220-240V / 50/60Hz | ABS | PC Opal Difusser |  | CE | 

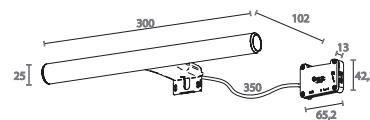

7W

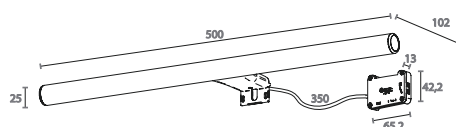

9W

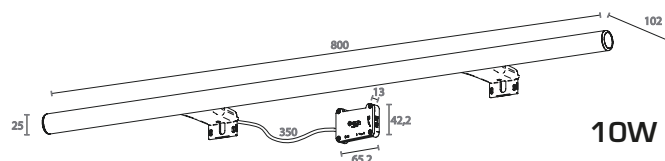

10W

CÓDIGO	W	LM	K	ÓPTICA°	Ra/CRI		PVP
81206272	7w	615Lm	5700K	210	>80	-20+40	45,70€
81216272	9w	830Lm	5700K	210	>80	-20+40	55,80€
81226272	10w	925Lm	5700K	210	>80	-20+40	77,95€

ALTEA

IP 44 |  | 220-240V / 50/60Hz | PC | PC Opal Difusser |  | CE | 

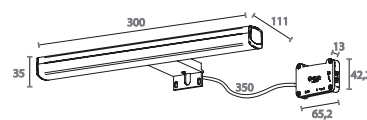

6W

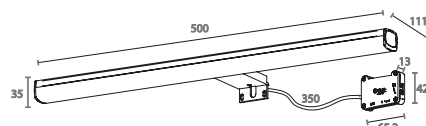

8W

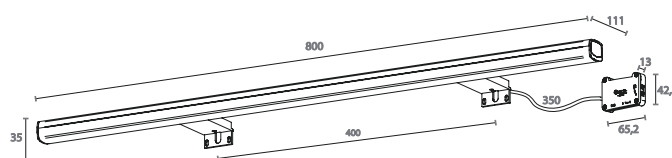

12W

CÓDIGO	W	LM	K	ÓPTICA°	Ra/CRI		PVP
81246182	6w	475Lm	4000K	195	>80	-20+40	66,15€
81256182	8w	635Lm	4000K	195	>80	-20+40	85,90€
81266182	12w	950Lm	4000K	195	>80	-20+40	138,60€

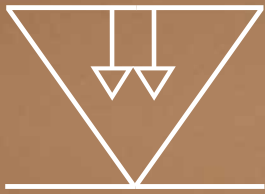

LYOPRO
LEVEL

ILUMINACIÓN DE EMERGENCIA EMERGENCY LIGHT LUMIÈRE D'URGENCE



FOGO

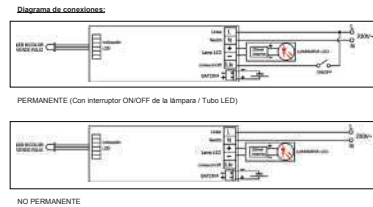
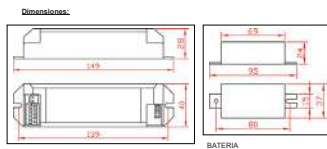

CÓDIGO	POTENCIA MAX EMER	BATERÍA	TIEMPO DE CARGA	AUTONOMÍA	PVP
62800	10w	Li-ión 7,4V 220mAh	24h	1h	76,95€

Kit de emergencia para luminarias de LED con driver interno que se alimentan directamente de la red. Ideal para downlight y lámparas (tipo dicroica GU10 - MR16) de LED de potencia hasta 10W. El equipo ajusta automáticamente la corriente de salida.

AMIRA

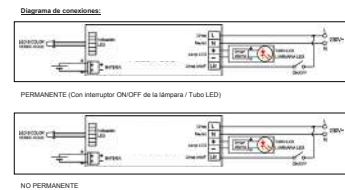

CÓDIGO	POTENCIA MAX EMER	BATERÍA	TIEMPO DE CARGA	AUTONOMÍA	PVP
62801	8-25w	Li-ión 11,1V 4,4Ah	24h	1h	108,95€

Kit de emergencia para luminarias de LED con driver interno que se alimentan directamente de la red. Adecuado para luminarias y tubos de LED T5/T8 de 8W a 25W. El equipo ajusta automáticamente la corriente de salida.

POLARIS

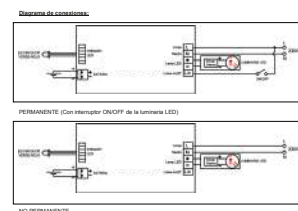
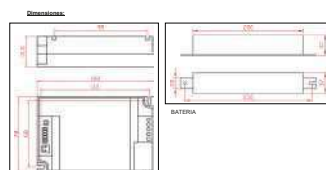

CÓDIGO	POTENCIA MAX EMER	BATERÍA	TIEMPO DE CARGA	AUTONOMÍA	PVP
62802	50w	Li-ión 11,1V 6,6Ah	24h	1h	233,65€

Kit de emergencia para luminarias de LED con driver interno que se alimentan directamente de la red. Adecuado para luminarias LED de potencia 50W máximo. El equipo ajusta automáticamente la corriente de salida.

ASTIN

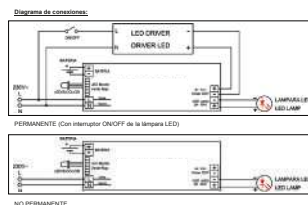
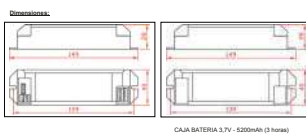

CÓDIGO	POTENCIA MAX EMER	BATERÍA	TIEMPO DE CARGA	AUTONOMÍA	TENSIÓN	PVP
62803	3-6w	Li-ión 3.7V A60:I67 (incorporada)	24h	1h	24V-60V	77,75€

Kit de emergencia para luminarias de LED tipo universal. Diseño innovador, batería incorporada en el cuerpo del kit, nos proporciona un diseño compacto y perfecto para instalar en luminarias de tamaño reducido. Dispone de un circuito de control de corriente que permite adaptar su tensión de salida a cualquier tipo de luminaria de LED, con un rango de tensión de trabajo entre 24V - 60V. El dispositivo se configura automáticamente ajustando una potencia de salida máxima de 6W dependiendo de la tensión de trabajo de la luminaria LED.

ESSIE

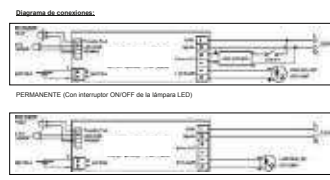
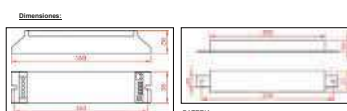

CÓDIGO	POTENCIA MAX EMER	BATERÍA	TIEMPO DE CARGA	AUTONOMÍA	TENSIÓN	PVP
62804	50w	Li-ión 12V 4,4 Ah	24h	1h	15V-120V	116,80€

Kit de emergencia para luminarias LED de tipo universal. Dispone de un circuito de control que permite adoptar sus características de salida de tensión y corriente a cualquier tipo de luminaria de LED con un rango de tensión de trabajo de 15V-120V. El dispositivo se configura automáticamente ajustando una potencia de salida en emergencia de 5W-24W.

MANLEY

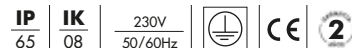
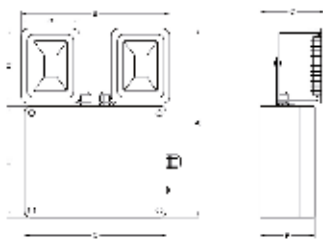

CÓDIGO	W	BATERÍA	LM	°C	AUTONOMÍA	FUNCIONAMIENTO	PVP
62830	2x10w	Li-ión 11.1V 4.4Ah	1600Lm	0 -40	1h	No permanente	
62831	2x10w	Li-ión 11.1V 4.4Ah	3200Lm	0 -40	1h	No permanente	

FUNCIONAMIENTO

- Trabajar con la tensión de red apagada, conectar el bloque y aplicar después la tensión de red a la instalación
- Comprobar que el LED verde se ilumina.
- Las baterías se suministran descargadas.

AUTOTEST

- Test mensual (1 vez al mes, duración 1 minuto): lámpara de emergencia.
- Test anual (1 vez al año, duración: 1 hora): batería (autonomía).

Resultados test.

1. LED verde iluminado fijo: red presente y funcionamiento correcto del equipo.
2. LED rojo iluminado: fallo del equipo (lámpara o batería).

Reset:

Una vez subsanado el fallo, desconectar la batería durante más de 30 segundos para hacer un reset y quitar la alarma del fallo.

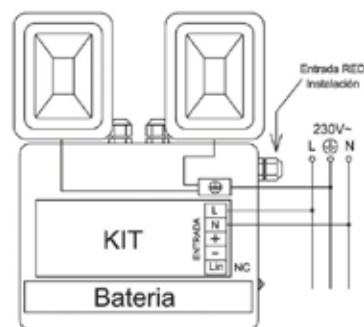

SALMA

IP 42 | IP 65 | 230V 50/60Hz | CE | 2

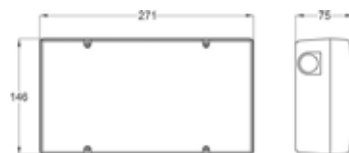

CÓDIGO	LÁMPARA	BATERÍA	TIEMPO DE CARGA	IP	AUTONOMÍA	LM	FUNCIONAMIENTO	DIFUSOR	PVP
62807	PCB 39 LED 2835	Ni-Cd 3.7V 2.2Ah	24h	42	1h	75Lm	No permanente/autotest	OPAL	34,95€
62820	PCB 39 LED 2835	Ni-Cd 3.7V 2.2Ah	24h	65	1h	75Lm	No permanente/autotest	OPAL	48,95€
62808	PCB 39 LED 2835	Ni-Cd 3.7V 2.2Ah	24h	42	1h	100Lm	No permanente/autotest	OPAL	38,95€
62821	PCB 39 LED 2835	Ni-Cd 3.7V 2.2Ah	24h	65	1h	100Lm	No permanente/autotest	OPAL	52,75€
62809	PCB 39 LED 2835	Ni-Cd 3.7V 2.2Ah	24h	42	1h	150Lm	No permanente/autotest	OPAL	44,95€
62822	PCB 39 LED 2835	Ni-Cd 3.7V 2.2Ah	24h	65	1h	150Lm	No permanente/autotest	OPAL	58,45€
62810	PCB 39 LED 2835	Ni-Cd 3.7V 2.2Ah	24h	42	1h	200Lm	No permanente/autotest	OPAL	47,75€
62823	PCB 39 LED 2835	Ni-Cd 3.7V 2.2Ah	24h	65	1h	200Lm	No permanente/autotest	OPAL	61,95€
62811	PCB 39 LED 2835	Ni-Cd 3.7V 2.2Ah	24h	42	1h	300Lm	No permanente/autotest	OPAL	57,50€
62824	PCB 39 LED 2835	Ni-Cd 3.7V 2.2Ah	24h	65	1h	300Lm	No permanente/autotest	OPAL	68,95€

ACCESORIOS SALMA IP42

GARRAS SOPORTE EMPOTRAR

CÓDIGO: 62812

PVP: 4,45€



MARCO EMPOTRAR

BLANCO CÓDIGO: 62813

GRAFITO CÓDIGO: 62814

GRIS CÓDIGO: 62815

PVP: 5,45€



TELMA

IP 20 | 230V 50/60Hz | CE | 2

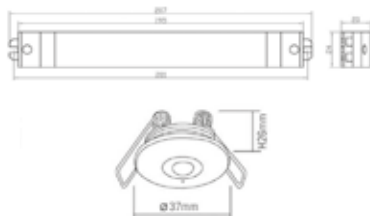

FOTOMETRÍA

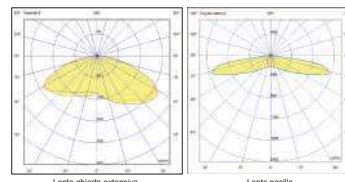

CÓDIGO	W	K	LAMPARA	BATERÍA	LM	AUTONOMÍA	ÓPTICA	FUNCIONAMIENTO	PVP
62836	3w	4000k	Led LG 1.5w	3.2V 1.5Ah	200Lm	1h	<u>E</u> Extensiva	<u>B</u> <input type="checkbox"/>	No permanente/autotest
62837	3w	4000k	Led LG 1.5w	3.2V 1.5Ah	200Lm	1h	<u>P</u> Pasillo	<u>N</u> <input type="checkbox"/>	75,95€
62838	3w	4000k	Led LG 1.5w	3.2V 1.5Ah	200Lm	3h			No permanente/autotest
62839	3w	4000k	Led LG 1.5w	3.2V 1.5Ah	200Lm	3h			No permanente/autotest

FUNCIONAMIENTO

- Trabajar con la tensión de red apagada, conectar el bloque y aplicar después la tensión de red a la instalación.
- Comprobar que el LED verde se ilumina.
- Las baterías se suministran descargadas.

TEST DE VERIFICACIÓN AUTOMÁTICO:

1. Test mensual, duración 120 segundos. LED verde parpadea rápido
2. Test anual, duración 1 hora. LED verde parpadea lento

INDICACIONES:

1. LED verde encendido fijo: funcionamiento correcto.
2. LED verde parpadea rápido: test mensual en ejecución.
3. LED verde parpadea lento: test anual en ejecución.
4. LED rojo encendido: fallo de lámpara (circuito abierto, corto circuito o fallo LED) Reset: desconectar la red, la batería antes de conectar la lámpara, presionar la ranura de test para iniciar test manual.
5. LED rojo parpadea rápido: fallo autonomía batería. Reset: presionar en la ranura de test 12 segundos y se reinicia el test de puesta en marcha. Si el test es favorable, el LED rojo se apaga.
6. LED rojo parpadea lento: fallo batería (batería incorrecta o desconectada).

TEST MANUAL:

Después del test de puesta en marcha, presionar la ranura de test. Inicia un test manual de 5 segundos de duración.



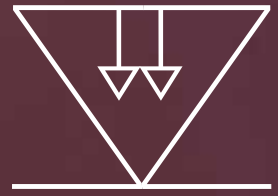

LYOPRO
LEVEL

SISTEMAS DE CONTROL
CONTROL SYSTEMS
SYSTÈMES DE CONTRÔLE

REGULADOR INALAMBRICO AC TRIAC

Ref.: 88503



Como sincronizar el controlador
How to sync controller
Comment synchroniser le contrôleur



Regulador inalámbrico AC TRIAC / AC TRIAC wireless controller

Control <i>Input Signal</i>	RF 2.4GHz + Push Dim
Voltaje de entrada <i>Input Voltage</i>	AC 100-240VAC
Tensión de salida <i>Output Voltage</i>	AC 100-240VAC
Corriente de salida <i>Output Current</i>	Max 1A
Potencia de salida <i>Output Power</i>	240W
Tamaño <i>Size</i>	L52 x W52 x H26 mm
Distancia <i>Distance</i>	30M
Temperatura de trabajo <i>Working Temperature</i>	-30°C~+55°C
PVP	49,95€

Instalación:

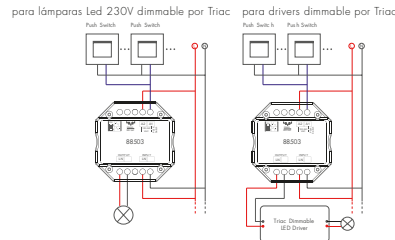

Aplicaciones:

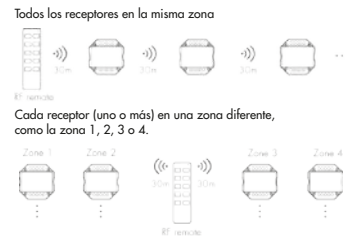

TUYA INTERRUPTOR ON/OFF 1,5A

Ref.: 88555



Tuya interruptor on/off 1,5A / Tuya interruptor on/off 1,5A

Control <i>Input Signal</i>	Tuya APP+RF+Push switch
Voltaje de entrada <i>Input Voltage</i>	AC 100-240V
Tensión de salida <i>Output Voltage</i>	AC 100-240V
Corriente de salida <i>Output Current</i>	Max 1,5A
Potencia de salida <i>Output Power</i>	360W
Tamaño <i>Size</i>	L52 x W52 x H26 mm
Distancia <i>Distance</i>	30M
Temperatura de trabajo <i>Working Temperature</i>	-30°C~+55°C
PVP	87,95€

Instalación:

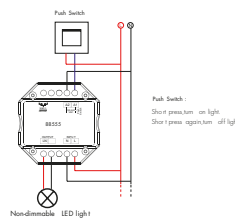

Aplicaciones:

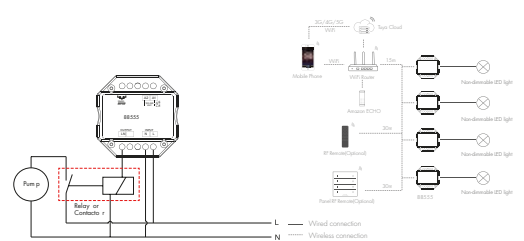

INTERRUPTOR INALAMBRICO ON/OFF 3A

Ref.: 88505



Como sincronizar el controlador
How to sync controller
Comment synchroniser le contrôleur



Control <i>Input Signal</i>	RF 2.4GHz + Push switch
Voltaje de entrada <i>Input Voltage</i>	AC 100-240VAC
Tensión de salida <i>Output Voltage</i>	AC 100-240VAC
Corriente de salida <i>Output Current</i>	Max 3A
Potencia de salida <i>Output Power</i>	720W
Tamaño <i>Size</i>	L52 x W52 x H26 mm
Distancia <i>Distance</i>	30M
Temperatura de trabajo <i>Working Temperature</i>	-30°C~+55°C
PVP	57,95€

Instalación:

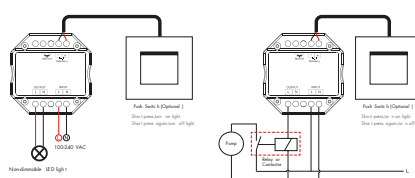

Aplicaciones:

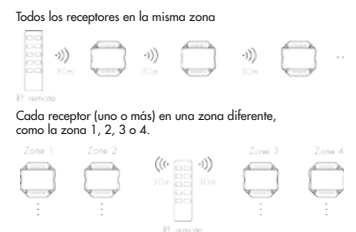

REGULADOR DALI 15A 24V

Ref.: 88564



Tuya regulador DALI 15A 24V | Tuya regulador DALI 15A 24V

Control Input Signal	DALI+Push Dim
Voltaje de entrada Input Voltage	12-24VDC
Tensión de salida Output Voltage	12-24VDC
Corriente de salida Output Current	1CH, 15A
Potencia de salida Output Power	360W
Tamaño Size	L175 x W45 x H27 mm
Distancia Distance	30M
Temperatura de trabajo Working Temperature	-30°C ~ +55°C
PVP	79,95€

Instalación:

88564 connect with DALI master

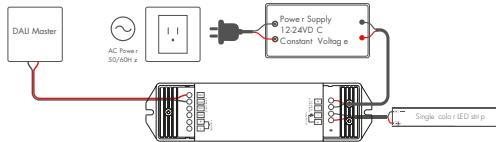

88564 connect with push switch

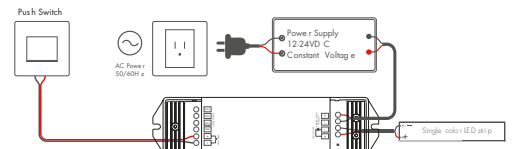

REGULADOR DALI 4X5A 24V

Ref.: 88565



Tuya regulador DALI 4X5A 24V | Tuya regulador DALI 4X5A 24V

Control Input Signal	DALI
Voltaje de entrada Input Voltage	12-24VDC
Tensión de salida Output Voltage	12-24VDC
Corriente de salida Output Current	4CH, 5A/CH
Potencia de salida Output Power	4x120W
Tamaño Size	L175 x W45 x H27 mm
Distancia Distance	30M
Temperatura de trabajo Working Temperature	-30°C ~ +55°C
PVP	97,95€

Instalación:

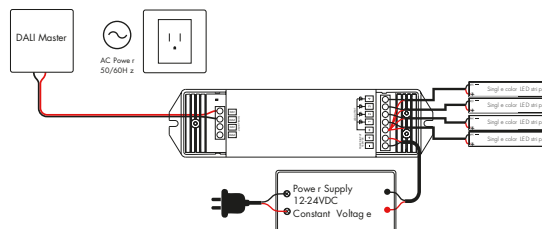

CONTROLADOR DALI A AC TRIAC 1,5A

Ref.: 88563

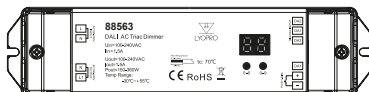

Tuya controlador DALI A AC TRIAC 1,5A | Tuya controlador DALI A AC TRIAC 1,5A

Control Input Signal	DALI
Voltaje de entrada Input Voltage	AC 100-240V
Tensión de salida Output Voltage	AC 100-240V
Corriente de salida Output Current	1CH, 1,5A
Potencia de salida Output Power	360W
Tamaño Size	L187 x W46 x H22 mm
Distancia Distance	30M
Temperatura de trabajo Working Temperature	-30°C ~ +55°C
PVP	98,95€

Instalación:

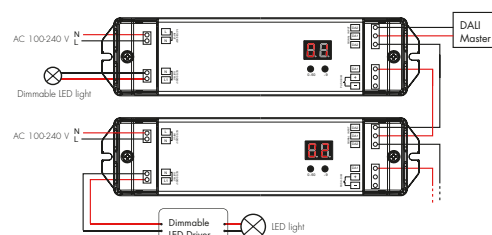

REGULADOR 0/1-10V PARA 1 LUMINARIA

Ref.: **88560**



Regulador 0/1-10V 1 luminaria | Regulador 0/1-10V 1 luminaria

Control <i>Input Signal</i>	RF 2.4GHz+Push Dim
Voltaje de entrada <i>Input Voltage</i>	AC100-240V
Corriente de salida <i>Output Current</i>	Max 1,5A
Salida de señal <i>Output signal</i>	0/1-10V (20mA)
Tamaño <i>Size</i>	L52 x W52 x H26 mm
Distancia <i>Distance</i>	30M
Temperatura de trabajo <i>Working Temperature</i>	-30°C~+55°C
PVP	68,95€

Instalación:

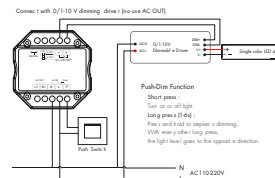

REGULADOR 0/1-10V PARA 4 LUMINARIAS

Ref.: **88561**



Regulador 0/1-10V 4 luminarias | Regulador 0/1-10V 4 luminarias

Control <i>Input Signal</i>	RF 2.4GHz
Voltaje de entrada <i>Input Voltage</i>	100-240VAC - 12VDC
Corriente de salida <i>Output Current</i>	4CH, 10mA/CH
Salida de señal <i>Output signal</i>	4x(0-10)VDC
Tamaño <i>Size</i>	L114 x W38 x H20 mm
Distancia <i>Distance</i>	30M
Temperatura de trabajo <i>Working Temperature</i>	-30°C~+55°C
PVP	79,95€

Instalación:

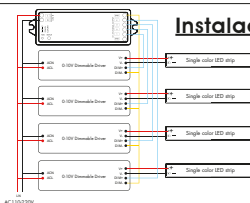

Aplicación:



REGULADOR 0/1-10V PARA 4 LUMINARIAS (REPETIDOR)

Ref.: **88562**



Regulador 0/1-10V 4 luminarias | Regulador 0/1-10V 4 luminarias

Control <i>Input Signal</i>	RF 2.4GHz
Voltaje de entrada <i>Input Voltage</i>	100-240VAC - 12VDC
Corriente de salida <i>Output Current</i>	0/1-10V: 20mA/CH Max 3A
Salida de señal <i>Output signal</i>	4X(0-10)VDC
Tamaño <i>Size</i>	L175 x W45 x H27 mm
Distancia <i>Distance</i>	30M
Temperatura de trabajo <i>Working Temperature</i>	-30°C~+55°C
PVP	109,95€

Instalación:

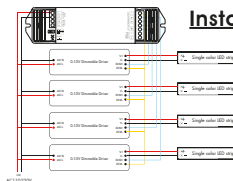

Aplicación:



REGULADOR 0/1-10V A AC TRIAC 2A

Ref.: **88568**



Regulador 0/1-10V A AC TRIAC 2A | Regulador 0/1-10V A AC TRIAC 2A

Control <i>Input Signal</i>	RF+0/1-10V+AC Push
Voltaje de entrada <i>Input Voltage</i>	AC 100-240V
Tensión de salida <i>Output Voltage</i>	AC 100-240V
Corriente de salida <i>Output Current</i>	Max 2A
Potencia de salida <i>Output Power</i>	480W
Tamaño <i>Size</i>	L175 x W45 x H27 mm
Distancia <i>Distance</i>	30M
Temperatura de trabajo <i>Working Temperature</i>	-30°C~+55°C
PVP	94,95€

Instalación:

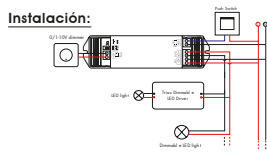

Aplicaciones:

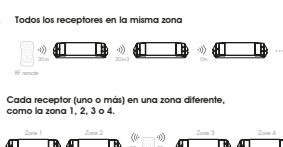

SMART DRIVER REGULABLE 15A

Ref.: 88530



Control <i>Imput Signal</i>	RF 2.4GHz+ Push Dim
Voltaje de entrada <i>Imput Voltage</i>	100-265VAC
Tensión de salida <i>Output Voltage</i>	10-45VDC
Corriente de salida <i>Output Current</i>	150-700mA
Potencia de salida <i>Output Power</i>	Max 15W
Tamaño <i>Size</i>	L51 x W41 x H30 mm
Distancia <i>Distance</i>	30M
Temperatura de trabajo <i>Working Temperature</i>	-30°C~+55°C
PVP	49,95€

Instalación:

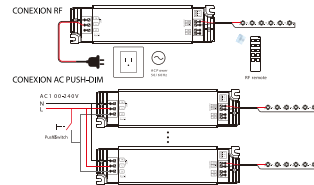

Aplicaciones:

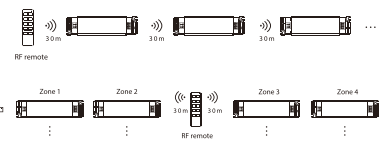

SMART DRIVER REGULABLE 36A

Ref.: 88532



Control <i>Imput Signal</i>	RF 2.4GHz+ Push Dim
Voltaje de entrada <i>Imput Voltage</i>	100-265VAC
Tensión de salida <i>Output Voltage</i>	10-52VDC
Corriente de salida <i>Output Current</i>	350-1200mA
Potencia de salida <i>Output Power</i>	Max 36W
Tamaño <i>Size</i>	L168,5 x W44 x H30 mm
Distancia <i>Distance</i>	30M
Temperatura de trabajo <i>Working Temperature</i>	-30°C~+55°C
PVP	79,95€

Instalación:

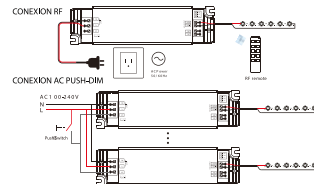

Aplicaciones:

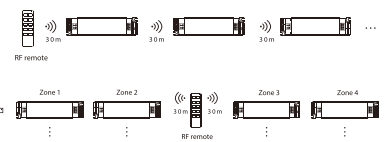

SMART DRIVER REGULABLE 50A

Ref.: 88533



Control <i>Imput Signal</i>	RF 2.4GHz+ Push Dim
Voltaje de entrada <i>Imput Voltage</i>	100-265VAC
Tensión de salida <i>Output Voltage</i>	10-52VDC
Corriente de salida <i>Output Current</i>	500-1750mA
Potencia de salida <i>Output Power</i>	Max 50W
Tamaño <i>Size</i>	L133 x W88 x H30 mm
Distancia <i>Distance</i>	30M
Temperatura de trabajo <i>Working Temperature</i>	-30°C~+55°C
PVP	98,95€

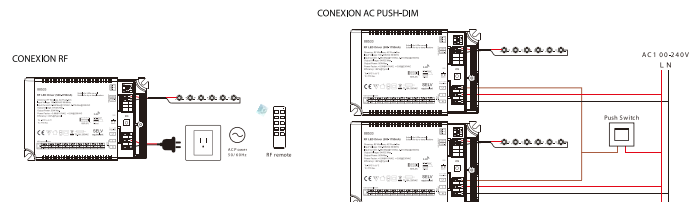

CONDICIONES GENERALES DE VENTA

FORMALIZAR UN PEDIDO IMPLICA LA ACEPTACIÓN DE ESTAS CONDICIONES DE VENTA GENERALES

Todas las ventas se realizan bajo las condiciones relacionadas a continuación. Cualquier especificación que no se ajuste a estas condiciones tendrá que ser antes aceptada por escrito por LYOPRO.

PRESUPUESTOS

Los presupuestos tendrán una validez máxima de 30 días naturales desde la fecha de su emisión.

GARANTÍA Y CALIDAD

Todos nuestros productos están garantizados (consultar en cada caso la ficha técnica en www.lyopro.es) contra cualquier defecto de fabricación. Esta garantía no cubre deterioros sufridos por el uso o aplicación indebida, incorrecta manipulación, una no correcta instalación cuando el producto haya sido usado fuera de su capacidad, maltratado, golpeado, así como cualquier otra falla atribuible al cliente o consumidor o cuando la falla sea original por el desgaste normal de las piezas debido a su funcionamiento o instalación. Queda fuera de garantía todo material manipulado por personal no autorizado por la empresa. Pequeñas diferencias entre nuestros productos en cuanto a tamaño, color, calidad o cualquier otra modificación en el producto, no serán motivo de reclamación por parte del comprador. Cualquier reclamación imputada en cuanto a cantidad, calidad u otros defectos serán comunicadas a LYOPRO, en un plazo máximo de 48 horas a la recepción de la mercancía, transcurrido este plazo no dará lugar a reclamación alguna. Para la ejecución de la garantía mediante abono o reposición es imprescindible recibir el material en cuestión para poder ser analizado y determinar que ésta procede. Requisito indispensable en toda garantía la presentación de factura y comprobante de pago y rellenando el RMA correspondiente. LYOPRO en continua mejora de la calidad y funcionalidad de sus productos se reserva el derecho a modificar o suprimir cualquiera de estos sin previo aviso sin que ello sea motivo de reclamación por parte del cliente.

PLAZO DE ENTREGA

Los plazos de entrega son sólo aproximados y sin compromiso, no admitiéndose demanda por daños y perjuicios por parte del cliente por demora de la entrega, ni otras demandas o indemnizaciones por incumplimientos contractuales. El incumplimiento del plazo de entrega no faculta al cliente a la rescisión del contrato de compra sin la concesión de un plazo prudencial de tiempo para solucionar dicha demora (importaciones de materiales y productos varios (60-90 días). Las causas de fuerza mayor (guerras, revoluciones, huelgas, catástrofes naturales, roturas de maquinaria, roturas de moldes o matrices, imposibilidad de adquisición de materia prima, interrupción del transporte, cierre de aduanas o cualquier otra medida oficial que pudiera afectar, etc.) nos da el derecho a demorar el plazo de entrega sin previo aviso. Cada operación es una expedición independiente, aunque varias de ellas formen parte de un mismo pedido.

PRECIOS / PORTES

Serán los establecidos en nuestra web a excepción de acuerdos explícitos confirmados por LYOPRO.

PORTES: Condiciones válidas únicamente en territorio peninsular español. Portes pagados a partir de 200€.

Islas Canarias: Portes pagados a partir de 600€. Debido a errores de imprenta, evolución de los productos o a las constantes fluctuaciones de la materia prima, LYOPRO se reserva el derecho de variar los precios sin previo aviso.

PEDIDOS

Todos los pedidos manipulados deberán confirmarse por escrito (devolviendo la hoja de pedido que se pase por correo electrónico) antes de que entren en funcionamiento. Todo pedido de fabricación y manipulación que supere los 1.500 € el cliente deberá abonar el 50% por adelantado antes del inicio de la fabricación (en concepto de reserva). En todos los pedidos de materiales que no hayan sido cursados por escrito (E-mail) LYOPRO no se hace responsable si hay disconformidad con lo que pidió y se sirvió. Ningún pedido cuya forma de pago sea transferencia entrará en funcionamiento antes de recibir el resguardo del pago.

ANULACIONES-DEVOLUCIONES DE PEDIDOS

No se aceptarán devoluciones transcurridos 15 días desde la entrega de material. Los pedidos pasados en firme no pueden ser anulados sin la conformidad de LYOPRO. En caso de devolución por causas ajenas a LYOPRO, el material será abonado con un 20% de demérito (con un mínimo de 10 €). No se aceptará ninguna devolución de materiales sin la autorización expresa de LYOPRO y con la hoja de devolución cumplimentada. De igual forma no se aceptará ninguna devolución a portes debidos si el motivo de dicha devolución es error de LYOPRO será LYOPRO quien envíe su agencia). No se aceptará responsabilidad ni reclamación alguna que sobrepase la reposición del material enviado o el pago de éste al precio al que fue adquirido. Ningún producto fabricado a medida ó traído expresamente para el cliente (que no se encuentre en stock habitual) será reembolsado, no teniendo derecho el cliente a reclamación alguna.

RESERVA DE PROPIEDAD

La mercancía suministrada queda en nuestra total propiedad hasta su pago. El derecho de propiedad subsiste aún después de que el comprador haya revendido el producto, hasta que no haya cancelado la deuda con LYOPRO.

TRANSPORTE

Cualquier anomalía del material recibido o incidencia del transporte deberá ser reflejada en el albarán que se firma al transportista o perderá el derecho a reclamación. El cliente deberá posteriormente darnos el aviso de la incidencia antes de las 24h posteriores a la entrega, no responsabilizándose en ningún caso si la reclamación es posterior a lo indicado. Es de competencia del cliente ejercer sus acciones con los transportistas en caso de pérdida, avería o retraso de la mercancía. El cliente tiene la obligación de examinar la mercancía en el momento de la entrega y anotar cualquier anomalía. No poner reparo en el talón o albarán de la agencia de transporte se entenderá que es de su conformidad. Si el cliente no ha dado instrucciones especiales de expedición, la mercancía se enviará según nuestro mejor parecer y por medio de transporte elegido por LYOPRO.

PAGO

Las condiciones de pago serán las acordadas con nuestros clientes. Los vencimientos de los pagos mediante cualquier documento de pago legalmente aceptado, deberán de respetarse puntualmente. En caso contrario estamos facultados a cargar los intereses de demora, así como los quebrantos ocasionados por la demora en el pago. Las demoras en el pago traen consigo con efecto inmediato la anulación de todos los compromisos de LYOPRO para con el cliente. El comprador no está autorizado a retener la totalidad a parte de los pagos vencidos por no habérsele reconocido alguna reclamación, ya que ésta no le exime de su compromiso de pago. Todo impagado o retraso en el pago anula la posibilidad del crédito, paralizando el suministro de materiales en tanto no se regularice la situación. Si esta situación fuera repetitiva, se procederá a comunicarlo a CRÉDITO & CAUCIÓN cancelándose el crédito de forma irrevocable.

FUERO

Para cuantas cuestiones y discrepancias se deriven de la presente operación, comprador y vendedor se someten expresamente a la competencia de los jueces y tribunales de los Juzgados de Valencia con renuncia a cualquier otro fuero propio o reserva de dominio que pudiera corresponder.

COSTAS Y GASTOS

Los gastos y costas judiciales, incluso honorarios de Abogado y derechos de Procurador, serán siempre por cuenta de la parte contratante que hubiera dado lugar a ellos por incumplimiento de estas condiciones generales de venta o del contrato en general.

DERECHO SUPLETORIO

El presente contrato de venta se regirá por lo aquí convenido y en su defecto por las normas del Código de Comercio Español para las ventas en España.

TARIFA

Los precios se indican en las tarifas vigentes en cada momento y se complementan con las políticas comerciales correspondientes. Están sujetos a cambios sin previo aviso. El precio final de la facturación es franco desde nuestro almacén de VALENCIA. No incluyen portes, seguros, desplazamientos no gastos de instalación. Los productos especiales no incluidos en la lista de precios están sujetos a cotización mediante oferta escrita o factura proforma, en las condiciones que en la misma se determinen. No se tomarán en consideración acuerdos verbales sobre este punto.

LEDs Y ORDENACIÓN S.L. (LYOPRO) CIF: B98495526

C/ SEQUIA DE RASCAÑA, 14, NAVE 6, 46210. PICAÑA (VALENCIA)

GENERAL SALE CONDITIONS

FORMALIZING AN ORDER IMPLIES THE ACCEPTANCE OF THESE GENERAL CONDITIONS OF SALE

All sales are made under the conditions listed below. Any specification that does not conform to these conditions will have to be previously accepted in writing by LYOPRO.

OFFERS

Budgets will be valid for a maximum of 30 calendar days from the date of issue.

WARRANTY AND QUALITY

All our products are guaranteed (consult the technical sheet in each case at www.lyopro.es) against any manufacturing defect. This guarantee does not cover deterioration suffered by improper use or application, incorrect handling, incorrect installation when the product has been used beyond its capacity, mistreated, hit, as well as any other failure attributable to the client or consumer or when the failure is due to the normal wear and tear of the parts due to its operation or installation. Any material handled by personnel not authorized by the company is out of warranty. Small differences between our products in terms of size, color, quality or any other modification in the product will not be grounds for a claim by the buyer. Any claim made in terms of quantity, quality or other defects will be communicated to LYOPRO, within a maximum period of 48 hours upon receipt of the merchandise, after this period will not give rise to any claim. For the execution of the guarantee through payment or replacement, it is essential to receive the material in question in order to be able to analyze it and determine that it is appropriate. An essential requirement in any guarantee is the presentation of the invoice and proof of payment and filling in the corresponding RMA. LYOPRO in continuous improvement of the quality and functionality of its products reserves the right to modify or delete any of these without prior notice without this being a reason for a claim by the client.

DELIVERY TERM

Delivery times are only approximate and without obligation, not accepting claims for damages by the customer for delayed delivery, or other claims or compensation for breaches of contract. Failure to comply with the delivery period does not authorize the client to terminate the purchase contract without granting a reasonable period of time to solve said delay (imports of materials and various products (60-90 days). Force majeure (wars, revolutions, strikes, natural catastrophes, machinery breakage, mold or die breakage, impossibility of acquiring raw materials, transport interruption, customs closure or any other official measure that may affect, etc.) gives us the right to delay the delivery period without prior notice. Each operation is an independent expedition, even if several of them are part of the same order.

PRICES / SHIPPING

FREIGHT: The transport price conditions for outside Spain will be defined with the opening of each customer's file.

ORDERS

All orders for cut or manipulated material must be confirmed in writing (returning the order form sent by email) before they go into operation. Any order for manufacturing and handling that exceeds €1,500, the customer must pay 50% in advance before the start of manufacturing (as a reserve). In all requests for materials that have not been made in writing (E-mail) LYOPRO is not responsible if there is disagreement with what was requested and served. No order whose payment method is transfer will start working before receiving the receipt of payment.

CANCELLATIONS-RETURNS OF ORDERS

Returns will not be accepted after 15 days from the delivery of material. Firm orders cannot be canceled without the consent of LYOPRO. In case of return for reasons beyond LYOPRO's control, the material will be paid with a 20% demerit (with a minimum of €10). No return of materials will be accepted without the express authorization of LYOPRO and with the completed return sheet. In the same way, no return to postage due will be accepted if the reason for said return is a LYOPRO error, LYOPRO will be the one who sends its agency). No liability or claim will be accepted that exceeds the replacement of the material sent or the payment thereof at the price at which it was purchased. No product made to measure or brought expressly for the client (that is not in regular stock) will be reimbursed, and the client is not entitled to any claim. Any special order, made to measure, that has cuts, etc..., will not be refundable.

PROPERTY RESERVATION

The supplied goods remain our full property until paid for. The property right subsists even after the buyer has resold the product, until the debt with LYOPRO has been cancelled.

TRANSPORT

Any anomaly of the material received or incidence of transport must be reflected in the delivery note that is signed to the carrier or you will lose the right to claim. The client must subsequently notify us of the incident within 24 hours after delivery, not being responsible in any case if the claim is made after to the indicated. It is the responsibility of the client to exercise their actions with the carriers in case of loss, breakdown or delay of the merchandise. The client has the obligation to examine the merchandise at the time of delivery and note any anomalies. Not objecting to the check or delivery note of the transport agency will be understood to be in accordance with it. If the client has not given special shipping instructions, the merchandise will be sent according to our best opinion and by means of transport chosen by LYOPRO.

PAYMENT TERMS

The payment terms will be those agreed with our clients. Payment due dates through any legally accepted payment document must be respected promptly. Otherwise, we are entitled to charge late-payment interest, as well as losses caused by late payment. Delays in payment bring with immediate effect the cancellation of all LYOPRO commitments to the client. The buyer is not authorized to withhold all or part of the overdue payments for not having recognized any claim, since this does not exempt him from his commitment to pay. Any non-payment or delay in payment annuls the possibility of credit, paralyzing the supply of materials until the situation is regularized. If this situation is repetitive, it will proceed to notify CREDIT & SURETY, canceling the credit irrevocably.

JURISDICTION

For any questions and discrepancies arising from this operation, buyer and seller expressly submit to the jurisdiction of the judges and courts of the Courts of Valencia, waiving any other jurisdiction or reservation of ownership that may correspond.

COSTS AND EXPENSES

Legal expenses and costs, including attorney's fees and Attorney's rights, will always be borne by the contracting party that would have given rise to them due to breach of these general conditions of sale or of the contract in general.

SUPPLEMENTARY RIGHT

This sales contract will be governed by what is agreed herein and, failing that, by the rules of the Spanish Commercial Code for sales in Spain.

LEDs Y ORDENACIÓN S.L. (LYOPRO) CIF: B98495526

C/ SEQUIA DE RASCAÑA, 14, NAVE 6, 46210. PICAÑA (VALENCIA)

CONDITIONS GENERALES DE VENTE

LA FORMALISATION D'UNE COMMANDE IMPLIQUE L'ACCEPTATION DES PRESENTES CONDITIONS GENERALES DE VENTE

Toutes les ventes sont faites dans les conditions énumérées ci-dessous. Toute spécification non conforme à ces conditions devra être préalablement acceptée par écrit par LYOPRO.

DEVIS

Les budgets seront valables pendant un maximum de 30 jours calendaires à compter de la date d'émission.

GARANTIE ET QUALITÉ

Tous nos produits sont garantis (consultez la fiche technique dans chaque cas sur www.lyopro.es) contre tout défaut de fabrication. Cette garantie ne couvre pas les détériorations subies par une mauvaise utilisation ou application, une mauvaise manipulation, une mauvaise installation lorsque le produit a été utilisé au-delà de ses capacités, maltraité, heurté, ainsi que toute autre défaillance imputable au client ou au consommateur ou lorsque la défaillance est due à l'usure normale des pièces due à son fonctionnement ou à son installation. Tout matériel manipulé par du personnel non autorisé par l'entreprise est hors garantie. Les petites différences entre nos produits en termes de taille, de couleur, de qualité ou toute autre modification du produit ne pourront donner lieu à réclamation de la part de l'acheteur. Toute réclamation formulée en termes de quantité, qualité ou autres défauts sera communiquée à LYOPRO, dans un délai maximum de 48 heures à réception de la marchandise, passé ce délai ne pourra donner lieu à aucune réclamation. Pour l'exécution de la garantie par paiement ou remplacement, il est indispensable de recevoir le matériel en question afin de pouvoir l'analyser et déterminer s'il est approprié. Une exigence essentielle de toute garantie est la présentation de la facture et de la preuve de paiement et le remplissage du RMA correspondant. LYOPRO dans l'amélioration continue de la qualité et de la fonctionnalité de ses produits se réserve le droit de modifier ou de supprimer l'un quelconque de ceux-ci sans préavis sans que cela puisse constituer un motif de réclamation de la part du client.

DÉLAI DE LIVRAISON

Les délais de livraison ne sont qu'approximatifs et sans engagement, n'acceptant pas les demandes de dommages-intérêts du client pour retard de livraison, ou d'autres réclamations ou compensations pour rupture de contrat. Le non-respect du délai de livraison n'autorise pas le client à résilier le contrat d'achat sans accorder un délai raisonnable pour résoudre ledit retard (importations de matériels et produits divers (60-90 jours). Force majeure (guerres, révolutions, grèves, catastrophes naturelles, bris de machines, bris de moule ou de matrice, impossibilité d'acquérir des matières premières, interruption de transport, fermeture douanière ou toute autre mesure officielle pouvant affecter, etc.) nous donne le droit de retarder le délai de livraison sans préavis. Chaque opération est une expédition indépendante, même si plusieurs d'entre elles font partie du même ordre.

PRIX / LIVRAISON

FRET: Les conditions du prix du transport pour l'extérieur de l'Espagne seront définies à l'ouverture du dossier de chaque client.

ORDRES

Toute commande de matériel découpé ou manipulé doit être confirmée par écrit (renvoi du bon de commande envoyé par mail) avant sa mise en service. Toute commande de fabrication et de manutention supérieure à 1 500 €, le client doit régler 50 % d'avance avant le début de la fabrication (à titre de réserve). Dans toutes les demandes de matériel qui n'ont pas été faites par écrit (E-mail), LYOPRO n'est pas responsable en cas de désaccord avec ce qui a été demandé et servi. Aucune commande dont le mode de paiement est le virement ne commencera à fonctionner avant la réception du paiement.

ANNULATIONS-RETOURS DE COMMANDES

Les retours ne seront pas acceptés après 15 jours à compter de la livraison du matériel. Les commandes fermes ne peuvent être annulées sans l'accord de LYOPRO. En cas de retour pour des raisons indépendantes de la volonté de LYOPRO, le matériel sera payé avec un démerite de 20% (avec un minimum de 10€). Aucun retour de matériel ne sera accepté sans l'autorisation expresse de LYOPRO et avec le bordereau de retour complété. De même, aucun retour en port dû ne sera accepté si le motif dudit retour est une erreur LYOPRO, LYOPRO sera celui qui envoie son agence). Aucune responsabilité ou réclamation ne sera acceptée au-delà du remplacement du matériel envoyé ou de son paiement au prix auquel il a été acheté. Aucun produit fabriqué sur mesure ou apporté exprès pour le client (qui n'est pas en stock régulier) ne sera remboursé, et le client ne pourra prétendre à aucune réclamation. Toute commande spéciale, sur mesure, comportant des découpes, etc..., ne sera pas remboursable.

RÉSERVATION DE PROPRIÉTÉ

Les marchandises livrées restent notre entière propriété jusqu'au paiement. Le droit de propriété subsiste même après que l'acheteur a revendu le produit, jusqu'à ce que la dette envers LYOPRO ait été annulée.

TRANSPORT

Toute anomalie du matériel reçu ou incidence du transport doit être mentionnée sur le bon de livraison qui est signé au transporteur ou vous perdrez le droit de réclamer. Le client doit ensuite nous signaler l'incident dans les 24 heures suivant la livraison, n'étant en aucun cas responsable si la réclamation est faite après à l'indiqué Il appartient au client d'exercer ses recours auprès des transporteurs en cas de perte, panne ou retard de la marchandise. Le client a l'obligation d'examiner la marchandise au moment de la livraison et de relever toute anomalie. Ne pas contester le chèque ou le bon de livraison de l'agence de transport sera considéré comme conforme à celui-ci. Si le client n'a pas donné d'instructions d'expédition particulières, la marchandise sera expédiée selon notre meilleur avis et par le moyen de transport choisi par LYOPRO.

CONDITIONS DE PAIEMENT

Les conditions de paiement seront celles convenues avec nos clients. Les dates d'échéance de paiement via tout document de paiement légalement accepté doivent être respectées rapidement. Dans le cas contraire, nous sommes en droit de facturer des intérêts de retard, ainsi que les pertes causées par un retard de paiement. Les retards de paiement entraînent avec effet immédiat l'annulation de tous les engagements de LYOPRO envers le client. L'acheteur n'est pas autorisé à retenir tout ou partie des retards de paiement pour n'avoir reconnu aucune créance, dès lors que cela ne le dispense pas de son engagement de payer. Tout non-paiement ou retard de paiement annule la possibilité de crédit, paralysant l'approvisionnement en matériaux jusqu'à ce que la situation soit régularisée. Si cette situation est répétitive, il procédera à la notification de CREDIT & SURETY, annulant irrévocablement le crédit.

JURIDICTION

Pour toutes questions et divergences découlant de cette opération, l'acheteur et le vendeur se soumettent expressément à la compétence des juges et des tribunaux des tribunaux de Valence, renonçant à toute autre juridiction ou réserve de propriété qui pourrait correspondre.

COÛTS ET DÉPENSES

Les frais et dépenses judiciaires, y compris les honoraires et droits d'avocat, seront toujours à la charge du cocontractant qui les a engendrés du fait de la violation des présentes conditions générales de vente ou du contrat en général.

DROIT SUPPLÉMENTAIRE

Ce contrat de vente sera régi par ce qui est convenu ici et, à défaut, par les règles du Code de commerce espagnol pour les ventes en Espagne.

LED S Y ORDENACIÓN S.L. (LYOPRO) CIF: B9849526

C/ SEQUIA DE RASCAÑA, 14, NAVE 6, 46210. PICAÑA (VALENCIA)



Lighting with you

Síguenos en:     

CENTRO LOGÍSTICO / LOGISTICS CENTER / CENTRE LOGISTIQUE

Pol. Ind. Alquería de Moret
Sequia Rascaña, 14, nave 6 · 46210 Picaña (Valencia)
(Spain)

Telfn.: +34 963 21 50 93 · info@lyopro.es

SHOWROOM:

Avenida Tres Cruces, 63
46014 Valencia
(Spain)

www.lyopro.es