

LYOPRO

Identity

2023-2024
NEW PRODUCT CATALOGUE

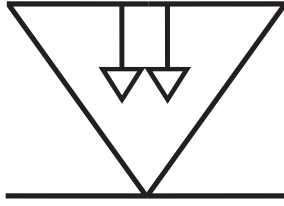

LYOPRO

Identity

Lighting with you

Nuestro catálogo IDENTITY representa nuestros orígenes, con una amplia gama en lámparas y luminarias.

Material destinado a satisfacer las necesidades del mercado de un nivel medio, dando soluciones en instalaciones como:

OFICINAS, RETAIL, EXTERIOR, INTERIOR, INDUSTRIA, RETROFIT.

Our IDENTITY catalog represents our origins, with a wide range of lamps and luminaires.

Material intended to meet the needs of the mid-level market, providing solutions in facilities such as:

OFFICES, RETAIL, EXTERIOR, INTERIOR, INDUSTRY, RETROFIT.

Notre catalogue IDENTITY représente nos origines, avec une large gamme de lampes et de luminaires.

Matériel destiné à répondre aux besoins du marché de niveau intermédiaire, apportant des solutions en installations telles que:

BUREAUX, COMMERCE, EXTÉRIEUR, INTÉRIEUR, INDUSTRIE, RETROFIT.

LYOPRO somos una empresa líder en el sector de la **iluminación LED en España**. Tras una larga experiencia en el sector de la iluminación, el material eléctrico y con motivo del creciente desarrollo y demanda de tecnología sostenible, hemos centrado la línea de negocio en la **iluminación LED**, consolidando un PRODUCTO y MARCA reconocida en el mercado nacional.

Tres gamas diferentes de productos forman nuestro portafolio: **LYOPRO IDENTITY, LYOPRO LED PROFILE y LYOPRO LEVEL** engloban todo tipo de soluciones diseñadas y adaptadas a las necesidades de nuestros clientes.

En la actualidad la empresa está formada por un **equipo de profesionales** cualificados y con formación específica en cada una de sus áreas de actividad.

Disponemos de una **red de comerciales** que cubre todo el territorio nacional garantizando el trato personal y directo con la empresa.

LYOPRO mantiene una cuidada selección y formación de su personal. Además, desarrolla **planes de formación y acuerdos de colaboración** con el fin de tener acceso a mano de obra cualificada, capaz de adaptarse a las distintas necesidades de nuestros clientes.

NUESTRA SEDE

La sede central de LYOPRO se encuentra ubicada en **Valencia**, en un entorno privilegiado por su ubicación y comunicaciones.

Las oficinas están equipadas con la tecnología y los recursos necesarios para adaptar de forma constante todos los procesos necesarios para el desarrollo de nuestra actividad como empresa líder en el sector de la fabricación y distribución.

Disponemos de unas instalaciones que proporcionan la capacidad de almacenaje necesaria para cumplir con la demanda creciente de nuestros clientes.

Ofrecemos un servicio rápido y de calidad

LYOPRO is a leading company in the **LED lighting sector in Spain**. After a long experience in the sector of lighting, electrical equipment and due to the growing development and demand for sustainable technology, we have focused the business line on **LED lighting**, consolidating a PRODUCT and BRAND recognized in the national market. And constantly growing in the international market.

Three different ranges of products make up our portfolio: **LYOPRO IDENTITY, LYOPRO LED PROFILE and LYOPRO LEVEL** encompass all kinds of solutions designed and adapted to the needs of our clients.

Currently the company is made up of a team of qualified **professionals with specific training** in each of its areas of activity.

We have a sales network that covers the entire national territory, guaranteeing personal and direct contact with the company.

LYOPRO maintains a careful selection and training of its personnel. In addition, it develops training plans and collaboration agreements in order to have access to qualified labor, capable of adapting to the different needs of our clients.

OUR HEADQUARTERS

LYOPRO's headquarters are located in **Valencia**, in a privileged environment due to its location and communications.

The offices are equipped with the necessary technology and resources to constantly adapt all the processes necessary for the development of our activity as a leading company in the manufacturing and distribution sector.

We have facilities that provide the storage capacity necessary to meet the growing demand of our customers.

We offer a fast and quality service

LYOPRO est une entreprise leader dans le secteur de **l'éclairage LED en Espagne**. Après une longue expérience dans le secteur de l'éclairage, des équipements électriques et en raison du développement et de la demande croissants de technologies durables, nous avons concentré la ligne d'activité sur **l'éclairage LED**, consolidant un PRODUIT et une MARQUE reconnus sur le marché national. Et en croissance constante sur le marché international. Trois gammes de produits différentes composent notre portefeuille: **LYOPRO IDENTITY, LYOPRO LED PROFILE et LYOPRO LEVEL** englobent toutes sortes de solutions conçues et adaptées aux besoins de nos clients.

Actuellement, l'entreprise est composée d'une **équipe de professionnels** qualifiés avec une formation spécifique dans chacun de ses domaines d'activité.

Nous disposons d'un réseau de vente qui couvre tout le territoire national, garantissant un contact personnel et direct avec l'entreprise.

LYOPRO maintient une sélection et une formation rigoureuses de son personnel. De plus, elle élabore des plans de formation et des ententes de collaboration afin d'avoir accès à une main-d'œuvre qualifiée, capable de s'adapter aux différents besoins de nos clients.

NOTRE SIÈGE SOCIAL

Le siège social de LYOPRO est situé à **Valence**, dans un environnement privilégié en raison de son emplacement et de ses communications.

Les bureaux sont équipés de la technologie et des ressources nécessaires pour adapter en permanence tous les processus nécessaires au développement de notre activité en tant qu'entreprise leader dans le secteur de la fabrication et de la distribution.

Nous disposons d'installations qui offrent la capacité de stockage nécessaire pour répondre à la demande croissante de nos clients.

Nous offrons un service rapide et de qualité

Lyopro Showroom es una nueva forma de enseñar nuestras luminarias al mundo. Un espacio creado para que nuestros clientes puedan ver en directo el impacto lumínico de las luminarias y su componente estético, diseño, material y calidad de todos y cada uno de los productos que conforman los distintos portafolios de nuestra marca. Un lugar construido a través de diferentes estancias para poder comprobar todo aquello que necesitas para seleccionar aquello que más le conviene a tu proyecto. Este proyecto de Showroom en Valencia nace de la necesidad de que nuestros clientes puedan conocer las luminarias que les recomendamos en cada uno de sus proyectos, es un espacio de creación en común con nuestros clientes. En nuestro Lyopro Showroow, podrás pasear por diferentes estancias en las que ver en funcionamiento nuestras luminarias más características de nuestros catálogos: LYOPRO IDENTITY, LYOPRO LED PROFILE, LYOPRO LEVEL.

Disponemos de una red de Técnicos Comerciales expertos en el asesoramiento con nuestros clientes.

Lyopro Showroom is a new way of exhibiting and displaying our lighting solutions to the public. We created this space so that our clients can have a closer look at all the details of the lighting products from the different collections, such as their aesthetic, design, materials and quality. A place built through different stays to be able to check everything you need to select what you most suits your project. We conceptualised the Valencia showroom with the needs of our clients in mind because we wanted to be able to showcase our products. At the Lyopro Showroom, you can walk through different rooms where you can see our most well known products from our catalogues: LYOPRO IDENTITY, LYOPRO LED PROFILE, LYOPRO LEVEL.

There is also always a commercial technician, who can assist you with their expertise.

Lyopro Showroom est une nouvelle façon de montrer nos luminaires au monde entier. Un espace créé pour que nos clients puissent voir en direct l'impact lumineux des luminaires et leur composante esthétique, leur design, leurs matériaux et la qualité de chacun des produits qui composent les différents portefeuilles de notre marque. Un endroit construit à travers différentes pièces pour vérifier tout ce dont vous avez besoin pour sélectionner ce qui convient à votre projet. Ce projet de showroom à Valence est né du besoin pour nos clients de connaître les luminaires que nous recommandons dans chacun de leurs projets, c'est un espace de création en commun avec nos clients. Dans notre Lyopro Showroom, vous pouvez vous promener dans différentes salles où vous pouvez voir en fonctionnement nos luminaires les plus caractéristiques de nos catalogues: LYOPRO IDENTITY, LYOPRO LED PROFILE, LYOPRO LEVEL.

Nous disposons d'un réseau de techniciens commerciaux experts pour conseiller nos clients



SHOWROOM:

Avenida Tres Cruces, 63 - 46014 Valencia







BOMBILLERÍA LED / LED BULB / AMPOULE À LED

						
Pag. 8 Dicroica SMD Opal	Pag. 8 Dicroica SMD	Pag. 9 Dicroica SMD Transparente	Pag. 9 Dicroica COB MINI	Pag. 9 Vela SMD	Pag. 10 Esférica SMD	Pag. 11-12 Estándar SMD
						
Pag. 13 Globo SMD	Pag. 14 Reflectora SMD	Pag. 15 Filamento COB	Pag. 16 Lineal SMD	Pag. 17 Lámpara G9-G4 SMD	Pag. 18 QR-111 SIGMA SMD	

LUMINARIAS GU-10 / GU-10 LUMINAIRES / LUMINAIRES GU-10

				
Pag. 20 CORAL Aros GU-10	Pag. 21 MOON Downlight Superficie GU-10	Pag. 21 MOON Proyector Superficie GU-10	Pag. 22 MOON Proyector Empotrar GU-10	Pag. 22 MOON Proyector Carril GU-10

DOWNLIGHTS LED / LED DOWNLIGHTS / DOWNLIGHTS LED

		
Pag. 24 ATLAS Empotrar Redondo	Pag. 25 HAMER Empotrar Redondo	Pag. 25 ORION Empotrar Redondo
		
Pag. 26 LEO Superficie Redondo	Pag. 26 LEO Superficie Cuadrado	Pag. 27 ZEUS Empotrar / Superficie

PANELES LED / LED PANELS / PANNEAUX LED



Pag. 28
Panel Backlit



Pag. 29
Panel Backlit UGR<19



Pag. 29
Marco Panel SITARA



Pag. 29
Accesorios Panele

TUBOS LED Y PANTALLAS ESTANCAS
LED TUBES AND WATERPROOF FITTINGS
TUBES LED ET ÉCRANS ÉTANCHES



Pag. 31
Tubo PC
SMD T8



Pag. 31
Tubo Cristal
SMD T8



Pag. 32
Tubo Carnicería
SMD T8



Pag. 32
Regleta ZOE



Pag. 33
Estanca DORIS

REGLETAS LED Y APLIQUES LED
LED STRIPES AND LED BULKHEAD
BANDES LED ET APPLIQUES LED



Pag. 34
Pantalla Estanca
Para Tubo Led

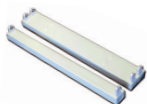

Pag. 34
Regleta Abierta



Pag. 34
Bombilla LINE



Pag. 36
Aplique Exterior GAMMA



Pag. 36
Aplique Exterior COSMOS
Redondo y Oval



Pag. 37
Aplique Exterior COSMOS
Medialuna



Pag. 37
Aplique Exterior COSMOS
Sensor Redondo y Oval



PROYECTORES LED / LED FLOODLIGHTS / PROJECTEURS LED

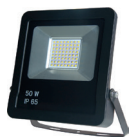

Pag. 39
Projector STAR

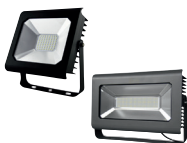

Pag. 40
Projector DIAMOND



Pag. 41
Projector BETTER



Pag. 41
Projector BETTER
Con sensor SMD



Pag. 42
Projector STAR
Con sensor SMD



Pag. 42
Projector STAR
RGB



Pag. 42
Projector
Recargable



Pag. 43
Projector con Tripode



Pag. 43
Projector Doble con Tripode

ACCESORIOS / ACCESSORIES / ACCESSOIRES



Pag. 43
Portalámparas GU-10
Convertidor E-27 a E-40



Pag. 43
Conector rápido
IP68



LYOPRO





Identity



LÁMPARAS LED
LED LAMPS
AMPOULES LED

Dicroica OPAL Smd 8W







Código Code Code	W	Lumens	Ø	Altura Height Hauteur	Color Color Couleur		PVP
10603	8w	630	50mm	55mm	3000K 	10 / 100	2,99 €
10604	8w	640	50mm	55mm	4000K 	10 / 100	2,99 €
10605	8w	650	50mm	55mm	6000K 	10 / 100	2,99 €

Dicroica Smd 7,5W



Available in October 23







Código Code Code	W	Lumens	Ø	Altura Height Hauteur	Color Color Couleur		PVP
10220	7,5w	600	50mm	56mm	2700K 	10 / 100	4,45 €
10221	7,5w	620	50mm	56mm	3000K 	10 / 100	4,45 €
10222	7,5w	640	50mm	56mm	4000K 	10 / 100	4,45 €

Dicroica Smd Dimmable 7,5W





Available in October 23



Código Code Code	W	Lumens	Ø	Altura Height Hauteur	Color Color Couleur		PVP
10224	7,5w	600	50mm	56mm	2700K 	10 / 100	8,95 €
10225	7,5w	620	50mm	56mm	3000K 	10 / 100	8,95 €
10226	7,5w	640	50mm	56mm	4000K 	10 / 100	8,95 €





Dicroica Transparente Smd 6W

Código Code Code	W	Lumens	Ø	Altura Height Hauteur	Color Color Couleur		PVP
10325	6w	680	50mm	60mm	3000K 	10 / 100	8,95 €
10324	6w	690	50mm	60mm	4000K 	10 / 100	8,95 €
10326	6w	700	50mm	60mm	6000K 	10 / 100	8,95 €

Dicroica Cob Mini 3W





Código Code Code	W	Lumens	Ø	Altura Height Hauteur	Color Color Couleur		PVP
10320	3w	240	35mm	40mm	3000K 	10 / 100	6,95 €
10321	3w	250	35mm	40mm	6000K 	10 / 100	6,95 €

Vela Smd 7W





Código Code Code	W	Lumens	Ø	Altura Height Hauteur	Color Color Couleur		PVP
10430	7w	600	37mm	98mm	3000K 	10 / 100	2,70 €
10427	7w	610	37mm	98mm	4000K 	10 / 100	2,70 €
10431	7w	620	37mm	98mm	6000K 	10 / 100	2,70 €

Esférica Smd 7W



Código Code Code	W	Lumens	Ø	Altura Height Hauteur	Color Color Couleur		PVP
10434	7w	600	45mm	77mm	3000K 	10 / 100	2,70 €
10429	7w	610	45mm	77mm	4000K 	10 / 100	2,70 €
10435	7w	620	45mm	77mm	6000K 	10 / 100	2,70 €



Código Code Code	W	Lumens	Ø	Altura Height Hauteur	Color Color Couleur		PVP
10436	7w	600	45mm	78mm	3000K 	10 / 100	2,70 €
10433	7w	610	45mm	78mm	4000K 	10 / 100	2,70 €
10437	7w	620	45mm	78mm	6000K 	10 / 100	2,70 €



Estándar Smd

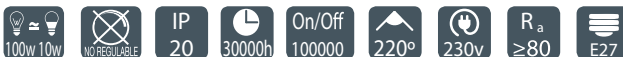





Código Code Code	W	Lumens	Ø	Altura Height Hauteur	Color Color Couleur		PVP
10042	10w	1000	60mm	112mm	3000K 	10 / 100	2,80 €
10041	10w	1040	60mm	112mm	4000K 	10 / 100	2,80 €
10043	10w	1080	60mm	112mm	6000K 	10 / 100	2,80 €
10352	15w	1440	60mm	112mm	3000K 	10 / 100	4,45 €
10354	15w	1470	60mm	112mm	4000K 	10 / 100	4,45 €
10353	15w	1500	60mm	112mm	6000K 	10 / 100	4,45 €



Estándar Dimmable 10W



Código Code Code	W	Lumens	Ø	Altura Height Hauteur	Color Color Couleur		PVP
10450	10w	860	60mm	110mm	3000K 	10 / 100	8,25 €
10451	10w	880	60mm	110mm	4000K 	10 / 100	8,25 €
10452	10w	900	60mm	110mm	6000K 	10 / 100	8,25 €

Estándar 10W 12/24V



12/24V

Corriente
AC/DC

NO REGULABLE

IP
20

30000h

On/Off
100000

220°

12/24v

R_a
≥80

E 27

Código Code Code	W	Lumens	Ø	Altura Height Hauteur	Color Color Couleur		PVP
10035	10w	860	60mm	110mm	3000K 	10 / 100	7,95 €
10036	10w	870	60mm	110mm	4000K 	10 / 100	7,95 €
10037	10w	890	60mm	110mm	6000K 	10 / 100	7,95 €

Estándar con Sensor Crepuscular



OFF
ON
Twilight
Sensor

NOT DIMMABLE

IP
20

30000h





On/Off
100000

160°





230v

R_a
≥80





E 27

Código Code Code	W	Lumens	Ø	Altura Height Hauteur	Color Color Couleur		PVP
10453	10w	1040	60mm	112mm	3000K 	10 / 100	13,95 €
10454	10w	1060	60mm	112mm	4000K 	10 / 100	13,95 €
10455	10w	1080	60mm	112mm	6000K 	10 / 100	13,95 €

Globo Smd G95 12W

Código Code Code	W	Lumens	Ø	Altura Height Hauteur	Color Color Couleur		PVP
10356	12w	1160	95mm	138mm	3000K 	1 / 20	11,95 €
10050	12w	1180	95mm	138mm	4000K 	1 / 20	11,95 €
10357	12w	1200	95mm	138mm	6000K 	1 / 20	11,95 €





Globo Smd G120 15W

Código Code Code	W	Lumens	Ø	Altura Height Hauteur	Color Color Couleur		PVP
10358	15w	1440	120mm	157mm	3000K 	1 / 20	14,95 €
10051	15w	1470	120mm	157mm	4000K 	1 / 20	14,95 €
10359	15w	1500	120mm	157mm	6000K 	1 / 20	14,95 €



Reflectora Smd R50 6W



Código Code Code	W	Lumens	Ø	Altura Height Hauteur	Color Color Couleur		PVP
10046	6w	530	50mm	88mm	3000K 	10 / 100	6,25 €
10446	6w	540	50mm	88mm	4000K 	10 / 100	6,25 €
10246	6w	550	50mm	88mm	6000K 	10 / 100	6,25 €

Reflectora R65 - R80 - R90 Smd



R65











R80





R90



Código Code Code	W	Lumens	Ø	Altura Height Hauteur	Color Color Couleur		PVP
10047	8w	700	63mm	104mm	3000K 	10 / 80	7,25 €
10447	8w	710	63mm	104mm	4000K 	10 / 80	7,25 €
10247	8w	720	63mm	104mm	6000K 	10 / 80	7,25 €
10049	12w	930	80mm	110mm	3000K 	10 / 60	9,25 €
10449	12w	950	80mm	110mm	4000K 	10 / 60	9,25 €
10249	12w	970	80mm	110mm	6000K 	10 / 60	9,25 €
10048	15w	1260	90mm	126mm	3000K 	10 / 50	11,95 €
10248	15w	1300	90mm	126mm	6000K 	10 / 50	11,95 €



Filamento VELA Cob 4W

Código Code Code	W	Lumens	Ø	Altura Height Hauteur	Color Color Couleur		PVP
10344	4w	400	35mm	100mm	2700K 	10 / 100	4,85 €



Filamento Esférica Cob 4W

Código Code Code	W	Lumens	Ø	Altura Height Hauteur	Color Color Couleur		PVP
10347	4w	400	45mm	75mm	2700K 	10 / 100	4,85 €

Filamento Esférica Cob 4W



Código Code Code	W	Lumens	Ø	Altura Height Hauteur	Color Color Couleur		PVP
10345	4w	400	45mm	72mm	2700K 	10 / 100	4,85 €

Filamento Estándar Cob 8W

Código Code Code	W	Lumens	Ø	Altura Height Hauteur	Color Color Couleur		PVP
10343	8w	800	60mm	104mm	2700K 	10 / 50	6,50 €





LINEAL Smd 5W - 10W







Código Code Code	W	Lumens	Ø	Altura Height Hauteur	Color Color Couleur		PVP
10112	5w	530	27mm	78mm	3000K 	1 / 20 / 100	9,95 €
10110	5w	540	27mm	78mm	4000K 	1 / 20 / 100	9,95 €
10113	5w	550	27mm	78mm	6000K 	1 / 20 / 100	9,95 €
10114	10w	1080	27mm	118mm	3000K 	1 / 20 / 100	11,95 €
10111	10w	1120	27mm	118mm	4000K 	1 / 20 / 100	11,95 €
10115	10w	1150	27mm	118mm	6000K 	1 / 20 / 100	11,95 €

LINEAL Smd Dimmable 8W

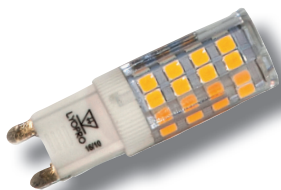



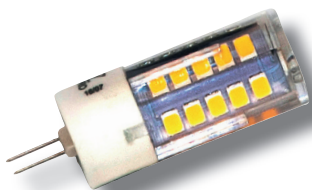

Código Code Code	W	Lumens	Ø	Altura Height Hauteur	Color Color Couleur		PVP
10134	8w	830	22mm	118mm	3000K 	1 / 20 / 100	29,95 €
10133	8w	840	22mm	118mm	4000K 	1 / 20 / 100	29,95 €
10135	8w	850	22mm	118mm	6000K 	1 / 20 / 100	29,95 €

Lámpara G9 Smd 4W

Código Code Code	W	Lumens	Ø	Altura Height Hauteur	Color Color Couleur		PVP
10136	4w	380	16,5mm	50mm	3000K 	1 / 100 / 500	7,95 €
10030	4w	390	16,5mm	50mm	4000K 	1 / 100 / 500	7,95 €
10137	4w	400	16,5mm	50mm	6000K 	1 / 100 / 500	7,95 €



Lámpara G4 Smd 3W

Código Code Code	W	Lumens	Ø	Altura Height Hauteur	Color Color Couleur		PVP
10138	3w	280	15mm	44mm	3000K 	1 / 100 / 500	8,45 €
10031	3w	290	15mm	44mm	4000K 	1 / 100 / 500	8,45 €
10139	3w	300	15mm	44mm	6000K 	1 / 100 / 500	8,45 €



QR - 111 SIGMA G53 Smd



Código Code Code	W	Lumens	Ø	Altura Height Hauteur	Color Color Couleur		PVP
10200	15w	1080	111mm	58mm	3000K 	1 / 50	29,95 €
10201	15w	1100	111mm	58mm	4000K 	1 / 50	29,95 €



QR - 111 SIGMA GU-10 Smd



Código Code Code	W	Lumens	Ø	Altura Height Hauteur	Color Color Couleur		PVP
10203	15w	1280	111mm	58mm	3000K 	1 / 50	25,95 €
10204	15w	1300	111mm	58mm	4000K 	1 / 50	25,95 €

QR - 111 SIGMA Gu-10 Smd Dimmable



Código Code Code	W	Lumens	Ø	Altura Height Hauteur	Color Color Couleur		PVP
10206	15w	1080	111mm	58mm	3000K 	1 / 50	34,95 €
10207	15w	1100	111mm	58mm	4000K 	1 / 50	34,95 €

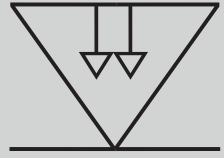

LYOPRO

Identity



LUMINARIAS GU-10
GU-10 LUMINAIRES
LUMINAIRES GU-10

Aros CORAL Empotar



R

Redondo
Round
Rond



C

Cuadrado
Square
Carrè

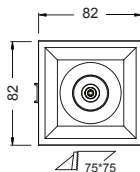
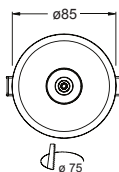

Available in October 23

recommended lamp
dichroic Smd 7.5w not included



Gu-10 included

Código Code Code	Ø Exterior Outer Ø Ø Extérieur	Corte Court Rechercher	Altura Height Hauteur	Versión Version Version	Acabado Finish Finition	PVP
12430	85mm	75mm	35mm	R	Blanco/White/Blanc	6,30 €
12431	85mm	75mm	35mm	R	Negro/Black/Noir	6,30 €
12436	82X82mm	75mm	35mm	C	Blanco/White/Blanc	6,30 €
12437	82X82mm	75mm	35mm	C	Negro/Black/Noir	6,30 €

Aros CORAL Asimetricos Empotar



RA

Redondo Asimétrico
Asymetrical Round
Rond Asymetrique



CA

Cuadrado Asimétrico
Asymetrical Square
Carrè Asymètrique

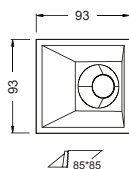
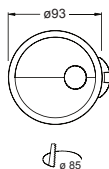

Available in October 23

recommended lamp
dichroic Smd 7.5w not included



Gu-10 included

Código Code Code	Ø Exterior Outer Ø Ø Extérieur	Corte Court Rechercher	Altura Height Hauteur	Versión Version Version	Acabado Finish Finition	PVP
12442	93mm	85mm	70mm	RA	Blanco/White/Blanc	6,95 €
12443	93mm	85mm	70mm	RA	Negro/Black/Noir	6,95 €
12448	93X93mm	85mm	70mm	CA	Blanco/White/Blanc	6,95 €
12449	93X93mm	85mm	70mm	CA	Negro/Black/Noir	6,95 €

Downlight Superficie MOON Gu-10 IP20

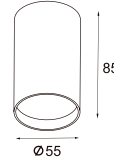

Available in November 23

recommended lamp
dichroic Smd 7.5w not included



Gu-10 included

Código Code Code	Material Material Matériel	Acabado Finish Finition	PVP
12300	Aluminio	Blanco/White/Blanc	17,95 €
12301	Aluminio	Negro/Black/Noir	17,95 €

Proyector Superficie MOON Gu-10 IP20

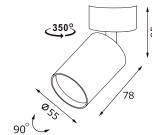

Available in November 23

recommended lamp
dichroic Smd 7.5w not included



Gu-10 included

Código Code Code	Material Material Matériel	Acabado Finish Finition	PVP
12310	Aluminio	Blanco/White/Blanc	24,95 €
12311	Aluminio	Negro/Black/Noir	24,95 €

Proyector Empotrar MOON Gu-10 IP20

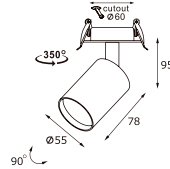

Available in November 23

recommended lamp
dichroic Smd 7.5w not included



Gu-10 included

Código Code Code	Material Material Matériel	Acabado Finish Finition	PVP
12320	Aluminio	Blanco/White/Blanc	22,95 €
12321	Aluminio	Negro/Black/Noir	22,95 €

Proyector Carril Trifásico MOON Gu-10 IP20

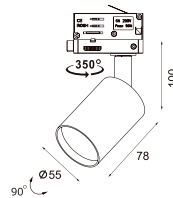

Available in November 23

recommended lamp
dichroic Smd 7.5w not included



Gu-10 included

Código Code Code	Material Material Matériel	Acabado Finish Finition	PVP
12330	Aluminio	Blanco/White/Blanc	29,95 €
12331	Aluminio	Negro/Black/Noir	29,95 €

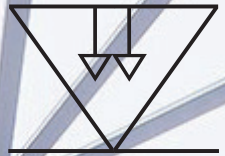

LYOPRO
Identity

DOWNLIGHTS LED
LED DOWNLIGHTS
DOWNLIGHTS LED

Downlights ATLAS Redondo Empotar Smd



Interruptor 3 CCT Switch
Switch 3 CCT Switch
Commutateur 3 Commutateur CCT

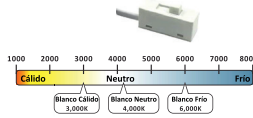

Available in November 23



Código Code Code	W	Lumens	Corte Court Rechercher	Ø Exterior Outer Ø Ø Extérieur	Color Color Couleur	Acabado Finish Finition	Electrónica Electronics Électronique	PVP
12400	6w	660	75mm	90mm	3CCT	Blanco/White/Blanc	On/Off	9,95 €
12400A	6w	660	75mm	90mm	3CCT	Blanco/White/Blanc	Triac	22,95€
12400B	6w	660	75mm	90mm	3CCT	Blanco/White/Blanc	1-10v	26,95€
12400C	6w	660	75mm	90mm	3CCT	Blanco/White/Blanc	Dali/Push	40,95€
12401	9w	990	105mm	120mm	3CCT	Blanco/White/Blanc	On/Off	10,95€
12401A	9w	990	105mm	120mm	3CCT	Blanco/White/Blanc	Triac	25,95€
12401B	9w	990	105mm	120mm	3CCT	Blanco/White/Blanc	1-10v	29,95€
12401C	9w	990	105mm	120mm	3CCT	Blanco/White/Blanc	Dali/Push	46,95€
12402	12w	1320	125mm	140mm	3CCT	Blanco/White/Blanc	On/Off	14,95€
12402A	12w	1320	125mm	140mm	3CCT	Blanco/White/Blanc	Triac	29,95€
12402B	12w	1320	125mm	140mm	3CCT	Blanco/White/Blanc	1-10v	32,95€
12402C	12w	1320	125mm	140mm	3CCT	Blanco/White/Blanc	Dali/Push	49,95€
12403	15w	1650	155mm	170mm	3CCT	Blanco/White/Blanc	On/Off	19,95€
12403A	15w	1650	155mm	170mm	3CCT	Blanco/White/Blanc	Triac	37,95€
12403B	15w	1650	155mm	170mm	3CCT	Blanco/White/Blanc	1-10v	39,95€
12403C	15w	1650	155mm	170mm	3CCT	Blanco/White/Blanc	Dali/Push	52,95€
12404	20w	2200	200mm	220mm	3CCT	Blanco/White/Blanc	On/Off	23,95€
12404A	20w	2200	200mm	220mm	3CCT	Blanco/White/Blanc	Triac	39,95€
12404B	20w	2200	200mm	220mm	3CCT	Blanco/White/Blanc	1-10v	41,95€
12404C	20w	2200	200mm	220mm	3CCT	Blanco/White/Blanc	Dali/Push	55,95€

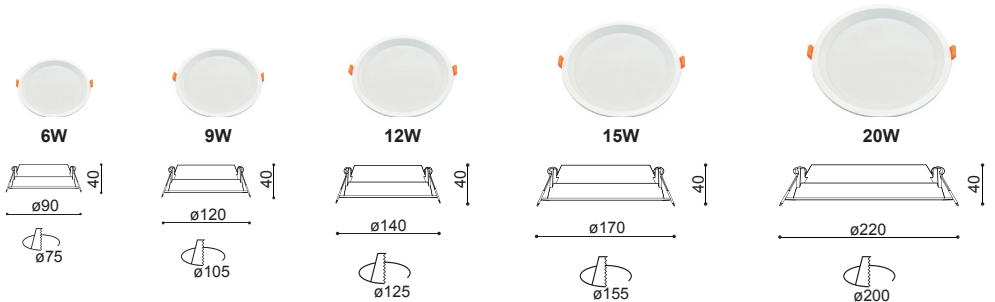

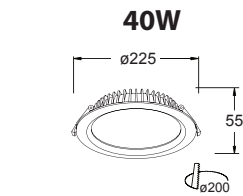
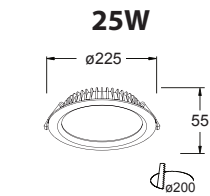
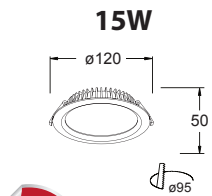
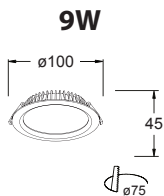
Downlights HAMMER Smd

Código Code Code	W	Lumens	Corte Court Rechercher	Ø Exterior Outer Ø Ø Extérieur	Color Color Couleur	Acabado Finish Finition	PVP
10882	9w	720	75mm	100mm	4000K □	Blanco/White/Blanc	9,95 €
10886	15w	1200	95mm	120mm	4000K □	Blanco/White/Blanc	12,95 €
10890	25w	2000	200mm	225mm	4000K □	Blanco/White/Blanc	24,95 €
10894	40w	3200	200mm	225mm	4000K □	Blanco/White/Blanc	34,95 €

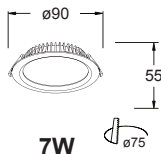
Downlights ORIÓN Cob 7W Abatible

Código Code Code	W	Lumens	Corte Court Rechercher	Ø Exterior Outer Ø Ø Extérieur	Color Color Couleur	Acabado Finish Finition	PVP
10082	7w	520	75mm	90mm	3000K ■	Blanco/White/Blanc	12,95 €
10083	7w	540	75mm	90mm	4000K □	Blanco/White/Blanc	12,95 €
10084	7w	560	75mm	90mm	6000K ■	Blanco/White/Blanc	12,95 €

Downlight LEO Redondo de Superficie Smd



Interruptor 3 CCT Switch
Switch 3 CCT Switch
Commutateur 3 Commutateur CCT

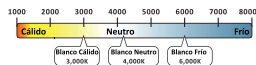

Available in December 23



Código Code Code	W	Lumens	Ø	Altura Height Hauteur	Color Color Couleur	Acabado Finish Finition	PVP
12410	6w	600	90mm	23mm	3 CCT	Blanco/White/Blanc	19,95 €
12411	12w	1200	140mm	23mm	3 CCT	Blanco/White/Blanc	25,95 €
12412	18w	1800	190mm	23mm	3 CCT	Blanco/White/Blanc	34,95 €

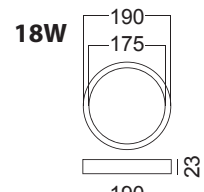
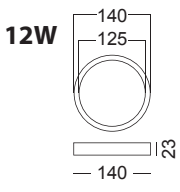
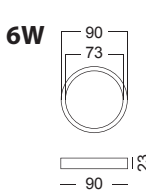

Downlight LEO Cuadrado de Superficie Smd



Interruptor 3 CCT Switch
Switch 3 CCT Switch
Commutateur 3 Commutateur CCT

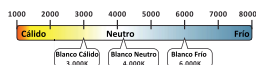

Available in December 23



Código Code Code	W	Lumens	□	Altura Height Hauteur	Color Color Couleur	Acabado Finish Finition	PVP
12420	6w	600	90x90mm	23mm	3 CCT	Blanco/White/Blanc	19,95 €
12421	12w	1200	140x140mm	23mm	3 CCT	Blanco/White/Blanc	25,95 €
12422	18w	1800	190x190mm	23mm	3 CCT	Blanco/White/Blanc	34,95 €

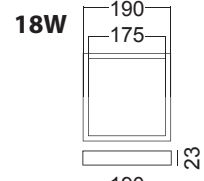
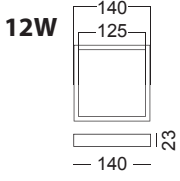
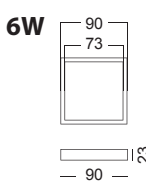

Downlights Imantado ZEUS Empotrar/Superficie 18W



Interrupción 3 CCT Switch
Switch 3 CCT Switch
Commutateur 3 Commutateur CCT

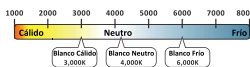

P.F. 0.97	1 / 20	NOT DIMMABLE	IP 20	30000h	On/Off 100000	120°	230v	R _a ≥80
-----------	--------	--------------	-------	--------	---------------	------	------	--------------------

Código Code Code	W	Lumens	Corte Court Rechercher	Ø Exterior Outer Ø Ø Extérieur	Color Color Couleur	Acabado Finish Finition	PVP
10853	18W	1700	55-200	217mm	3CCT	Blanco/White/Blanc	44,95 €

Aro Aluminio Downlight ZEUS



10872
Níquel/Nickel/Nickel
9,90€



10873
Cromo/Chrome/Chrome
9,90€



10874
Negro/Black/Noir
9,90€



Acabado de los Aros/ Finishing of the Rings/ Finition des anneaux

Diferentes aros de color fáciles de quitar y cambiar
Different color rings easy to remove and change
Anneaux de différentes couleurs faciles à enlever et à changer



1 2 3

Fácil instalación
Easy installation
Installation facile

ZEUS 18W

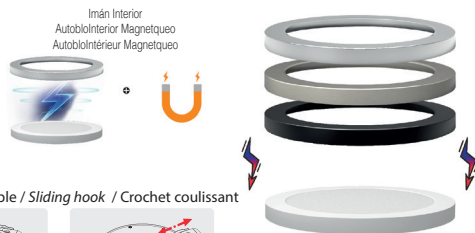

Soporte ajustable
adjustable stand
Support réglable

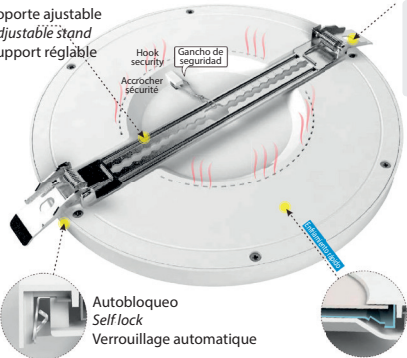

Gancho deslizable / Sliding hook / Crochet coulissant

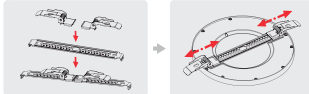

- Fácil de ajustar. / Easy to adjust. / Facile à régler.
- Diametro de corte ajustable./Adjustable cutting diameter./Diamètre de coupe réglable.
- Disipador de calor. / Heat sink. / Dissipateur thermique.
- Extrafino 15mm. / Extra fine 15mm. / Extra fin 15 mm.
- Chip Samsung. / Camsung chip. / Puce samsung.

Autobloqueo
Self lock
Verrouillage automatique

Disipador de calor integrado
Integrated heat sink
Dissipateur de chaleur intégré

Panel BACKLIT

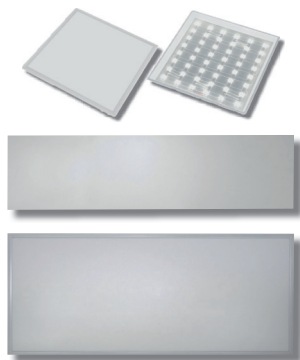

Código Code	W	Lumens	Medidas Mesures	Color Couleur	Acabado Finish	Electrónica Electronique	PVP
20240	36w	3600	600x600mm	4000K □	Blanco/White/Blanc	On/Off	39,95 €
20241	36w	3700	600x600mm	6000K ■	Blanco/White/Blanc	On/Off	39,95 €
20242	36w	3600	1200x300mm	4000K □	Blanco/White/Blanc	On/Off	49,95€
20243	36w	3700	1200x300mm	6000K ■	Blanco/White/Blanc	On/Off	49,95€
20244	72w	7200	1200x600mm	4000K □	Blanco/White/Blanc	On/Off	119,95€
20245	72w	7300	1200x600mm	6000K ■	Blanco/White/Blanc	On/Off	119,95€
20240A	36w	3600	600x600mm	4000K □	Blanco/White/Blanc	Triac	59,95€
20241A	36w	3700	600x600mm	6000K ■	Blanco/White/Blanc	Triac	59,95€
20242A	36w	3600	1200x300mm	4000K □	Blanco/White/Blanc	Triac	69,95€
20243A	36w	3700	1200x300mm	6000K ■	Blanco/White/Blanc	Triac	69,95€
20244A	72w	7200	1200x600mm	4000K □	Blanco/White/Blanc	Triac	139,95€
20245A	72w	7300	1200x600mm	6000K ■	Blanco/White/Blanc	Triac	139,95€
20240B	36w	3600	600x600mm	4000K □	Blanco/White/Blanc	1-10v	62,95€
20241B	36w	3700	600x600mm	6000K ■	Blanco/White/Blanc	1-10v	62,95€
20242B	36w	3600	1200x300mm	4000K □	Blanco/White/Blanc	1-10v	72,95€
20243B	36w	3700	1200x300mm	6000K ■	Blanco/White/Blanc	1-10v	72,95€
20244B	72w	7200	1200x600mm	4000K □	Blanco/White/Blanc	1-10v	142,95€
20245B	72w	7300	1200x600mm	6000K ■	Blanco/White/Blanc	1-10v	142,95€
20240C	36w	3600	600x600mm	4000K □	Blanco/White/Blanc	Dali/Push	82,95€
20241C	36w	3700	600x600mm	6000K ■	Blanco/White/Blanc	Dali/Push	82,95€
20242C	36w	3600	1200x300mm	4000K □	Blanco/White/Blanc	Dali/Push	92,95€
20243C	36w	3700	1200x300mm	6000K ■	Blanco/White/Blanc	Dali/Push	92,95€
20244C	72w	7200	1200x600mm	4000K □	Blanco/White/Blanc	Dali/Push	172,95€
20245C	72w	7300	1200x600mm	6000K ■	Blanco/White/Blanc	Dali/Push	172,95€

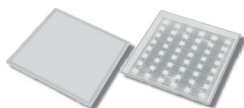
Panel BACKLIT UGR<19

Código Code Code	W	Lumens	Medidas Measures Mesures	Color Color Couleur	Acabado Finish Finition	Electrónica Electronics Électronique	PVP
20340	36w	3600	600x600mm	4000K □	Blanco/White/Blanc	On/Off	49,95€
20342	36w	3600	1200x300mm	4000K □	Blanco/White/Blanc	On/Off	59,95€
20344	72w	7200	1200x600mm	4000K □	Blanco/White/Blanc	On/Off	129,95€
20340A	36w	3600	600x600mm	4000K □	Blanco/White/Blanc	Triac	69,95€
20342A	36w	3600	1200x300mm	4000K □	Blanco/White/Blanc	Triac	79,95€
20344A	72w	7200	1200x600mm	4000K □	Blanco/White/Blanc	Triac	149,95€
20340B	36w	3600	600x600mm	4000K □	Blanco/White/Blanc	1-10v	72,95€
20342B	36w	3600	1200x300mm	4000K □	Blanco/White/Blanc	1-10v	82,95€
20344B	72w	7200	1200x600mm	4000K □	Blanco/White/Blanc	1-10v	152,95€
20340C	36w	3600	600x600mm	4000K □	Blanco/White/Blanc	Dali/Push	92,95€
20342C	36w	3600	1200x300mm	4000K □	Blanco/White/Blanc	Dali/Push	102,95€
20344C	72w	7200	1200x600mm	4000K □	Blanco/White/Blanc	Dali/Push	182,95€

Marco de Empotrar Panel SITARA



Código Code Code	Medidas de Corte Cutting Measures Mesures de coupe		PVP
20146 Marco para Panel Led 60x60	607x607mm	1 / 12	19,95 €
20147 Marco para Panel Led 120x30	1210x312mm	1 / 12	24,95 €
20148 Marco para Panel Led 120x60	1205x610mm	1 / 12	32,95 €



LYOPRO

Identity

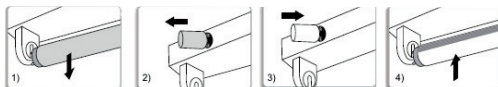
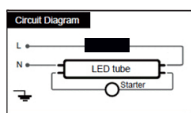
INDUSTRIAL
INDUSTRIAL
INDUSTRIEL

Tube PC T-8 Smd

- 1) Retirar tubo fluorescente convencional. 2) Quitar cebador.
3) Poner nuevo cebador led puenteado. 4) Colocar tubo led.



Código Code Code	W	Lumens	Ø	Longitud Length Longueur	Color Color Couleur	Acabado Finish Finition	PVP
10093	10w	970	32mm	600mm	4000K □	Opal	7,85 €
10094	18w	1750	32mm	1200mm	4000K □	Opal	10,99 €
10095	24w	2300	32mm	1500mm	4000K □	Opal	14,65 €

Tube T-8 Cristal

Código Code Code	W	Lumens	Ø	Longitud Length Longueur	Color Color Couleur	Acabado Finish Finition	PVP
10184	10w	950	32mm	600mm	3000K ■	Opal	4,95 €
10185	14w	1330	32mm	900mm	3000K ■	Opal	6,40 €
10186	18w	1720	32mm	1200mm	3000K ■	Opal	6,70 €
10187	24w	2250	32mm	1500mm	3000K ■	Opal	8,95 €
10193	10w	970	32mm	600mm	4000K □	Opal	4,95 €
10197	14w	1350	32mm	900mm	4000K □	Opal	6,40 €
10194	18w	1750	32mm	1200mm	4000K □	Opal	6,70 €
10195	24w	2300	32mm	1500mm	4000K □	Opal	8,95 €
10190	10w	990	32mm	600mm	6000K ■	Opal	4,95 €
10196	14w	1370	32mm	900mm	6000K ■	Opal	6,40 €
10191	18w	1780	32mm	1200mm	6000K ■	Opal	6,70 €
10192	24w	2350	32mm	1500mm	6000K ■	Opal	8,95 €
10198	Starter						0,65 €

Tubo Cristal CARNICERIAS



Código Code Code	W	Lumens	Ø	Longitud Length Longueur	Acabado Finish Finition	PVP
10180	9w	890	32mm	600mm	Opal	17,95 €
10181	12w	1190	32mm	900mm	Opal	22,55 €
10182	18w	1780	32mm	1200mm	Opal	28,25 €
10183	22w	2180	32mm	1500mm	Opal	33,90 €



Led Starter



Código Code Code		PVP
10198	1 / 25	0,65 €

Regleta ZOE



Código Code Code	W	Lumens	Medidas Measures Mesures	Color Color Couleur	Equivalencia Equivalence Équivalence	PVP
10511	9w	790	300x75x22mm	4000K □	1 Tubo de 60cm	11,95 €
10512	9w	810	300x75x22mm	6000K ■	1 Tubo de 60cm	11,95 €
10514	18w	1600	600x75x22mm	4000K □	2 Tubos de 60cm	16,95 €
10253	18w	1620	600x75x22mm	6000K ■	2 Tubos de 60cm	16,95 €
10516	36w	3200	1200x75x22mm	4000K □	2 Tubos de 120cm	29,95 €
10254	36w	3240	1200x75x22mm	6000K ■	2 Tubos de 120cm	29,95 €

Pantalla Estanca DORIS



Available in November 23

FAST CONNECTOR



25W



50W



60W



Código Code Code	W	Lumens	Medidas Measures Mesures	Color Color Couleur		Material Material Matériel	PVP
12470	25w	2500	568x70x55	4000K□	1 / 12	Abs + Pc	33,95 €
12471	50w	5000	1168x70x55	4000K□	1 / 12	Abs + Pc	47,95 €
12472	60w	6000	1468x70x55	4000K□	1 / 12	Abs + Pc	63,95 €



Pantalla Estanca para tubo led



IP
65

Código Code Code	Material Material Matériel	Longitud Length Longueur	Ancho Width Large	Altura Height Hauteur		PVP
10500	ABS/PC	660	70mm	80mm	1 / 18	12,95 €
10501	ABS/PC	1260	70mm	80mm	1 / 12	19,95 €
10502	ABS/PC	1570	70mm	80mm	1 / 12	28,95 €
10503	ABS/PC	660	110mm	94mm	1 / 10	17,95 €
10504	ABS/PC	1260	110mm	94mm	1 / 8	24,95 €
10505	ABS/PC	1570	110mm	94mm	1 / 8	32,95 €

Regleta abierta



IP
20

Código Code Code	Material Material Matériel	Longitud Length Longueur	Ancho Width Large	Altura Height Hauteur		PVP
10506	Acero	623mm	50mm	37mm	1 / 10	11,20 €
10507	Acero	1235mm	50mm	37mm	1 / 10	14,65 €
10508	Acero	1532mm	50mm	37mm	1 / 10	21,45 €
10540	Acero	623mm	90mm	37mm	1 / 6	14,65 €
10541	Acero	1235mm	90mm	37mm	1 / 6	19,20 €
10542	Acero	1532mm	90mm	37mm	1 / 6	22,55 €

Bombilla LINE Smd



P.F. 0.97	 1 / 20	 NOT DIMMABLE	IP 20	 30000h
On/Off 100000	 330°	 230v	R _a ≥80	 E 27

Código Code Code	W	Lumens	Medidas Measures Mesures	Color Color Couleur	Equivalencia Equivalence Équivalence	PVP
10471	30w	2660	96x228mm	4000K <input type="checkbox"/>	HQI. 70w	29,95 €
10472	30w	2700	96x228mm	6000K <input checked="" type="checkbox"/>	HQI. 70w	29,95 €
10474	40w	3550	108x264mm	4000K <input type="checkbox"/>	HQI. 100w	36,95 €
10475	40w	3600	108x264mm	6000K <input checked="" type="checkbox"/>	HQI. 100w	36,95 €
10477	50w	4900	108x264mm	4000K <input type="checkbox"/>	HQI. 120w	42,95 €
10478	50w	5000	108x264mm	6000K <input checked="" type="checkbox"/>	HQI. 120w	42,95 €
10976	Adaptador E-40 / E-40 Adapter / Adaptateur E-40					1,25 €



LYOPRO
Identity



APLIQUES LED
LED SCONCES
BULKHEAD LED

Aplicque Estanco GAMMA Redondo 10W



Código Code	W	Lumens	Ø	Altura Height Hauteur	Color Color Couleur	Acabado Finish Finition	PVP
11271	10w	700	170mm	70mm	4000K□	Blanco/White/Blanc	16,95 €

Aplicque Estanco GAMMA Ovalado 10W



Código Code	W	Lumens	Ancho x Largo Width x Length Largeur x Longueur	Altura Height Hauteur	Color Color Couleur	Acabado Finish Finition	PVP
11274	10w	700	169x116mm	70mm	4000K□	Blanco/White/Blanc	16,95 €

Aplicque Estanco COSMOS 14W Oval



Código Code	W	Lumens	Medidas Measures Mesures	Color Color Couleur	Acabado Finish Finition	PVP
11277	14w	1000	212x119x60,5mm	4000K□	Negro/Black/Noir	19,95 €
11292	14w	1000	212x119x60,5mm	4000K□	Blanco/White/Blanc	19,95 €

Aplicque Estanco COSMOS 14W Redondo



Código Code	W	Lumens	Ø	Altura Height Hauteur	Color Color Couleur	Acabado Finish Finition	PVP
11283	14w	1000	215mm	80mm	4000K□	Negro/Black/Noir	24,95 €
11298	14w	1000	215mm	80mm	4000K□	Blanco/White/Blanc	24,95 €

Aplicue Estanco COSMOS Redondo Media Luna 14W

Código Code Code	W	Lumens	Ø	Altura Height Hauteur	Color Color Couleur	Acabado Finish Finition	PVP
11289	14w	1000	215mm	80mm	4000K <input type="checkbox"/>	Negro/Black/Noir	26,95 €
11304	14w	1000	215mm	80mm	4000K <input type="checkbox"/>	Blanco/White/Blanc	26,95 €

Aplicue Estanco COSMOS Ovalado con Sensor de Movimiento 14W

Especificaciones sensor / Sensor specifications / Spécifications du capteur

Angulo detección 120° / *Detection angle 120°* / Angle de détection 120°

Distancia de detección 8-10 metros / *Detection distance 8-10 meters* / Distance de détection 8-10 mètres

Tiempo de encendido 10 segundos a 5 minutos ajustable / *On time 10 seconds to 5 minutes adjustable* / A l'heure 10 secondes à 5 minutes réglable



Código Code Code	W	Lumens	Medidas Measures Mesures	Color Color Couleur	Acabado Finish Finition	PVP
11280	14w	1000	212x119x60,5mm	4000K <input type="checkbox"/>	Negro/Black/Noir	39,95 €
11295	14w	1000	212x119x60,5mm	4000K <input type="checkbox"/>	Blanco/White/Blanc	39,95 €

Aplicue Estanco COSMOS Redondo con Sensor de Movimiento 14W

Especificaciones sensor / Sensor specifications / Spécifications du capteur

Angulo detección 120° / *Detection angle 120°* / Angle de détection 120°

Distancia de detección 8-10 metros / *Detection distance 8-10 meters* / Distance de détection 8-10 mètres

Tiempo de encendido 10 segundos a 5 minutos ajustable / *On time 10 seconds to 5 minutes adjustable* / A l'heure 10 secondes à 5 minutes réglable



Código Code Code	W	Lumens	Ø	Altura Height Hauteur	Color Color Couleur	Acabado Finish Finition	PVP
11286	14w	1000	215mm	80mm	4000K <input type="checkbox"/>	Negro/Black/Noir	44,95 €
11301	14w	1000	215mm	80mm	4000K <input type="checkbox"/>	Blanco/White/Blanc	44,95 €

























LYOPRO
Identity



PROYECTORES LED
LED FLOODLIGHTS
PROJECTEURS LED

Projector STAR Smd

Código Code Code	W	Lumens	Medidas Measures Mesures	Color Color Couleur		PVP
15400	10w	860	104x125x27mm	3000K 	1 / 36	13,45 €
15401	10w	880	104x125x27mm	4000K 	1 / 36	13,45 €
15402	10w	900	104x125x27mm	6000K 	1 / 36	13,45 €
15403	20w	1760	125x152x27mm	3000K 	1 / 30	21,95 €
15404	20w	1780	125x152x27mm	4000K 	1 / 30	21,95 €
15405	20w	1800	125x152x27mm	6000K 	1 / 30	21,95 €
15406	30w	2660	168x209x27mm	3000K 	1 / 20	32,95 €
15407	30w	2680	168x209x27mm	4000K 	1 / 20	32,95 €
15408	30w	2700	168x209x27mm	6000K 	1 / 20	32,95 €
15409	50w	4460	200x237x36mm	3000K 	1 / 12	44,95 €
15410	50w	4480	200x237x36mm	4000K 	1 / 12	44,95 €
15411	50w	4500	200x237x36mm	6000K 	1 / 12	44,95 €
15412	70w	6260	282x321x38mm	3000K 	1 / 4	85,90 €
15413	70w	6280	282x321x38mm	4000K 	1 / 4	85,90 €
15414	70w	6300	282x321x38mm	6000K 	1 / 4	85,90 €
15415	100w	8960	282x321x38mm	3000K 	1 / 4	92,95 €
15416	100w	8980	282x321x38mm	4000K 	1 / 4	92,95 €
15417	100w	9000	282x321x38mm	6000K 	1 / 4	92,95 €
15419	150w	13480	333x420x51mm	4000K 	1 / 3	159,95 €
15420	150w	13500	333x420x51mm	6000K 	1 / 3	159,95 €
15422	200w	17980	385x470x51mm	4000K 	1 / 2	225,75 €
15423	200w	18000	385x470x51mm	6000K 	1 / 2	225,75 €

Projector **DIAMOND Smd**



30W



50W



80W



100W















150W



200W



Código Code Code	W	Lumens	Medidas Measures Mesures	Color Color Couleur		PVP
15004	30w	2660	175x214x77mm	3000K 	1 / 16	42,75 €
15020	30w	2680	175x214x77mm	4000K 	1 / 16	42,75 €
15021	50w	4480	196x241x86mm	4000K 	1 / 8	55,85 €
15007	50w	4500	196x241x86mm	6000K 	1 / 8	55,85 €
15008	80w	7160	350x252x75mm	3000K 	1 / 2	123,60 €
15022	80w	7180	350x252x75mm	4000K 	1 / 2	123,60 €
15009	80w	7200	350x252x75mm	6000K 	1 / 2	123,60 €
15010	100w	8860	350x252x75mm	3000K 	1 / 2	135,45 €
15023	100w	8880	350x252x75mm	4000K 	1 / 2	135,45 €
15025	150w	13980	487x271x77mm	4000K 	1 / 3	213,95 €
15012	150w	14000	487x271x77mm	6000K 	1 / 3	213,95 €
15027	200w	17980	537x411x81mm	4000K 	1 / 2	279,55 €
15013	200w	18000	537x411x81mm	6000K 	1 / 2	279,55 €



Proyector BETTER Smd

10W

20W

30W

50W

Código Code Code	W	Lumens	Medidas Measures Mesures	Color Color Couleur		Acabado Finish Finition	PVP
15200	10w	860	101x125x28,5mm	3000K 	1 / 30	Blanco/White/Blanc	16,90 €
15210	10w	880	101x125x28,5mm	4000K 	1 / 30	Blanco/White/Blanc	16,90 €
15201	10w	900	101x125x28,5mm	6000K 	1 / 30	Blanco/White/Blanc	16,90 €
15202	20w	1760	129x151x29,5mm	3000K 	1 / 20	Blanco/White/Blanc	28,20 €
15211	20w	1780	129x151x29,5mm	4000K 	1 / 20	Blanco/White/Blanc	28,20 €
15203	20w	1800	129x151x29,5mm	6000K 	1 / 20	Blanco/White/Blanc	28,20 €
15204	30w	2660	163x186x34mm	3000K 	1 / 12	Blanco/White/Blanc	41,75 €
15212	30w	2680	163x186x34mm	4000K 	1 / 12	Blanco/White/Blanc	41,75 €
15205	30w	2700	163x186x34mm	6000K 	1 / 12	Blanco/White/Blanc	41,75 €
15206	50w	4460	193x227x37mm	3000K 	1 / 8	Blanco/White/Blanc	56,45 €
15213	50w	4480	193x227x37mm	4000K 	1 / 8	Blanco/White/Blanc	56,45 €
15207	50w	4500	193x227x37mm	6000K 	1 / 8	Blanco/White/Blanc	56,45 €



Proyector BETTER Smd con Sensor de Movimiento 20W

Especificaciones sensor / Sensor specifications / Spécifications du capteur

 Angulo detección 120° / *Detection angle 120°* / Angle de détection 120°

 Distancia de detección 8-10 metros / *Detection distance 8-10 meters* / Distance de détection 8-10 mètres

 Tiempo de encendido 10 segundos a 5 minutos ajustable / *On time 10 seconds to 5 minutes adjustable* / A l'heure 10 secondes à 5 minutes réglable

Código Code Code	W	Lumens	Medidas Measures Mesures	Color Color Couleur		Acabado Finish Finition	PVP
15219	20w	1760	129x183x57mm	3000K 	1 / 20	Blanco/White/Blanc	51,95 €
15220	20w	1780	129x183x57mm	4000K 	1 / 20	Blanco/White/Blanc	51,95 €

Projector STAR Smd Ccon Sensor de Movimiento y Crepuscular



Especificaciones sensor / Sensor specifications / Spécifications du capteur

Angulo de detección 120° / Detection angle 120° / Angle de détection 120°
 Distancia de detección 8-10 metros / Detection distance 8-10 meters / Distance de détection 8-10 mètres
 Tiempo de encendido 10 segundos a 5 minutos ajustable / On time 10 seconds to 5 minutes adjustable / A l'heure 10 secondes à 5 minutes réglable



Código Code Code	W	Lumens	Medidas Measures Mesures	Color Color Couleur		Acabado Finish Finition	PVP
15429	30w	2460	168x252x54mm	3000K	1 / 20	Negro/Black/Noir	64,95 €
15430	30w	2480	168x252x54mm	4000K	1 / 20	Negro/Black/Noir	64,95 €
10079	30w	2500	168x252x54mm	6000K	1 / 20	Negro/Black/Noir	64,95 €
15432	50w	4460	200x287x57mm	3000K	1 / 12	Negro/Black/Noir	69,95 €
15433	50w	4480	200x287x57mm	4000K	1 / 12	Negro/Black/Noir	69,95 €
15434	50w	4500	200x287x57mm	6000K	1 / 12	Negro/Black/Noir	69,95 €

Projector STAR Smd RGB 50W



Mando RGB incluido
 RGB controller included
 Contrôleur RVB inclus



Código Code Code	W	Lumens	Medidas Measures Mesures	Color Color Couleur		Acabado Finish Finition	PVP
15447	50w	4500	200x237x36mm	RGB	1 / 12	Negro/Black/Noir	69,95 €

Projector Recargable Smd 10W















Sin driver, funciona con batería recargable. / Without driver, it works with rechargeable battery.
 / Sans pilote, il fonctionne avec une batterie rechargeable.

- Tiempo de carga: 4 horas. / - Charging time: 4 hours. / - Temps de charge : 4 heures.
 - Tiempo descarga: 3 horas. / - Charging time: 3 hours. / - Temps de charge : 3 heures.















Código Code Code	W	Lumens	Medidas Measures Mesures	Color Color Couleur		Acabado Finish Finition	PVP
10069	10w	900	147x162x240mm	6000K	1 / 10	Negro/Black/Noir	68,95 €

Proyector Smd con Tripode 5mts Cable

Código Code Code	W	Lumens	Color Color Couleur	PVP
15350	10w	800	3000K 	89,95 €
15351	10w	860	4000K 	89,95 €
15352	10w	900	6000K 	89,95 €
15353	20w	1700	3000K 	94,95 €
15354	20w	1760	4000K 	94,95 €
15355	20w	1800	6000K 	94,95 €
15356	30w	2600	3000K 	109,95 €
15357	30w	2660	4000K 	109,95 €
15358	30w	2700	6000K 	109,95 €
15359	50w	4400	3000K 	119,95 €
15360	50w	4460	4000K 	119,95 €
15361	50w	4500	6000K 	119,95 €





P.F. 0.95	 NOT DIMMABLE	IP 65	 30000h
On/Off 100000	 120°	 230v	 Ra ≥80



































Proyector Doble Smd on Tripode 5mts Cable

Código Code Code	W	Lumens	Color Color Couleur	PVP
15362	2x10w	1600	3000K 	124,95 €
15363	2x10w	1720	4000K 	124,95 €
15364	2x10w	1800	6000K 	124,95 €
15365	2x20w	3400	3000K 	132,95 €
15366	2x20w	3520	4000K 	132,95 €
15367	2x20w	3600	6000K 	132,95 €
15368	2x30w	5200	3000K 	144,95 €
15369	2x30w	5320	4000K 	144,95 €
15370	2x30w	5400	6000K 	144,95 €
15371	2x50w	8800	3000K 	164,95 €
15372	2x50w	8920	4000K 	164,95 €
15373	2x50w	9000	6000K 	164,95 €

P.F. 0.95	 NOT DIMMABLE	IP 65	 30000h
On/Off 100000	 120°	 230v	 Ra ≥80

Accesorios

Código Code Code	Referencia Reference Référence	PVP
 10951	Portalámparas GU-10 / <i>GU-10 lamp holder</i> / Douille GU-10	0,50 €
 10954	Conector rápido IP68 / <i>IP68 quick connector</i> / Connecteur rapide IP68	9,95 €
 10955	Conector rápido en T IP68 / <i>Quick connector in T IP68</i> / Connecteur rapide en T IP68	19,95€
 10976	Convertidor E-27 a E-40 / <i>E-27 to E-40 Converter</i> / Convertisseur E-27 à E-40	1,25 €

	Casquillo GU-10		Casquillo G-9
	Casquillo MR-16		Índice de reproducción cromática
	Casquillo MR-11		Factor de potencia
	Casquillo G-53		Unidad de embalaje master
	Casquillo R7S		Grado de protección, contra los impactos mecánicos nocivos
	Equivalencia a led		Sensor de movimiento
	No permite regulación de flujo luminoso		Celula crepuscular
	Permite regulación de flujo luminoso		Corte circular
	Grado de protección, contra polvo y humedad		Corte rectangular
	Vida media útil		Protector de sobretensión
	Funciona a 12V		Chip led Samsung
	Ciclos de encendido y apagado		Chip led Epistar
	Grado de apertura del haz de la luz		Chip led Sanan
	Funciona a 230V		Chip led Edisón
	Casquillo E-14		Chip led Lumileds
	Casquillo E-27		Driver Mean Well
	Casquillo E-40		Driver Lifud
	Casquillo G-4		Corte cada 10 cm. / Corte cada metro
			UGR<19
			Conforme a las directivas europeas y la norma EN 60598



GU-10 socket



MR-16 socket



MR-11 socket



G-53 socket



R7S socket



LED equivalence



Does not allow regulation
luminous flux



Allows regulation of
luminous flux



Degree of protection, against
dust and moisture



Average useful life



Works at 12V



On and off cycles



Light beam opening degree



Works at 230V



E-14 socket



E-27 socket



E-40 socket



G-4 socket



G-9 socket



Color rendering index



Power factor



Master packaging unit



Degree of protection, against
harmful mechanical impacts



Motion sensor



Twilight cell



circle cut



rectangular cut



surge protector



samsung led chip



Epistar led chip



Sanan led chip



edison led chip



led chip lumileds



Driver Mean Well



Driver Liquid





































Cut every 10 cm. / Cut every meter



UGR<19



Conforms to European directives
and the EN 60598 standard

	Prise GU-10		Prise G-9
	Prise MR-16		Indice de rendu des couleurs
	Douille MR-11		Facteur de puissance
	Casquette G-53		Unité de conditionnement maître
	Prise R7S		Degré de protection, contre impacts mécaniques nocifs
	Équivalence LED		Capteur de mouvement
	Ne permet pas la régulation flux lumineux		cellule crépusculaire
	Permet la régulation de flux lumineux		Cercle coupé
	Degré de protection, contre poussière et humidité		Coupe rectangulaire
	Durée de vie moyenne		Parasurtenseur
	Fonctionne à 12V		Ébrécher led Samsung
	Cycles marche et arrêt		Ébrécher led Epistar
	Degré d'ouverture du faisceau lumineux		Ébrécher led Sanan
	Fonctionne à 230V		Ébrécher led Edison
	Prise E-14		Ébrécher led Lumileds
	Prise E-27		Conducteurs Mean Well
	Prise E-40		Conducteurs Lifud
	Prise G-4		Couper tous les 10 cm. / Couper chaque mètre
			UGR<19
			Conforme aux directives européennes et la norme EN 60598

CONDICIONES GENERALES DE VENTA

FORMALIZAR UN PEDIDO IMPLICA LA ACEPTACIÓN DE ESTAS CONDICIONES DE VENTA GENERALES

Todas las ventas se realizan bajo las condiciones relacionadas a continuación. Cualquier especificación que no se ajuste a estas condiciones tendrá que ser antes aceptada por escrito por LYOPRO.

PRESUPUESTOS

Los presupuestos tendrán una validez máxima de 30 días naturales desde la fecha de su emisión.

GARANTÍA Y CALIDAD

Todos nuestros productos están garantizados (consultar en cada caso la ficha técnica en www.lyopro.es) contra cualquier defecto de fabricación. Esta garantía no cubre deterioros sufridos por el uso o aplicación indebida, incorrecta manipulación, una no correcta instalación cuando el producto haya sido usado fuera de su capacidad, maltratado, golpeado, así como cualquier otra falla atribuible al cliente o consumidor o cuando la falla sea original por el desgaste normal de las piezas debido a su funcionamiento o instalación. Queda fuera de garantía todo material manipulado por personal no autorizado por la empresa. Pequeñas diferencias entre nuestros productos en cuanto a tamaño, color, calidad o cualquier otra modificación en el producto, no serán motivo de reclamación por parte del comprador. Cualquier reclamación imputada en cuanto a cantidad, calidad u otros defectos serán comunicadas a LYOPRO, en un plazo máximo de 48 horas a la recepción de la mercancía, transcurrido este plazo no dará lugar a reclamación alguna. Para la ejecución de la garantía mediante abono o reposición es imprescindible recibir el material en cuestión para poder ser analizado y determinar que ésta procede. Requisito indispensable en toda garantía la presentación de factura y comprobante de pago y rellenando el RMA correspondiente. LYOPRO en continua mejora de la calidad y funcionalidad de sus productos se reserva el derecho a modificar o suprimir cualquiera de estos sin previo aviso sin que ello sea motivo de reclamación por parte del cliente.

PLAZO DE ENTREGA

Los plazos de entrega son sólo aproximados y sin compromiso, no admitiéndose demanda por daños y perjuicios por parte del cliente por demora de la entrega, ni otras demandas o indemnizaciones por incumplimientos contractuales. El incumplimiento del plazo de entrega no faculta al cliente a la rescisión del contrato de compra sin la concesión de un plazo prudencial de tiempo para solucionar dicha demora (importaciones de materiales y productos varios (60-90 días). Las causas de fuerza mayor (guerras, revoluciones, huelgas, catástrofes naturales, roturas de maquinaria, roturas de moldes o matrices, imposibilidad de adquisición de materia prima, interrupción del transporte, cierre de aduanas o cualquier otra medida oficial que pudiera afectar, etc.) nos da el derecho a demorar el plazo de entrega sin previo aviso. Cada operación es una expedición independiente, aunque varias de ellas formen parte de un mismo pedido.

PRECIOS / PORTES

Serán los establecidos en nuestra web a excepción de acuerdos explícitos confirmados por LYOPRO.

PORTES: Condiciones válidas únicamente en territorio peninsular español. Portes pagados a partir de 200€ y en perfiles LED PROFILE de hasta 2 metros de longitud. **Islas Canarias:** Portes pagados a partir de 600€ y en perfiles LED PROFILE de hasta 2 metros de longitud. Debido a errores de imprenta, evolución de los productos o a las constantes fluctuaciones de la materia prima, LYOPRO se reserva el derecho de variar los precios sin previo aviso. Perfiles de más de 2 metros, tendrá un coste adicional de 15 euros por expedición.

PEDIDOS

Todos los pedidos de material cortado ó manipulado deberán confirmarse por escrito (devolviendo la hoja de pedido que se pase por correo electrónico) antes de que entren en funcionamiento. Todo pedido de fabricación y manipulación que supere los 1.500 € el cliente deberá abonar el 50% por adelantado antes del inicio de la fabricación (en concepto de reserva). En todos los pedidos de materiales que no hayan sido cursados por escrito (E-mail) LYOPRO no se hace responsable si hay disconformidad con lo que pidió y se sirvió. Ningún pedido cuya forma de pago sea transferencia entrará en funcionamiento antes de recibir el resguardo del pago.

ANULACIONES-DEVOLUCIONES DE PEDIDOS

No se aceptarán devoluciones transcurridos 15 días desde la entrega de material. Los pedidos pasados en firme no pueden ser anulados sin la conformidad de LYOPRO. En caso de devolución por causas ajenas a LYOPRO, el material será abonado con un 20% de demérito (con un mínimo de 10 €). No se aceptará ninguna devolución de materiales sin la autorización expresa de LYOPRO y con la hoja de devolución cumplimentada. De igual forma no se aceptará ninguna devolución a portes debidos si el motivo de dicha devolución es error de LYOPRO será LYOPRO quien envíe su agencia). No se aceptará responsabilidad ni reclamación alguna que sobrepase la reposición del material enviado o el pago de éste al precio al que fue adquirido. Ningún producto fabricado o medida ó traído expresamente para el cliente (que no se encuentre en stock habitual) será reembolsado, no teniendo derecho el cliente a reclamación alguna. Cualquier pedido especial, hecho a medida, que lleve cortes etc..., no tendrá devolución

RESERVA DE PROPIEDAD

La mercancía suministrada queda en nuestra total propiedad hasta su pago. El derecho de propiedad subsiste aún después de que el comprador haya revendido el producto, hasta que no haya cancelado la deuda con LYOPRO.

TRANSPORTE

Cualquier anomalía del material recibido o incidencia del transporte deberá ser reflejada en el albarán que se firma al transportista o perderá el derecho a reclamación. El cliente deberá posteriormente darnos el aviso de la incidencia antes de las 24h posteriores a la entrega, no responsabilizándose en ningún caso si la reclamación es posterior a lo indicado. Es de competencia del cliente ejercer sus acciones con los transportistas en caso de pérdida, avería o retraso de la mercancía. El cliente tiene la obligación de examinar la mercancía en el momento de la entrega y anotar cualquier anomalía. No poner reparo en el talón o albarán de la agencia de transporte se entenderá que es de su conformidad. Si el cliente no ha dado instrucciones especiales de expedición, la mercancía se enviará según nuestro mejor parecer y por medio de transporte elegido por LYOPRO.

PAGO

Las condiciones de pago serán las acordadas con nuestros clientes. Los vencimientos de los pagos mediante cualquier documento de pago legalmente aceptado, deberán de respetarse puntualmente. En caso contrario estamos facultados a cargar los intereses de demora, así como los quebrantos ocasionados por la demora en el pago. Las demoras en el pago traen consigo con efecto inmediato la anulación de todos los compromisos de LYOPRO para con el cliente. El comprador no está autorizado a retener la totalidad a parte de los pagos vencidos por no haberse reconocido alguna reclamación, ya que ésta no le exime de su compromiso de pago. Todo impagado o retraso en el pago anula la posibilidad del crédito, paralizando el suministro de materiales en tanto no se regularice la situación. Si esta situación fuera repetitiva, se procederá a comunicarlo a CRÉDITO & CAUCIÓN cancelándose el crédito de forma irrevocable.

FUERO

Para cuantas cuestiones y discrepancias se deriven de la presente operación, comprador y vendedor se someten expresamente a la competencia de los jueces y tribunales de los Juzgados de Valencia con renuncia a cualquier otro fuero propio o reserva de dominio que pudiera corresponder.

COSTAS Y GASTOS

Los gastos y costas judiciales, incluso honorarios de Abogado y derechos de Procurador, serán siempre por cuenta de la parte contratante que hubiera dado lugar a ellos por incumplimiento de estas condiciones generales de venta o del contrato en general.

DERECHO SUPLETORIO

El presente contrato de venta se regirá por lo aquí convenido y en su defecto por las normas del Código de Comercio Español para las ventas en España.

LEDS Y ORDENACIÓN S.L. (LYOPRO) CIF: B98495526

C/ SEQUIA DE RASCAÑA, 14, NAVE 6, 46210. PICAÑA (VALENCIA)

GENERAL SALE CONDITIONS

FORMALIZING AN ORDER IMPLIES THE ACCEPTANCE OF THESE GENERAL CONDITIONS OF SALE

All sales are made under the conditions listed below. Any specification that does not conform to these conditions will have to be previously accepted in writing by LYOPRO.

OFFERS

Budgets will be valid for a maximum of 30 calendar days from the date of issue.

WARRANTY AND QUALITY

All our products are guaranteed (consult the technical sheet in each case at www.lyopro.es) against any manufacturing defect. This guarantee does not cover deterioration suffered by improper use or application, incorrect handling, incorrect installation when the product has been used beyond its capacity, mistreated, hit, as well as any other failure attributable to the client or consumer or when the failure is due to the normal wear and tear of the parts due to its operation or installation. Any material handled by personnel not authorized by the company is out of warranty. Small differences between our products in terms of size, color, quality or any other modification in the product will not be grounds for a claim by the buyer. Any claim made in terms of quantity, quality or other defects will be communicated to LYOPRO, within a maximum period of 48 hours upon receipt of the merchandise, after this period will not give rise to any claim. For the execution of the guarantee through payment or replacement, it is essential to receive the material in question in order to be able to analyze it and determine that it is appropriate. An essential requirement in any guarantee is the presentation of the invoice and proof of payment and filling in the corresponding RMA. LYOPRO in continuous improvement of the quality and functionality of its products reserves the right to modify or delete any of these without prior notice without this being a reason for a claim by the client.

DELIVERY TERM

Delivery times are only approximate and without obligation, not accepting claims for damages by the customer for delayed delivery, or other claims or compensation for breaches of contract. Failure to comply with the delivery period does not authorize the client to terminate the purchase contract without granting a reasonable period of time to solve said delay (imports of materials and various products (60-90 days). Force majeure (wars, revolutions, strikes, natural catastrophes, machinery breakage, mold or die breakage, impossibility of acquiring raw materials, transport interruption, customs closure or any other official measure that may affect, etc.) gives us the right to delay the delivery period without prior notice. Each operation is an independent expedition, even if several of them are part of the same order.

PRICES / SHIPPING

FREIGHT: The transport price conditions for outside Spain will be defined with the opening of each customer's file.

ORDERS

All orders for cut or manipulated material must be confirmed in writing (returning the order form sent by email) before they go into operation. Any order for manufacturing and handling that exceeds €1,500, the customer must pay 50% in advance before the start of manufacturing (as a reserve). In all requests for materials that have not been made in writing (E-mail) LYOPRO is not responsible if there is disagreement with what was requested and served. No order whose payment method is transfer will start working before receiving the receipt of payment.

CANCELLATIONS-RETURNS OF ORDERS

Returns will not be accepted after 15 days from the delivery of material. Firm orders cannot be canceled without the consent of LYOPRO.

In case of return for reasons beyond LYOPRO's control, the material will be paid with a 20% demerit (with a minimum of €10). No return of materials will be accepted without the express authorization of LYOPRO and with the completed return sheet. In the same way, no return to postage due will be accepted if the reason for said return is a LYOPRO error, LYOPRO will be the one who sends its agency). No liability or claim will be accepted that exceeds the replacement of the material sent or the payment thereof at the price at which it was purchased. No product made to measure or brought expressly for the client (that is not in regular stock) will be reimbursed, and the client is not entitled to any claim. Any special order, made to measure, that has cuts, etc., will not be refundable.

PROPERTY RESERVATION

The supplied goods remain our full property until paid for. The property right subsists even after the buyer has resold the product, until the debt with LYOPRO has been cancelled.

TRANSPORT

Any anomaly of the material received or incidence of transport must be reflected in the delivery note that is signed to the carrier or you will lose the right to claim. The client must subsequently notify us of the incident within 24 hours after delivery, not being responsible in any case if the claim is made after to the indicated It is the responsibility of the client to exercise their actions with the carriers in case of loss, breakdown or delay of the merchandise. The client has the obligation to examine the merchandise at the time of delivery and note any anomalies. Not objecting to the check or delivery note of the transport agency will be understood to be in accordance with it. If the client has not given special shipping instructions, the merchandise will be sent according to our best opinion and by means of transport chosen by LYOPRO.

PAYMENT TERMS

The payment terms will be those agreed with our clients. Payment due dates through any legally accepted payment document must be respected promptly. Otherwise, we are entitled to charge late-payment interest, as well as losses caused by late payment. Delays in payment bring with immediate effect the cancellation of all LYOPRO commitments to the client. The buyer is not authorized to withhold all or part of the overdue payments for not having recognized any claim, since this does not exempt him from his commitment to pay. Any non-payment or delay in payment annuls the possibility of credit, paralyzing the supply of materials until the situation is regularized. If this situation is repetitive, it will proceed to notify CREDIT & SURETY, canceling the credit irrevocably.

JURISDICTION

For any questions and discrepancies arising from this operation, buyer and seller expressly submit to the jurisdiction of the judges and courts of the Courts of Valencia, waiving any other jurisdiction or reservation of ownership that may correspond.

COSTS AND EXPENSES

Legal expenses and costs, including attorney's fees and Attorney's rights, will always be borne by the contracting party that would have given rise to them due to breach of these general conditions of sale or of the contract in general.

SUPPLEMENTARY RIGHT

This sales contract will be governed by what is agreed herein and, failing that, by the rules of the Spanish Commercial Code for sales in Spain.

LEDs Y ORDENACIÓN S.L. (LYOPRO) CIF: B98495526

C/ SEQUIA DE RASCAÑA, 14, NAVE 6, 46210. PICAÑA (VALENCIA)

CONDITIONS GENERALES DE VENTE

LA FORMALISATION D'UNE COMMANDE IMPLIQUE L'ACCEPTATION DES PRESENTES CONDITIONS GENERALES DE VENTE

Toutes les ventes sont faites dans les conditions énumérées ci-dessous. Toute spécification non conforme à ces conditions devra être préalablement acceptée par écrit par LYOPRO.

DEVIS

Les budgets seront valables pendant un maximum de 30 jours calendaires à compter de la date d'émission.

GARANTIE ET QUALITÉ

Tous nos produits sont garantis (consultez la fiche technique dans chaque cas sur www.lyopro.es) contre tout défaut de fabrication. Cette garantie ne couvre pas les détériorations subies par une mauvaise utilisation ou application, une mauvaise manipulation, une mauvaise installation lorsque le produit a été utilisé au-delà de ses capacités, maltraité, heurté, ainsi que toute autre défaillance imputable au client ou au consommateur ou lorsque la défaillance est due à l'usure normale des pièces due à son fonctionnement ou à son installation. Tout matériel manipulé par du personnel non autorisé par l'entreprise est hors garantie. Les petites différences entre nos produits en termes de taille, de couleur, de qualité ou toute autre modification du produit ne pourront donner lieu à réclamation de la part de l'acheteur. Toute réclamation formulée en termes de quantité, qualité ou autres défauts sera communiquée à LYOPRO, dans un délai maximum de 48 heures à réception de la marchandise, passé ce délai ne pourra donner lieu à aucune réclamation. Pour l'exécution de la garantie par paiement ou remplacement, il est indispensable de recevoir le matériel en question afin de pouvoir l'analyser et déterminer s'il est approprié. Une exigence essentielle de toute garantie est la présentation de la facture et de la preuve de paiement et le remplissage du RMA correspondant. LYOPRO dans l'amélioration continue de la qualité et de la fonctionnalité de ses produits se réserve le droit de modifier ou de supprimer l'un quelconque de ceux-ci sans préavis sans que cela puisse constituer un motif de réclamation de la part du client.

DÉLAI DE LIVRAISON

Les délais de livraison ne sont qu'approximatifs et sans engagement, n'acceptant pas les demandes de dommages-intérêts du client pour retard de livraison, ou d'autres réclamations ou compensations pour rupture de contrat. Le non-respect du délai de livraison n'autorise pas le client à résilier le contrat d'achat sans accorder un délai raisonnable pour résoudre ledit retard (importations de matériels et produits divers (60-90 jours). Force majeure (guerres, révolutions, grèves, catastrophes naturelles, bris de machines, bris de moule ou de matrice, impossibilité d'acquérir des matières premières, interruption de transport, fermeture douanière ou toute autre mesure officielle pouvant affecter, etc.) nous donne le droit de retarder le délai de livraison sans préavis. Chaque opération est une expédition indépendante, même si plusieurs d'entre elles font partie du même ordre.

PRIX / LIVRAISON

FRET: Les conditions du prix du transport pour l'extérieur de l'Espagne seront définies à l'ouverture du dossier de chaque client.

ORDRES

Toute commande de matériel découpé ou manipulé doit être confirmée par écrit (renvoi du bon de commande envoyé par mail) avant sa mise en service. Toute commande de fabrication et de manutention supérieure à 1 500 €, le client doit régler 50 % d'avance avant le début de la fabrication (à titre de réserve). Dans toutes les demandes de matériel qui n'ont pas été faites par écrit (E-mail), LYOPRO n'est pas responsable en cas de désaccord avec ce qui a été demandé et servi. Aucune commande dont le mode de paiement est le virement ne commencera à fonctionner avant la réception du paiement.

ANNULATIONS-RETOURS DE COMMANDES

Les retours ne seront pas acceptés après 15 jours à compter de la livraison du matériel. Les commandes fermes ne peuvent être annulées sans l'accord de LYOPRO. En cas de retour pour des raisons indépendantes de la volonté de LYOPRO, le matériel sera payé avec un démerite de 20% (avec un minimum de 10€). Aucun retour de matériel ne sera accepté sans l'autorisation expresse de LYOPRO et avec le bordereau de retour complété. De même, aucun retour en port dû ne sera accepté si le motif dudit retour est une erreur LYOPRO, LYOPRO sera celui qui envoie son avis). Aucune responsabilité ou réclamation ne sera acceptée au-delà du remplacement du matériel envoyé ou de son paiement au prix auquel il a été acheté. Aucun produit fabriqué sur mesure ou apporté exprès pour le client (qui n'est pas en stock régulier) ne sera remboursé, et le client ne pourra prétendre à aucune réclamation. Toute commande spéciale, sur mesure, comportant des découpes, etc..., ne sera pas remboursable.

RÉSERVATION DE PROPRIÉTÉ

Les marchandises livrées restent notre entière propriété jusqu'au paiement. Le droit de propriété subsiste même après que l'acheteur a revendu le produit, jusqu'à ce que la dette envers LYOPRO ait été annulée.

TRANSPORT

Toute anomalie du matériel reçu ou incidence du transport doit être mentionnée sur le bon de livraison qui est signé au transporteur ou vous perdez le droit de réclamer. Le client doit ensuite nous signaler l'incident dans les 24 heures suivant la livraison, n'étant en aucun cas responsable si la réclamation est faite après à l'indiqué il appartient au client d'exercer ses recours auprès des transporteurs en cas de perte, panne ou retard de la marchandise. Le client a l'obligation d'examiner la marchandise au moment de la livraison et de relever toute anomalie. Ne pas contester le chèque ou le bon de livraison de l'agence de transport sera considéré comme conforme à celui-ci. Si le client n'a pas donné d'instructions d'expédition particulières, la marchandise sera expédiée selon notre meilleur avis et par le moyen de transport choisi par LYOPRO.

CONDITIONS DE PAIEMENT

Les conditions de paiement seront celles convenues avec nos clients. Les dates d'échéance de paiement via tout document de paiement légalement accepté doivent être respectées rapidement. Dans le cas contraire, nous sommes en droit de facturer des intérêts de retard, ainsi que les pertes causées par un retard de paiement. Les retards de paiement entraînent avec effet immédiat l'annulation de tous les engagements de LYOPRO envers le client. L'acheteur n'est pas autorisé à retenir tout ou partie des retards de paiement pour n'avoir reconnu aucune créance, dès lors que cela ne le dispense pas de son engagement de payer. Tout non-paiement ou retard de paiement annule la possibilité de crédit, paralysant l'approvisionnement en matériaux jusqu'à ce que la situation soit régularisée. Si cette situation est répétitive, il procédera à la notification de CREDIT & SURETY, annulant irrévocablement le crédit.

JURIDICTION

Pour toutes questions et divergences découlant de cette opération, l'acheteur et le vendeur se soumettent expressément à la compétence des juges et des tribunaux des tribunaux de Valence, renonçant à toute autre juridiction ou réserve de propriété qui pourrait correspondre.

COÛTS ET DÉPENSES

Les frais et dépenses judiciaires, y compris les honoraires et droits d'avocat, seront toujours à la charge du cocontractant qui les a engendrés du fait de la violation des présentes conditions générales de vente ou du contrat en général.

DROIT SUPPLÉMENTAIRE

Ce contrat de vente sera régi par ce qui est convenu ici et, à défaut, par les règles du Code de commerce espagnol pour les ventes en Espagne.

LED S Y ORDENACIÓN S.L. (LYOPRO) CIF: B98495526

C/ SEQUIA DE RASCAÑA, 14, NAVE 6, 46210. PICAÑA (VALENCIA)

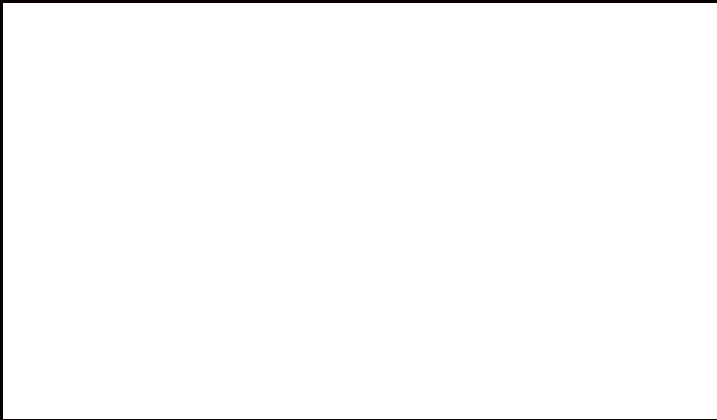

Síguenos en:

Follow us:

Suivez nous:

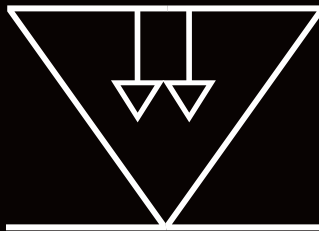

Lighting with you

CENTRO LOGÍSTICO / LOGISTICS CENTER / CENTRE LOGISTIQUE

Pol. Ind. Alquería de Moret

Sequia Rascaña, 14, nave 6 · 46210 Picaña (Valencia)

(Spain)

Telfn.: +34 963 21 50 93 · info@lyopro.es

SHOWROOM:

Avenida Tres Cruces, 63

46014 Valencia

(Spain)

www.lyopro.es