

62713R



FOTO PRODUCTO. PRODUCT PICTURE

DELIA 30W

Detalles técnicos. Technical details

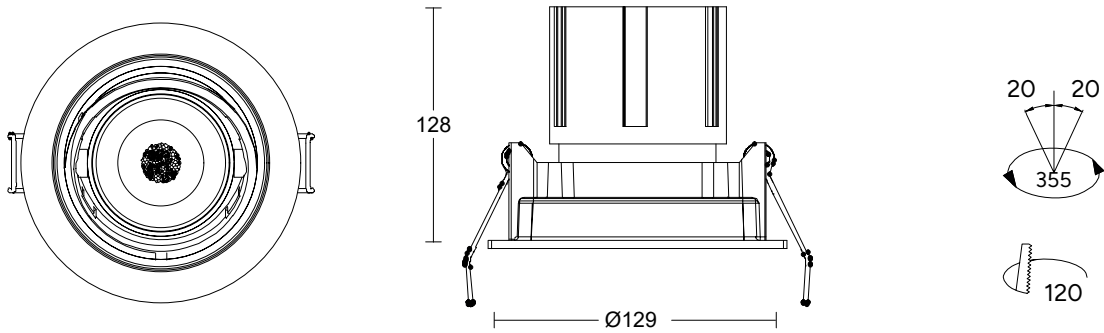

Potencia. <i>Power</i>	30W	Regulador de intensidad disponibles <i>Available dimmable</i>	ON/OFF TRIAC 1-10V DALI/PUSH
Índice de reproducción cromática. <i>Colour rendering index</i>	CRI>90		
Índice de deslumbramiento Unificado. <i>Unified Glare Rating</i>	UGR<19	Ángulo de haz disponibles <i>Available light beam angle</i>	15° 24° 36°
Temperatura de trabajo. <i>Working temperature</i>	-20° + 50°		
Protección contra sólidos y líquidos. <i>Ingress protection</i>	IP20	Lúmenes. <i>Lumens</i>	3000 Lm
Resistencia al impacto. <i>Impact resistance</i>	IK02	Temperatura de color. <i>Colour temperature</i>	3CCT: 2700-3000-4000K
Voltage	220-240V	Eficiencia. <i>Efficacy</i>	100 Lm/W
Frecuencia. <i>Frequency</i>	AC-50/60Hz	Clase. <i>Class</i>	II
SDCM	3	Vida útil. <i>Lifespan</i>	50.000 h
Led Driver	LiFud	Uso. <i>Use</i>	Interior. <i>Indoor</i>
Marca del LED. <i>Chip Brand</i>	Bridgelux	Materiales. <i>Materials</i>	Aluminio PC. <i>Aluminium PC</i>

Garantía. *Guarantee*



Normas. *Norms*

