

62713C



FOTO PRODUCTO. PRODUCT PICTURE

# DELIA 30W

## Detalles técnicos. Technical details

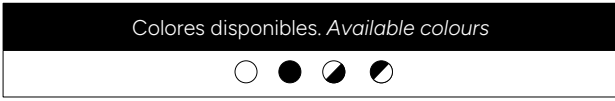
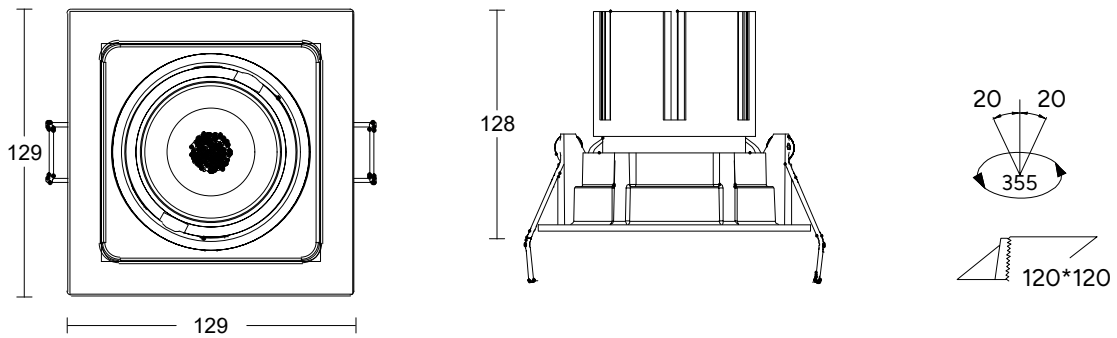

Potencia. Power	30W	Regulador de intensidad disponibles Available dimmable	ON/OFF TRIAC 1-10V DALI/PUSH
Índice de reproducción cromática. Colour rendering index	CRI>90		
Índice de deslumbramiento Unificado. Unified Glare Rating	UGR<19	Ángulo de haz disponibles Available light beam angle	15° 24° 36°
Temperatura de trabajo. Working temperature	-20° + 50°		
Protección contra sólidos y líquidos. Ingress protection	IP20	Lúmenes. Lumens	3000 Lm
Resistencia al impacto. Impact resistance	IK02	Temperatura de color. Colour temperature	3CCT: 2700-3000-4000K
Voltage	220-240V	Eficiencia. Efficacy	100 Lm/W
Frecuencia. Frequency	AC-50/60Hz	Clase. Class	II
SDCM	3	Vida útil. Lifespan	50.000 h
Led Driver	LiFud	Uso. Use	Interior. Indoor
Marca del LED. Chip Brand	Bridgelux	Materiales. Materials	Aluminio PC. Aluminium PC

Garantía. Guarantee



Normas. Norms

